

ONLY FOR CKT 3, 5, 7
OTHER DIMENSIONS REFER TO LEFT VIEWS.

RECOMMENDED PCB(CONNECTOR SIDE VIEW)
THICKNESS= 1.6 TO 2.4 MM.

QUALITY SYMBOLS FA = 0 FE = 0 FB = 0 FV = 0 FC = 0 FX = 0 FS = 0 FT = 0	THIS DRAWING CONTAINS INFORMATION THAT IS PROPRIETARY TO MOLEX ELECTRONIC TECHNOLOGIES, LLC AND SHOULD NOT BE USED WITHOUT WRITTEN PERMISSION				DIMENSION UNITS: MM SCALE: 5:1				
	EC NO: 103921 DRWN: GLLI CHK'D: GLLI APPR: AYIN	2016/03/30 2016/04/26	GENERAL TOLERANCES (UNLESS SPECIFIED) ANGULAR TOL $\pm 3.0^\circ$		DRWN BY: GLLI DATE: 2014/07/14				
	4 PLACES \pm 3 PLACES ± 0.1 2 PLACES ± 0.2 1 PLACE ± 0.3 0 PLACES \pm		DRAFT WHERE APPLICABLE MUST REMAIN WITHIN DIMENSIONS		CHK'D BY: AYIN DATE: 2015/04/08		PRODUCT CUSTOMER DRAWING		
	DRAWING SIZE: A3 THIRD ANGLE PROJECTION		SERIES: 105309 MATERIAL NUMBER: SEE SHEET 2 CUSTOMER: GENERAL MARKET		DOCUMENT NUMBER: SD-105309-100 DOC TYPE: PSD DOC PART: 000 SHEET NUMBER: 1 OF 3				
	RELEASE STATUS: P1 RELEASE DATE: 27.04.2016 07:06:58								

PART NUMBER	DIM 'A'	DIM 'B'	CKT SIZE	PLATING
105309-1202	5.94	2.50	2	GOLD 0.38
105309-1203	8.44	5.00	3	
105309-1204	10.94	7.50	4	
105309-1205	13.44	10.00	5	
105309-1206	15.94	12.50	6	
105309-1207	18.44	15.00	7	
105309-1208	20.94	17.50	8	
105309-1302	5.94	2.50	2	
105309-1303	8.44	5.00	3	
105309-1304	10.94	7.50	4	
105309-1305	13.44	10.00	5	
105309-1306	15.94	12.50	6	
105309-1307	18.44	15.00	7	
105309-1308	20.94	17.50	8	
TBD				TIN
COLOR: BLACK				

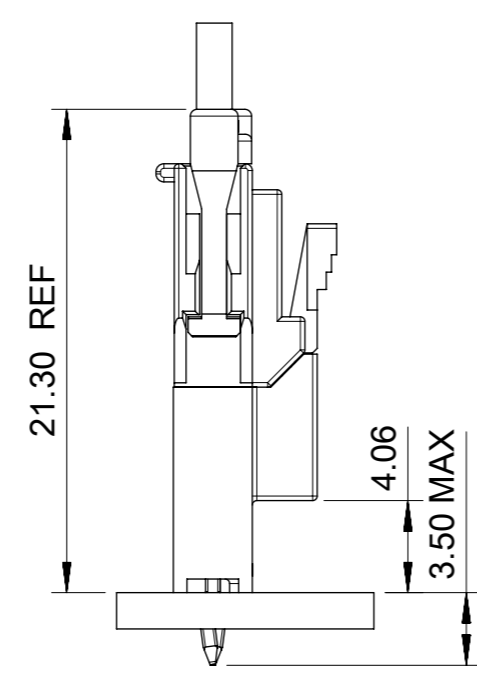

105309- * * * *
 * CIRCUIT SIZE
 * PLATING OPTION
 1 - TIN
 2 - GOLD 0.38
 3 - GOLD 0.76
 * COLOR OPTION
 1 - BLACK
 2 - NATURAL

PART NUMBER	DIM 'A'	DIM 'B'	CKT SIZE	PLATING
105309-2202	5.94	2.50	2	GOLD 0.38
105309-2203	8.44	5.00	3	
105309-2204	10.94	7.50	4	
105309-2205	13.44	10.00	5	
105309-2206	15.94	12.50	6	
105309-2207	18.44	15.00	7	
105309-2208	20.94	17.50	8	
105309-2302	5.94	2.50	2	
105309-2303	8.44	5.00	3	
105309-2304	10.94	7.50	4	
105309-2305	13.44	10.00	5	
105309-2306	15.94	12.50	6	
105309-2307	18.44	15.00	7	
105309-2308	20.94	17.50	8	
TBD				TIN
COLOR: NATURAL				







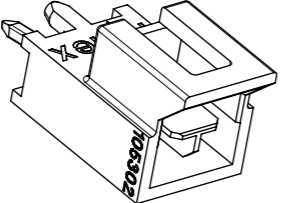
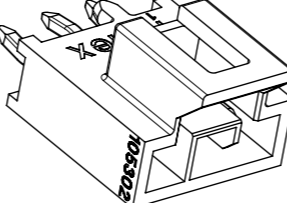
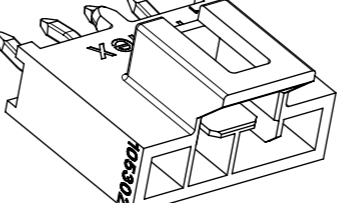
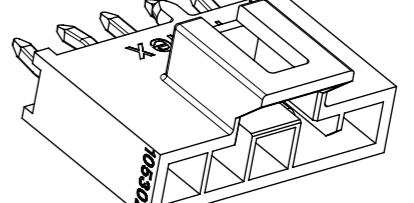
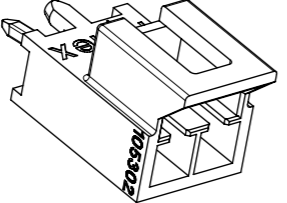
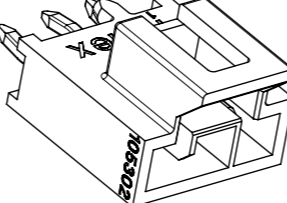
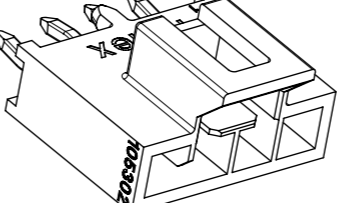
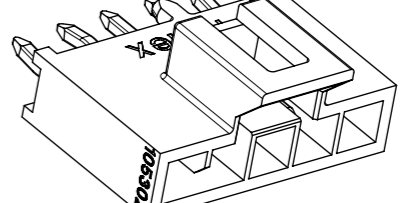
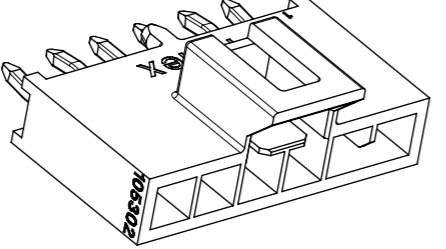
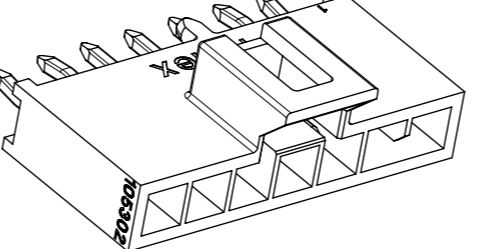
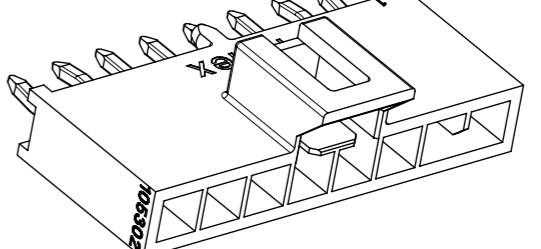
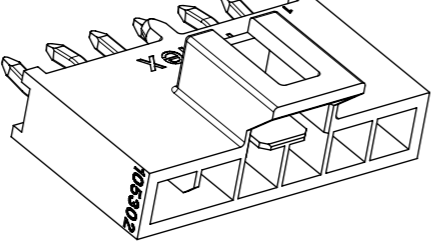
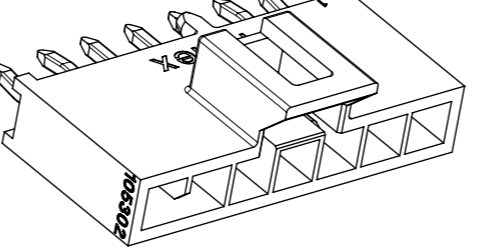
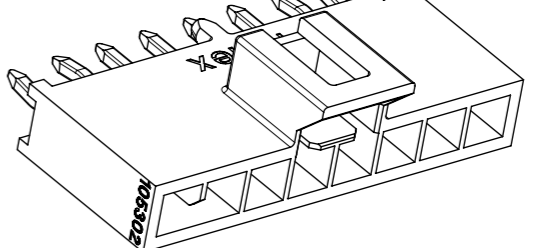

NOTES FOR ALL PARTS

1> MATERIAL:
 HOUSING: LCP; TERMINAL: BRASS; SOLDER CLIP: BRASS.
 2> PLATING FINISHED:
 TERMINAL:
 CONTACT AREA: a. TIN 1.5MICRONS MIN; b. GOLD 0.38 MICRONS MIN;
 c. GOLD 0.76 MICRONS MIN.
 SOLDER AREA: TIN 1.5 MICRONS MIN, UNDER PLATING NICKEL 1.25 MICRONS MIN.
 SOLDER CLIP: TIN 2.5 MICRONS MIN, UNDER PLATING NICKEL 1.25 MICRONS MIN.
 3> PRODUCT SPECIFICATION: PS-105300-100.

4> PACKAGE: TRAY, PK-105309-300.
 5> ALL COMPONENTS AND PRODUCT COMPLIANT TO RoHS DIRECTIVE 2011/65/EU AND ELV DIRECTIVE 2000/53/EC.
 6> PRODUCT MATE WITH SERIES OF 105308(RECEPTACLE), 105300(CRIMP TERMINAL).
 7> PARTS CONFORM TO CLASS 'B'REQUIREMENTS OF COSMETIC SPECIFICATION PS-45499-002.
 8> DISCOLORATION IN THE BANDOLIER PIN CARRIER AREA OF THE PIN IS INHERENT TO THE PLATING PROCESS AND IS DUE TO THE MASKING DEFECT OF THE CARRIER, THIS DISCOLORATION IS IN A NON-FUNCTION AREA OF THE PIN AND WILL NOT AFFECT THE PERFORMANCE OF THE HEADER ASSEMBLY.

QUALITY SYMBOLS FA = 0 FE = 0 FB = 0 FV = 0 FC = 0 FX = 0 FS = 0 FT = 0	THIS DRAWING CONTAINS INFORMATION THAT IS PROPRIETARY TO MOLEX ELECTRONIC TECHNOLOGIES, LLC AND SHOULD NOT BE USED WITHOUT WRITTEN PERMISSION				DIMENSION UNITS: MM SCALE: 3:1						
	2016/03/30	2016/04/26	GENERAL TOLERANCES (UNLESS SPECIFIED)							DRWN BY: GLLI	DATE: 2014/07/14
	EC NO: 103921 DRWN: GLLI CHK'D: AYIN APPR: AYIN	ANGULAR TOL ± 3.0 °		4 PLACES ±		CHK'D BY: AYIN	DATE: 2015/04/08	PRODUCT CUSTOMER DRAWING SERIES: 105309 MATERIAL NUMBER: SEE CHART CUSTOMER: GENERAL MARKET			
		3 PLACES ± 0.1		2 PLACES ± 0.2		DRAFT WHERE APPLICABLE MUST REMAIN WITHIN DIMENSIONS					DRAWING SIZE: A3

		2 CKT	3 CKT	4 CKT	5 CKT
E	BLACK				
D	NATURAL				
		6 CKT	7 CKT	8 CKT	
C	BLACK				
B	NATURAL				

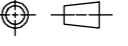
THIS DRAWING CONTAINS INFORMATION THAT IS PROPRIETARY TO MOLEX ELECTRONIC TECHNOLOGIES, LLC AND SHOULD NOT BE USED WITHOUT WRITTEN PERMISSION													
QUALITY SYMBOLS  = 0  = 0  = 0  = 0  = 0  = 0  = 0  = 0		DRWN BY: GLLI DATE: 2016/03/30 CHK'D: AYIN DATE: 2016/04/26 APPR: AYIN		GENERAL TOLERANCES (UNLESS SPECIFIED) ANGULAR TOL ± 3.0 ° 4 PLACES ± 3 PLACES ± 0.1 2 PLACES ± 0.2 1 PLACE ± 0.3 0 PLACES ± DRAFT WHERE APPLICABLE MUST REMAIN WITHIN DIMENSIONS		DIMENSION UNITS: MM SCALE: 3:1 DRWN BY: GLLI DATE: 2014/07/14 CHK'D BY: DATE: APPR BY: AYIN DATE: 2015/04/08		 HEADER OF NANO-FIT, S/R, VERTICAL, KINK POWER CONNECTOR			PRODUCT CUSTOMER DRAWING		
EC NO: 103921 DRWN: GLLI CHK'D: AYIN APPR: AYIN		EC NO: 103921 DRWN: GLLI CHK'D: AYIN APPR: AYIN		DRAFT WHERE APPLICABLE MUST REMAIN WITHIN DIMENSIONS		DRAWING SIZE: A3 THIRD ANGLE PROJECTION: 		SERIES: 105309	MATERIAL NUMBER: SEE SHEET 2		CUSTOMER: GENERAL MARKET		
DOCUMENT NUMBER: SD-105309-100				DOC TYPE: PSD	DOC PART: 000	SHEET NUMBER: 3 OF 3							