

THIS DOCUMENT IS THE PROPERTY OF
 KEYSTONE ELECTRONICS CORP. AND
 SHALL NOT BE REPRODUCED, DISTRIBUTED
 OR USED AS A BASIS FOR MANUFACTURE
 WITHOUT PRIOR WRITTEN PERMISSION
 FROM KEYSTONE ELECTRONICS CORP.

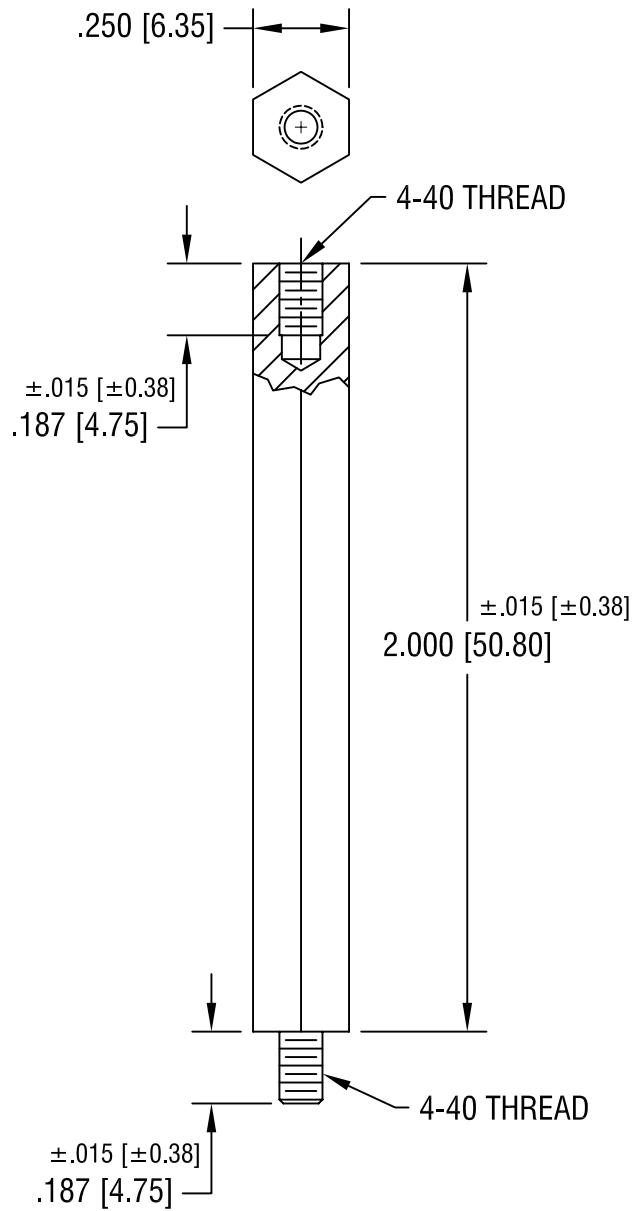

KEYSTONE ELECTRONICS CORP.

ASTORIA, N.Y. 11105-2017

PART NAME

NYLON M/F HEX STANDOFF

MATERIAL

NYLON 6/6

FINISH

-

DRN BY

BOONE

DATE

10.4.94

APP'D

LN

SCALE

2X

TOLERANCES

INCH [MM]

CODE

DWG NO.

DECIMAL ±.005 [±0.15]

C/M

ANGULAR ± 1°
 UNLESS OTHERWISE SPECIFIED

4813

DATE	DESCRIPTION	REV.