

### FEATURES

- Dual axis accelerometer on a single IC chip
- 5 mm × 5 mm × 2 mm LCC package
- 5 mg resolution at 60 Hz
- Low power: 700  $\mu$ A at  $V_S = 5$  V (typical)
- High zero  $g$  bias stability
- High sensitivity accuracy
- Pulse width modulated digital outputs
- X- and Y-axis aligned to within  $0.1^\circ$  (typical)
- Bandwidth adjustment with a single capacitor
- Single-supply operation
- 3500  $g$  shock survival

### APPLICATIONS

- Automotive tilt alarms
- Vehicle dynamic control (VDC)/electronic stability program (ESP) systems
- Electronic chassis control
- Electronic braking
- Data projectors
- Navigation
- Platform stabilization/leveling
- Alarms and motion detectors
- High accuracy, 2-axis tilt sensing

### GENERAL DESCRIPTION

The ADXL212 is a high precision, low power, complete dual axis accelerometer with signal conditioned, duty cycle modulated outputs, all on a single monolithic IC. The ADXL212 measures acceleration with a full-scale range of  $\pm 2 g$  (typical). The ADXL212 measures both dynamic acceleration (such as vibration) and static acceleration (such as gravity).

The outputs are digital signals whose duty cycles (ratio of pulse width to period) are proportional to acceleration ( $12.5\%/g$ ) in each of the two sensitive axes. The duty cycle outputs can be directly measured by a microcontroller without an analog-to-digital converter (ADC) or glue logic. The output period is adjustable from 0.5 ms to 10 ms via a single resistor ( $R_{SET}$ ).

The typical noise floor is  $500 \mu g/\sqrt{Hz}$ , allowing signals below 5 mg ( $0.3^\circ$  of inclination) to be resolved in tilt sensing applications using narrow bandwidths ( $<60$  Hz).

The user selects the bandwidth of the accelerometer using Capacitors  $C_X$  and  $C_Y$  at the  $X_{FILT}$  and  $Y_{FILT}$  pins. Bandwidths of 0.5 Hz to 500 Hz can be selected to suit the application.

The ADXL212 is available in a 5 mm × 5 mm × 2 mm, 8-lead hermetic LCC package.

### FUNCTIONAL BLOCK DIAGRAM

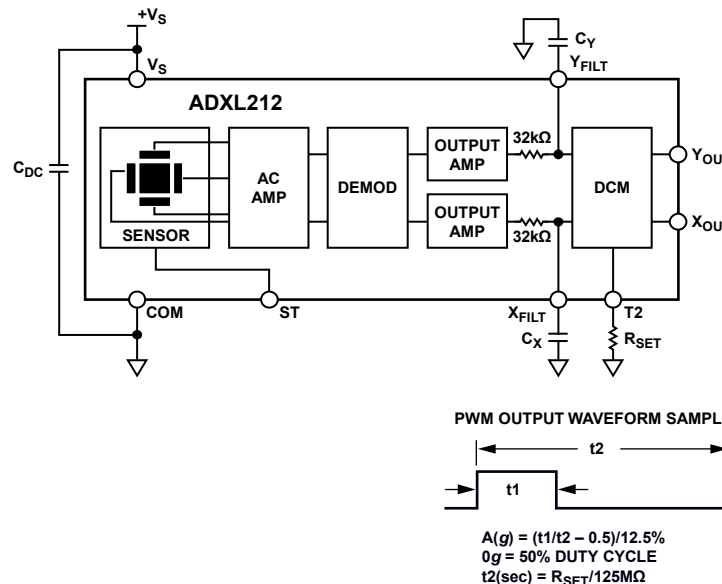

Figure 1.

#### Rev. 0

Information furnished by Analog Devices is believed to be accurate and reliable. However, no responsibility is assumed by Analog Devices for its use, nor for any infringements of patents or other rights of third parties that may result from its use. Specifications subject to change without notice. No license is granted by implication or otherwise under any patent or patent rights of Analog Devices. Trademarks and registered trademarks are the property of their respective owners.

# ADXL212\* PRODUCT PAGE QUICK LINKS

Last Content Update: 02/23/2017

---

## COMPARABLE PARTS

View a parametric search of comparable parts.

## EVALUATION KITS

- ADXL212 Evaluation Board

## DOCUMENTATION

### Data Sheet

- ADXL212: Precision  $\pm 2$  g Dual Axis, PWM Output Accelerometer

### User Guides

- UG-315: Evaluating the  $\pm 2$  g, Dual Axis, PWM Output Accelerometer

## DESIGN RESOURCES

- ADXL212 Material Declaration
- PCN-PDN Information
- Quality And Reliability
- Symbols and Footprints

## DISCUSSIONS

View all ADXL212 EngineerZone Discussions.

## SAMPLE AND BUY

Visit the product page to see pricing options.

## TECHNICAL SUPPORT

Submit a technical question or find your regional support number.

## DOCUMENT FEEDBACK

Submit feedback for this data sheet.

---

## TABLE OF CONTENTS

Features .....	1	Applications Information .....	10
Applications.....	1	Power Supply Decoupling .....	10
General Description .....	1	Setting the Bandwidth Using $C_X$ and $C_Y$ .....	10
Functional Block Diagram .....	1	Self Test .....	10
Revision History .....	2	Design Trade-Offs for Selecting Filter Characteristics: Noise vs. Bandwidth .....	10
Specifications.....	3	Using the ADXL212 with Operating Voltages Other Than 5 V .....	11
Absolute Maximum Ratings.....	4	Using the ADXL212 as a Dual Axis Tilt Sensor .....	11
Thermal Resistance .....	4	Outline Dimensions .....	12
ESD Caution.....	4	Ordering Guide .....	12
Pin Configuration and Function Descriptions.....	5		
Typical Performance Characteristics .....	6		
Theory of Operation .....	9		
Performance .....	9		

## REVISION HISTORY

5/11—Revision 0: Initial Version

## SPECIFICATIONS

$T_A = -40^{\circ}\text{C}$  to  $+85^{\circ}\text{C}$ ,  $V_S = 5\text{ V}$ ,  $C_X = C_Y = 0.1\ \mu\text{F}$ , acceleration =  $0\text{ g}$ , unless otherwise noted. All minimum and maximum specifications are guaranteed. Typical specifications are not guaranteed.

**Table 1.**

Parameter	Test Conditions/Comments	Min	Typ	Max	Unit
SENSOR INPUT	Each axis				
Measurement Range <sup>1</sup>		$\pm 1.5$	$\pm 2$		g
Nonlinearity	Best fit straight line		$\pm 0.2$		% of FS
Package Alignment Error			$\pm 1$		Degrees
Alignment Error	X sensor to Y sensor		$\pm 0.01$		Degrees
Cross Axis Sensitivity			$\pm 2$		%
SENSITIVITY (RATIOMETRIC) <sup>2</sup>	Each axis				
Sensitivity at $X_{OUT}$ , $Y_{OUT}$	$V_S = 5\text{ V}$	10	12.5	15	%/g
Sensitivity Change Due to Temperature <sup>3</sup>	$V_S = 5\text{ V}$		$\pm 0.5$		%
ZERO g BIAS LEVEL (RATIOMETRIC)	Each axis				
0 g Duty Cycle at $X_{OUT}$ , $Y_{OUT}$		25	50	75	%
Initial 0 g Output Deviation from Ideal	$T_A = 25^{\circ}\text{C}$		$\pm 2$		%
0 g Duty Cycle vs. Supply			1.0	4.0	%/V
0 g Offset vs. Temperature			$\pm 2$		mg/ $^{\circ}\text{C}$
NOISE PERFORMANCE					
Noise Density	$T_A = 25^{\circ}\text{C}$		500	1000	$\mu\text{g}/\sqrt{\text{Hz}}$ rms
FREQUENCY RESPONSE <sup>4</sup>					
3 dB Bandwidth <sup>5</sup>			500		Hz
$C_X$ , $C_Y$ Range <sup>5</sup>		0.002		4.7	$\mu\text{F}$
Sensor Resonant Frequency			5.5		kHz
SELF TEST <sup>6</sup>					
Duty Cycle Change	Self test (ST) pin: pulled low (0) to high (1)		10		%
DUTY CYCLE OUTPUT STAGE					
$f_{SET}$ <sup>7</sup>	$R_{SET} = 125\text{ k}\Omega$		1		kHz
$f_{SET}$ <sup>7</sup> Tolerance	$R_{SET} = 125\text{ k}\Omega$	0.7		1.3	kHz
Voltage Levels					
High	$I = 25\ \mu\text{A}$		$V_S - 0.2$		V
Low	$I = 25\ \mu\text{A}$			200	mV
t2 Drift vs. Temperature			$\pm 35$		ppm/ $^{\circ}\text{C}$
Rise/Fall Time			200		ns
POWER SUPPLY					
Operating Voltage Range		3.0		5.25	V
Specified Performance		4.75		5.25	V
Quiescent Supply Current			0.7	1.1	mA
Turn-On Time <sup>8</sup>			19		ms
TEMPERATURE RANGE					
Specified Performance		-40		+85	$^{\circ}\text{C}$

<sup>1</sup> Guaranteed by measurement of initial offset and sensitivity.

<sup>2</sup> Sensitivity varies with  $V_S$ . At  $V_S = 3\text{ V}$ , sensitivity is typically 7.5%/g.

<sup>3</sup> Defined as the output change from ambient-to-maximum temperature or ambient-to-minimum temperature.

<sup>4</sup> Actual frequency response is controlled by a user supplied external capacitor ( $C_X$ ,  $C_Y$ ).

<sup>5</sup> Bandwidth =  $1/(2 \times \pi \times 32\text{ k}\Omega \times C)$ . For  $C_X$ ,  $C_Y = 0.002\ \mu\text{F}$ , bandwidth = 2500 Hz. For  $C_X$ ,  $C_Y = 4.7\ \mu\text{F}$ , bandwidth = 1 Hz. Minimum/maximum values are not tested.

<sup>6</sup> Self test response changes with  $V_S$ . At  $V_S = 3\text{ V}$ , self test output is typically 6%.

<sup>7</sup> The value of  $f_{SET}$  is defined by the following equation:

$$f_{SET} = \frac{1}{t2}$$

<sup>8</sup> Larger values of  $C_X$ ,  $C_Y$  increase turn-on time. Turn-on time is approximately  $160 \times C_X$  or  $C_Y + 3$ , where  $C_X$ ,  $C_Y$  are in  $\mu\text{F}$ , and the resulting turn-on time is in ms.

## ABSOLUTE MAXIMUM RATINGS

Table 2.

Parameter	Rating
Acceleration (Any Axis, Unpowered)	1000 g
Acceleration (Any Axis, Powered)	1000 g
$V_s$	-0.3 V to +7.0 V
Output Short-Circuit Duration (Any Pin to Common)	Indefinite
Operating Temperature Range	-55°C to +125°C
Storage Temperature Range	-65°C to +150°C

Stresses above those listed under Absolute Maximum Ratings may cause permanent damage to the device. This is a stress rating only; functional operation of the device at these or any other conditions above those indicated in the operational section of this specification is not implied. Exposure to absolute maximum rating conditions for extended periods may affect device reliability.

## THERMAL RESISTANCE

$\theta_{JA}$  is specified for the worst-case conditions, that is, a device soldered in a circuit board for surface-mount packages.

Table 3. Thermal Resistance

Package Type	$\theta_{JA}$	$\theta_{JC}$	Device Weight
8-Lead Ceramic LCC	120°C/W	20°C/W	<1.0 g

## ESD CAUTION



**ESD (electrostatic discharge) sensitive device.** Charged devices and circuit boards can discharge without detection. Although this product features patented or proprietary protection circuitry, damage may occur on devices subjected to high energy ESD. Therefore, proper ESD precautions should be taken to avoid performance degradation or loss of functionality.

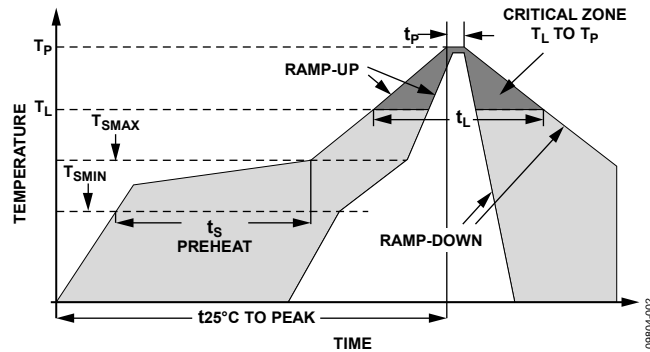

Figure 2. Recommended Soldering Profile

Table 4. Soldering Profile

Profile Feature	Condition	
	Sn63/Pb37	Pb Free
Average Ramp Rate ( $T_L$ to $T_P$ )	3°C/sec maximum	
Preheat		
Minimum Temperature ( $T_{SMIN}$ )	100°C	150°C
Minimum Temperature ( $T_{SMAX}$ )	150°C	200°C
Time ( $T_{SMIN}$ to $T_{SMAX}$ ) ( $t_s$ )	60 sec to 120 sec	60 sec to 150 sec
$T_{SMAX}$ to $T_L$		
Ramp-Up Rate	3°C/sec maximum	
Time ( $t_L$ ) Maintained Above Liquidous ( $T_L$ )		
Liquidous Temperature ( $T_L$ )	183°C	217°C
Time ( $t_L$ )	60 sec to 150 sec	60 sec to 150 sec
Peak Temperature ( $T_P$ )	240°C +0°C/-5°C	260°C +0°C/-5°C
Time Within 5°C of Actual Peak Temperature ( $t_p$ )	10 sec to 30 sec	20 sec to 40 sec
Ramp-Down Rate	6°C/sec maximum	
Time 25°C to Peak Temperature	6 minutes maximum	8 minutes maximum

## PIN CONFIGURATION AND FUNCTION DESCRIPTIONS

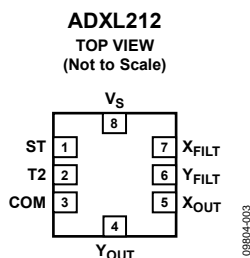

Figure 3. Pin Configuration

Table 5. Pin Function Descriptions

Pin No.	Mnemonic	Description
1	ST	Self Test.
2	T2	Frequency Set. Connect the R <sub>SET</sub> resistor to ground. $t2 = R_{SET}/125 \text{ M}\Omega$ See the Theory of Operation section for details.
3	COM	Common.
4	Y <sub>OUT</sub>	Y Channel Output.
5	X <sub>OUT</sub>	X Channel Output.
6	Y <sub>FILT</sub>	Y Channel Filter Pin.
7	X <sub>FILT</sub>	X Channel Filter Pin.
8	V <sub>S</sub>	Voltage Supply. 3 V to 5.25 V.

## TYPICAL PERFORMANCE CHARACTERISTICS

$V_s = 5\text{ V}$ , unless otherwise noted.

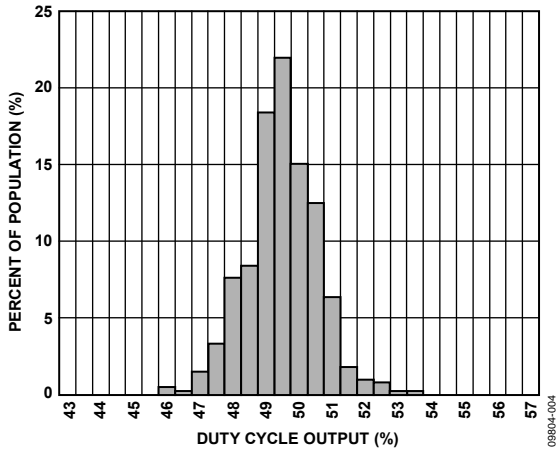

Figure 4. X-Axis Zero g Bias Deviation from Ideal at 25°C

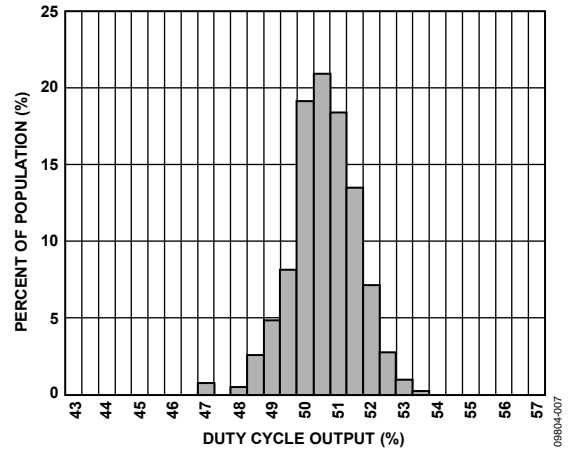

Figure 7. Y-Axis Zero g Bias Deviation from Ideal at 25°C

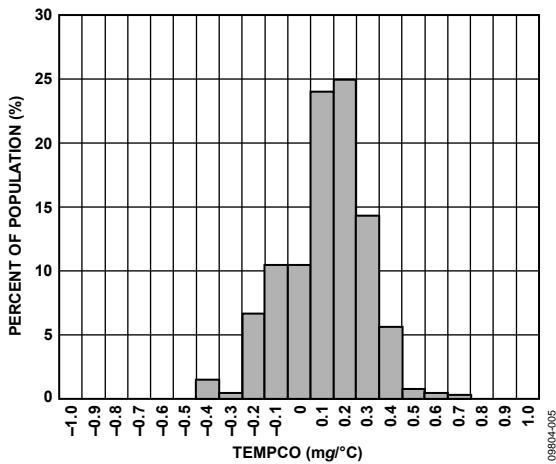

Figure 5. X-Axis Zero g Bias Tempco

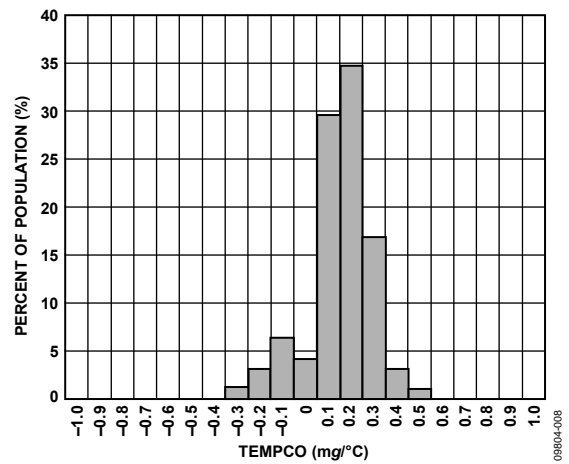

Figure 8. Y-Axis Zero g Bias Tempco

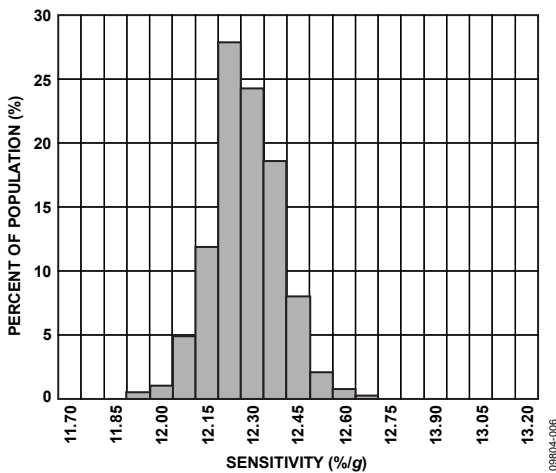

Figure 6. X-Axis Sensitivity at 25°C

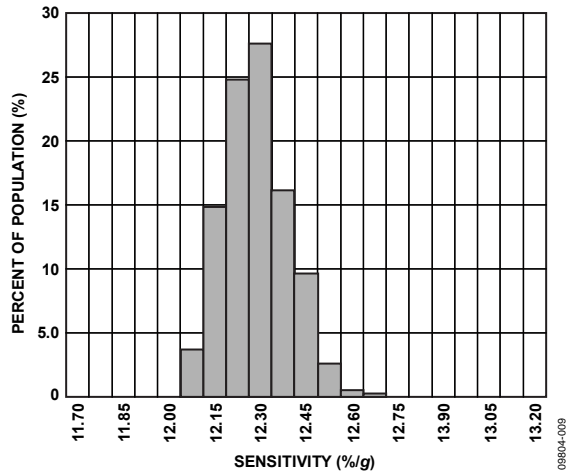

Figure 9. Y-Axis Sensitivity at 25°C

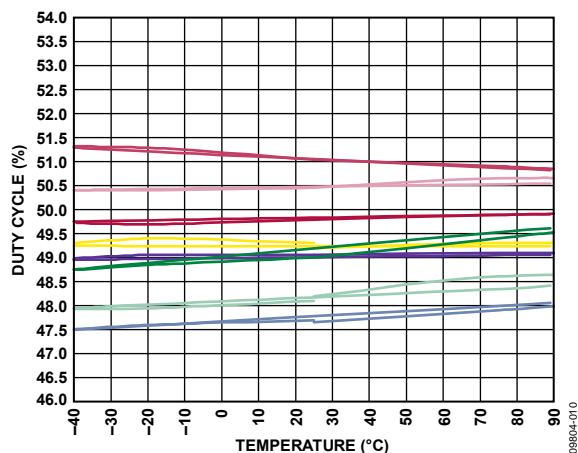

Figure 10. Zero g Bias vs. Temperature, Parts Soldered to PCB

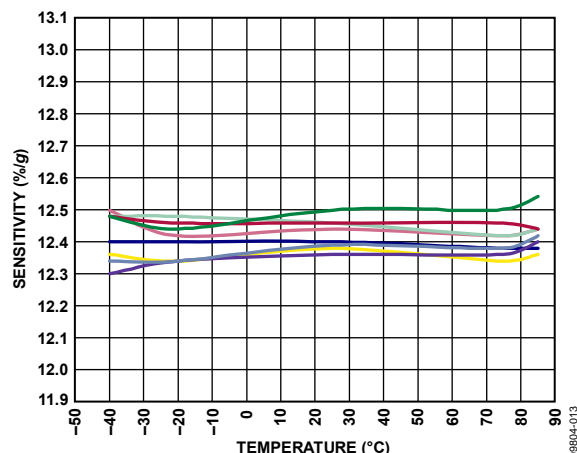

Figure 13. Sensitivity vs. Temperature, Parts Soldered to PCB

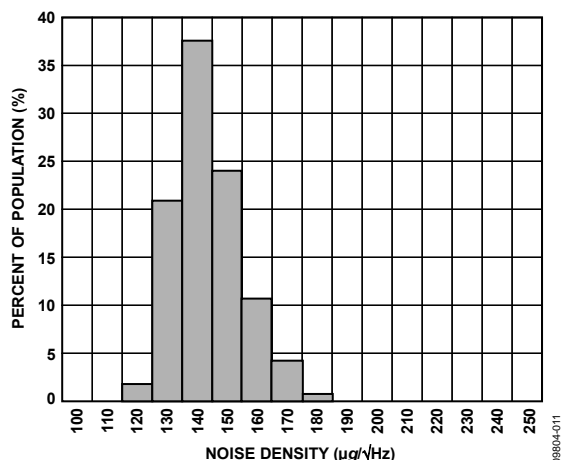

Figure 11. X-Axis Noise Density at 25°C

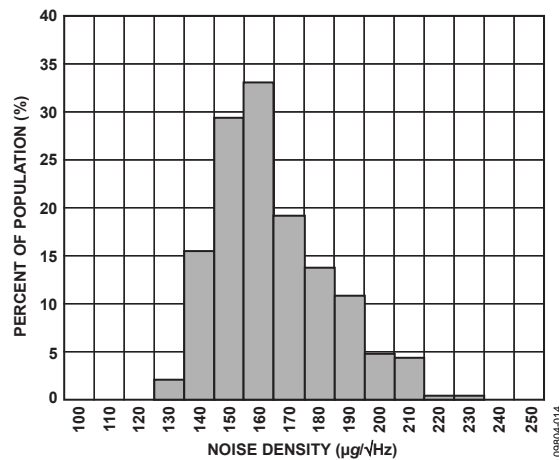

Figure 14. Y-Axis Noise Density at 25°C

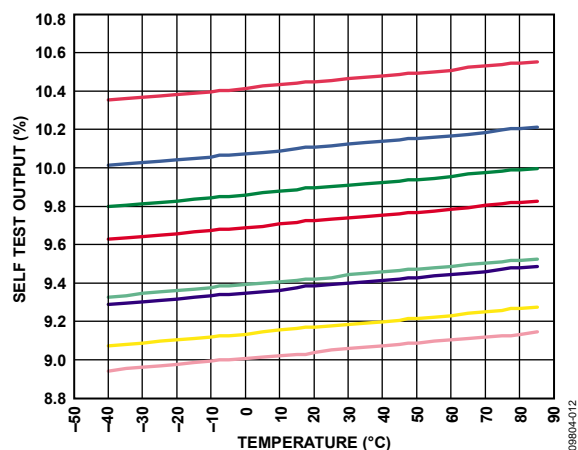

Figure 12. Self Test Response vs. Temperature

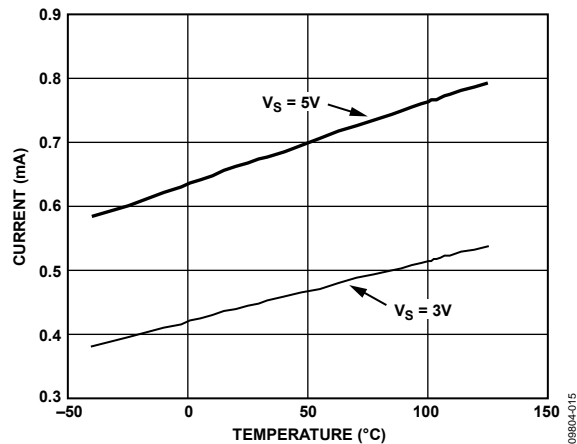

Figure 15. Supply Current vs. Temperature



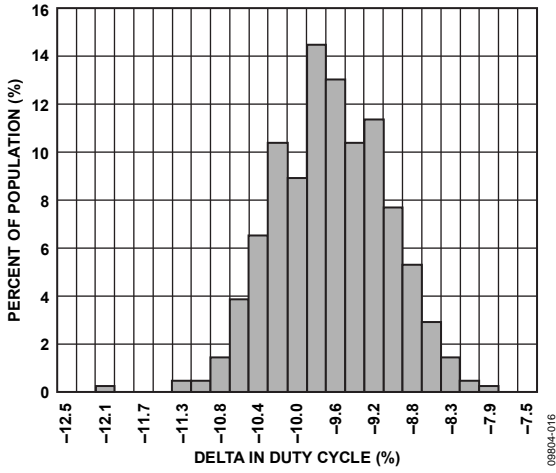

Figure 16. X-Axis Self Test Response at 25°C

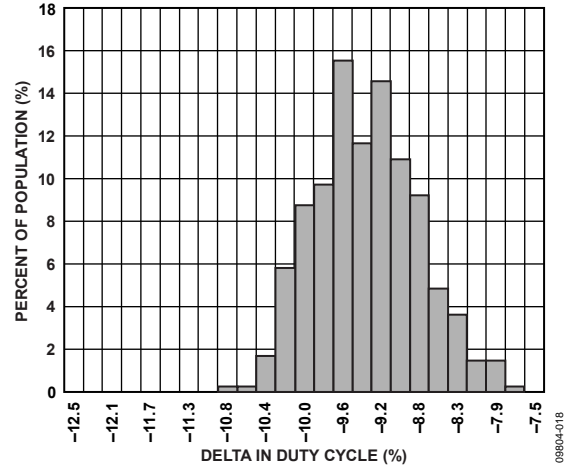

Figure 18. Y-Axis Self Test Response at 25°C

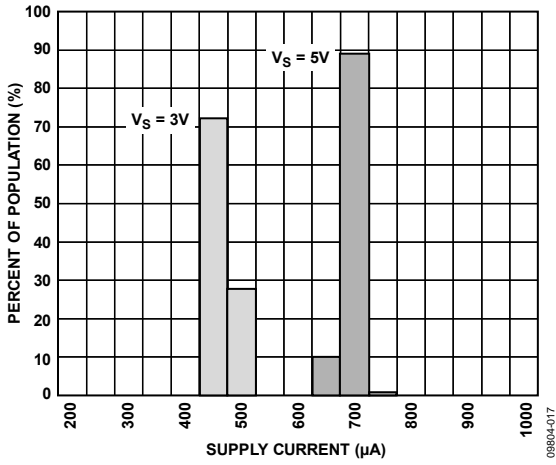

Figure 17. Supply Current at 25°C

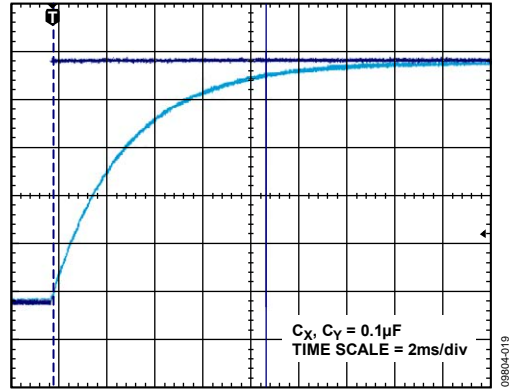

Figure 19. Turn-On Time

## THEORY OF OPERATION

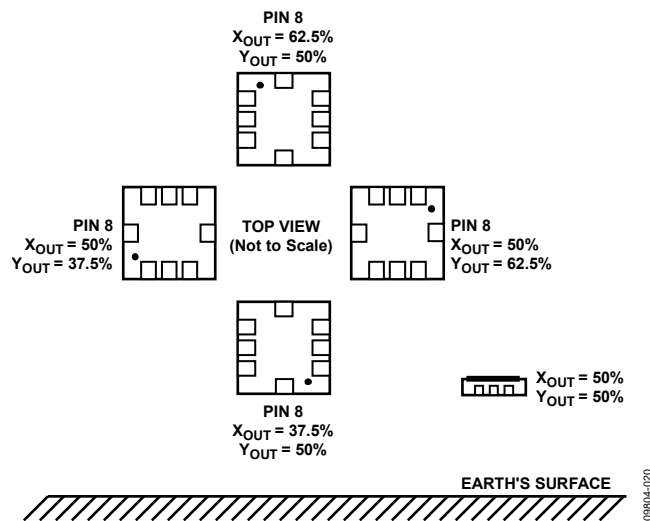

Figure 20. Output Response vs. Orientation

The ADXL212 is a complete dual axis acceleration measurement system on a single monolithic IC. It contains a polysilicon surface-micromachined sensor and signal conditioning circuitry to implement an open-loop acceleration measurement architecture. The output signals are duty cycle modulated digital signals proportional to the acceleration. The ADXL212 is capable of measuring both positive and negative accelerations to  $\pm 2$  g. The accelerometer can measure static acceleration forces such as gravity, allowing the ADXL212 to be used as a tilt sensor.

The sensor is a surface-micromachined polysilicon structure built on top of a silicon wafer. Polysilicon springs suspend the structure over the surface of the wafer and provide a resistance against acceleration forces. Deflection of the structure is measured using a differential capacitor that consists of independent fixed plates and plates attached to the moving mass. The fixed plates are driven by 180° out-of-phase square waves. Acceleration deflects the beam and unbalances the differential capacitor, resulting in an output square wave with an amplitude that is proportional to acceleration. Phase sensitive demodulation techniques are used to rectify the signal and determine the direction of the acceleration.

The output of the demodulator is amplified and brought off chip through a 32 k $\Omega$  resistor, at which point the user can set the signal bandwidth of the device by adding a capacitor. This filtering improves measurement resolution and helps prevent aliasing.

After being low-pass filtered, the analog signals are converted to duty cycle modulated outputs that can be read by a counter.

A single resistor ( $R_{SET}$ ) sets the period for a complete cycle ( $t_2$ ) according to the following equation:

$$t_2 \text{ (nominal)} = R_{SET} / 125 \text{ M}\Omega$$

A 0 g acceleration produces a 50% nominal duty cycle. The acceleration can be determined by measuring the length of the positive pulse width ( $t_1$ ) and the period ( $t_2$ ). The nominal transfer function of the ADXL212 is

$$\text{Acceleration} = ((t_1/t_2) - \text{Zero g Bias}) / \text{Sensitivity}$$

where:

Zero g Bias = 50% nominal.

Sensitivity = 12.5%/g nominal.

### PERFORMANCE

High performance is built into the device through innovative design techniques rather than by using additional temperature compensation circuitry. As a result, there is essentially no quantization error or nonmonotonic behavior, and temperature hysteresis is very low (typically less than 10 mg over the  $-40^\circ\text{C}$  to  $+85^\circ\text{C}$  temperature range).

Figure 10 shows the zero g output performance of eight parts (x-axis and y-axis) over a  $-40^\circ\text{C}$  to  $+85^\circ\text{C}$  temperature range.

Figure 13 demonstrates the typical sensitivity shift over temperature for  $V_s = 5$  V. Sensitivity stability is optimized for  $V_s = 5$  V but remains very good over the specified range; it is typically better than  $\pm 2\%$  over temperature at  $V_s = 3$  V.

## APPLICATIONS INFORMATION

### POWER SUPPLY DECOUPLING

For most applications, a single 0.1  $\mu\text{F}$  capacitor,  $C_{\text{DC}}$ , adequately decouples the accelerometer from noise on the power supply. However, in some cases, particularly where noise is present at the 140 kHz internal clock frequency (or any harmonic thereof), noise on the supply may cause interference on the output of the ADXL212. If additional decoupling is needed, insert a 100  $\Omega$  (or smaller) resistor or ferrite beads in the supply line of the ADXL212. In addition or as an alternative to adding the resistor or ferrite beads, a larger bulk bypass capacitor (in the range of 1  $\mu\text{F}$  to 22  $\mu\text{F}$ ) can be added in parallel to  $C_{\text{DC}}$ .

### SETTING THE BANDWIDTH USING $C_X$ AND $C_Y$

The ADXL212 has provisions for band limiting the  $X_{\text{OUT}}$  and  $Y_{\text{OUT}}$  pins. Capacitors must be added at these pins to implement low-pass filtering for antialiasing and noise reduction. The equation for the 3 dB bandwidth is

$$f_{3\text{dB}} = 1/(2\pi(32\text{ k}\Omega) \times C_{(X,Y)})$$

or more simply,

$$f_{3\text{dB}} = 5\ \mu\text{F}/C_{(X,Y)}$$

The tolerance of the internal resistor ( $R_{\text{FILT}}$ ) can vary typically as much as  $\pm 25\%$  of its nominal value (32 k $\Omega$ ); the bandwidth varies accordingly. A minimum capacitance of 2000 pF for  $C_X$  and  $C_Y$  is required in all cases.

**Table 6. Filter Capacitor Selection,  $C_X$  and  $C_Y$**

Bandwidth (Hz)	Capacitor ( $\mu\text{F}$ )
1	4.7
10	0.47
50	0.10
100	0.05
200	0.027
500	0.01

### SELF TEST

The ST pin controls the self test feature. When this pin is set to  $V_S$ , an electrostatic force is exerted on the beam of the accelerometer. The resulting movement of the beam allows the user to test if the accelerometer is functional. The typical change in output is 750 mg (corresponding to a duty cycle of 10%) and is additive to the accelerometer outputs. The ST pin can remain open circuit, or it can be connected to ground in normal use.

Never expose the ST pin to voltages greater than  $V_S + 0.3\text{ V}$ . If the system design is such that this condition cannot be guaranteed (that is, multiple supply voltages are present), a low  $V_F$  clamping diode between ST and  $V_S$  is recommended.

### DESIGN TRADE-OFFS FOR SELECTING FILTER CHARACTERISTICS: NOISE vs. BANDWIDTH

The chosen accelerometer bandwidth ultimately determines the measurement resolution (smallest detectable acceleration). Filtering can be used to lower the noise floor, which improves the resolution of the accelerometer. Resolution is dependent on the analog filter capacitors at  $X_{\text{FILT}}$  and  $Y_{\text{FILT}}$ .

The ADXL212 has a typical PWM bandwidth of 500 Hz. The user must filter the signal to a bandwidth lower than 500 Hz to limit aliasing errors.

The ADXL212 noise has the characteristics of white Gaussian noise, which contributes equally at all frequencies and is described in terms of  $\mu\text{g}/\sqrt{\text{Hz}}$  (that is, the noise is proportional to the square root of the accelerometer bandwidth). To maximize the resolution and dynamic range of the accelerometer, limit bandwidth to the lowest frequency needed by the application.

With the single pole roll-off characteristic, the typical noise of the ADXL212 is determined by

$$\text{rms Noise} = (500\ \mu\text{g}/\sqrt{\text{Hz}}) \times (\sqrt{BW \times 1.6})$$

At 100 Hz, the noise is

$$\text{rms Noise} = (500\ \mu\text{g}/\sqrt{\text{Hz}}) \times (\sqrt{100 \times 1.6}) = 6.3\text{ mg}$$

Often, the peak value of the noise is desired. Peak-to-peak noise can only be estimated by statistical methods. Table 7 is useful for estimating the probabilities of exceeding various peak values, given the rms value.

**Table 7. Estimation of Peak-to-Peak Noise**

Peak-to-Peak Value	% of Time that Noise Exceeds Nominal Peak-to-Peak Value
2 $\times$ rms	32
4 $\times$ rms	4.6
6 $\times$ rms	0.27
8 $\times$ rms	0.006

For example, at 100 Hz bandwidth, peak noise exceeds 25.2 mg 4.6% of the time.

Peak-to-peak noise values provide the best estimate of the uncertainty in a single measurement. Table 8 lists the typical noise output of the ADXL212 for various  $C_X$  and  $C_Y$  values.

**Table 8. Filter Capacitor Selection ( $C_X$ ,  $C_Y$ )**

Bandwidth(Hz)	$C_X$ , $C_Y$ ( $\mu\text{F}$ )	RMS Noise (mg)	Peak-to-Peak Noise Estimate (mg)
10	0.47	0.64	3.8
50	0.1	1.4	8.6
100	0.047	2	12
500	0.01	4.5	27.2

### USING THE ADXL212 WITH OPERATING VOLTAGES OTHER THAN 5 V

The ADXL212 is tested and specified at  $V_S = 5\text{ V}$ ; however, it can be powered with  $V_S$  as low as 3 V or as high as 5.25 V. Some performance parameters change as the supply voltage varies.

The ADXL212 sensitivity varies proportionally to supply voltage. At  $V_S = 3\text{ V}$ , the sensitivity is typically 7.5%/g.

The zero g bias output is ratiometric to supply voltage; therefore, the zero g output is nominally equal to 50% at all supply voltages.

Self test response in g is roughly proportional to the square of the supply voltage. Therefore, at  $V_S = 3\text{ V}$ , the self test response is equivalent to approximately 270 mg (typical), or 6%.

The supply current decreases as the supply voltage decreases. Typical current consumption at  $V_{DD} = 3\text{ V}$  is 450  $\mu\text{A}$ .

### USING THE ADXL212 AS A DUAL AXIS TILT SENSOR

A common application of the ADXL212 is tilt measurement. An accelerometer uses the force of gravity as an input vector to determine its orientation in space.

An accelerometer is most sensitive to tilt when its sensitive axis is perpendicular to the force of gravity, that is, parallel to the surface of the earth. At this orientation, its response to changes in tilt is highest: its output changes nearly 17.5 mg per degree of tilt. When the accelerometer is oriented on axis to gravity, that is, near its +1 g or -1 g reading, the change in output acceleration per degree of tilt is negligible. At 45°, its output changes by 12.2 mg per degree.

#### **Dual Axis Tilt Sensor: Converting Acceleration to Tilt**

When the accelerometer is oriented with both its x-axis and y-axis parallel to the surface of the earth (reading approximately 0 g), it can be used as a dual axis tilt sensor with a roll axis and a pitch axis. The output tilt in degrees is calculated as follows:

$$\text{Pitch} = \text{ASIN}(A_X/1\text{ g})$$

$$\text{Roll} = \text{ASIN}(A_Y/1\text{ g})$$

where  $A_X$  and  $A_Y$  are accelerations in g, ranging from -1 g to +1 g.

Be sure to account for overranges. It is possible for the accelerometers to output a signal greater than  $\pm 1\text{ g}$  due to vibration, shock, or other accelerations.

# ADXL212

## OUTLINE DIMENSIONS

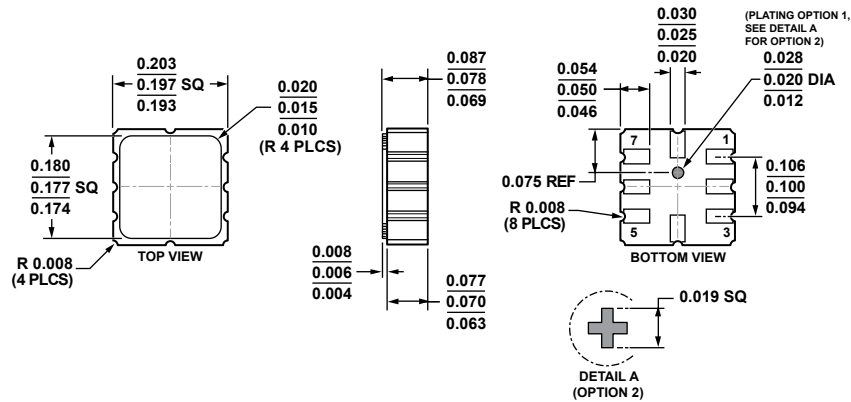

Figure 21. 8-Terminal Ceramic Leadless Chip Carrier [LCC]  
(E-8-1)

Dimensions shown in inches

### ORDERING GUIDE

Model <sup>1</sup>	Number of Axes	Specified Voltage (V)	Temperature Range	Package Description	Package Option
ADXL212AEZ	2	5	-40°C to +85°C	8-Terminal Ceramic Leadless Chip Carrier [LCC]	E-8-1
ADXL212AEZ-RL	2	5	-40°C to +85°C	8-Terminal Ceramic Leadless Chip Carrier [LCC]	E-8-1
EVAL-ADXL212Z				Evaluation Board	

<sup>1</sup> Z = RoHS Compliant Part.