

AMMC-6630

5 – 45 GHz Variable Attenuator



Data Sheet

Description

The AMMC-6630 MMIC is a monolithic, voltage variable, GaAs IC attenuator that operates from 5-45 GHz. It is fabricated using Avago Technologies enhancement mode MMIC process with backside ground vias, and gate lengths of approximately 0.25um. The attenuator has a distributed topology and it helps to absorb parasitic effects of its series and shunt FETs to make it broadband.

AMMC-6630 MMIC

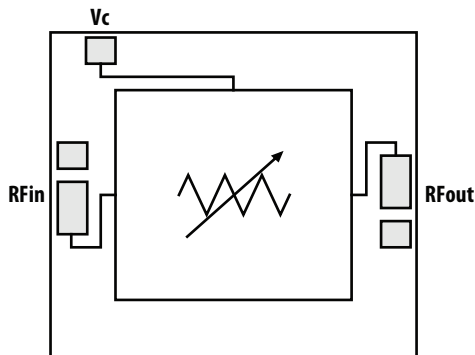

Chip Size: 1450 μm x 1735 μm (57 x 68.5 mils)
Chip Size Tolerance: ± 10 μm (± 0.4 mils)
Chip Thickness: 100 \pm 10 μm (4 \pm 0.4 mils)
Minimum Pad Dimension: 80 x 120 μm (3.4 x 4 mils)

Features

- Wide Frequency Range 5-45 GHz
- Attenuation Range 20dB
- Positive Single Pin Control Voltage
- Unconditionally Stable

Applications

- Microwave Radio Systems
- Satellite VSAT, DBS Up / Down Link
- LMDS & Pt – Pt mmW Long Haul
- Broadband Wireless Access (including 802.16 and 802.20 WiMax)
- WLL and MMDS loops



Attention: Observe Precautions for handling electrostatic sensitive devices.

ESD Machine Model (Class A): 50V

ESD Human Body Model (Class 1A): 250V

Refer to Avago Application Note A004R:

Electrostatic Discharge Damage and Control.

RoHS-Exemption



Please refer to hazardous substances table on page 10.

Table 1. AMMC-6630 Absolute Maximum Ratings^[1]

Symbol	Parameters and Test Conditions	Unit	Minimum	Maximum
V_C	Voltage to Control Attenuation	V	0	1.6
P_{in}	RF Input Power	dBm	-	17
T_{ch}	Operating Channel Temperature	°C	-	+150
T_{stg}	Storage Temperature	°C	-40	+150
T_{max}	Maximum Assembly Temperature	°C		+300 for 60s

Notes:

1. Operation in excess of any one of these conditions may result in permanent damage to this device. The absolute maximum ratings for V_C and P_{in} were determined at an ambient temperature of 25°C unless noted otherwise.

Table 2. AMMC-6630 DC Specifications^[1, 2]

Symbol	Parameters	Test Conditions	Unit	Min	Typical	Max
I_{C_ref}	V_C Control Current (Min Attenuation)	$V_C = 0\text{ V}$	nA	-	0	40
I_{C_ref}	V_C Control Current (Max Attenuation)	$V_C = 1.0\text{ V}$	μA	-	150	250

Notes:

1. Ambient operation temperature $T_A = 25^\circ\text{C}$ unless otherwise noted.
2. Data obtained from on-wafer measurements.

Table 3. AMMC-6630 RF Specifications^[1, 2]Small/Large-signal data measured on-wafer at $T_A = 25^\circ\text{C}$, $Z_0 = 50\ \Omega$

Symbol	Parameters and Test Conditions	Units	Freq. [GHz]	Minimum	Typical	Maximum
Minimum Attenuation (Reference State)	Small-signal S21 $V_C = 0\text{ V}$	dB	7		3.6	4.0
			16		2.1	2.5
			25		3.5	4.0
			34		4.0	5.0
			42		5.6	6.0
Maximum Attenuation	Small-signal S21 $V_C = 1.0\text{ V}$	dB	7	22.0	22.6	
			16	21.5	22.1	
			25	24.0	25.5	
			34	25.0	26.4	
			42	26.0	27.5	
RL_{in} and RL_{out} at Reference State	$V_C = 0\text{ V}$	dB	<40		10	
RL_{in} and RL_{out} at Maximum State	$V_C = 1.0\text{ V}$	dB	<40		10	

Typical Distribution Charts

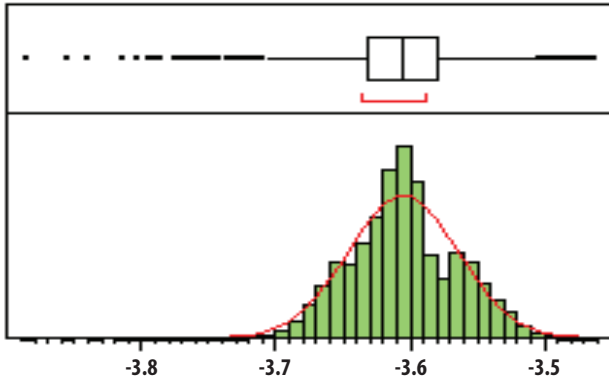

Figure 1. Min Attenuation @ 7GHz, Nominal=-3.6, LSL=-4.0

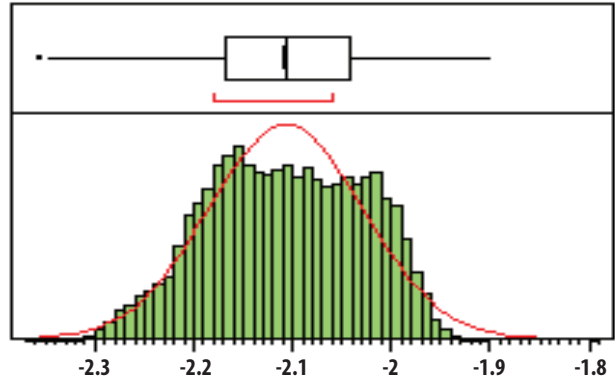

Figure 2. Min Attenuation @ 16GHz, Nominal=-2.1, LSL=-2.5

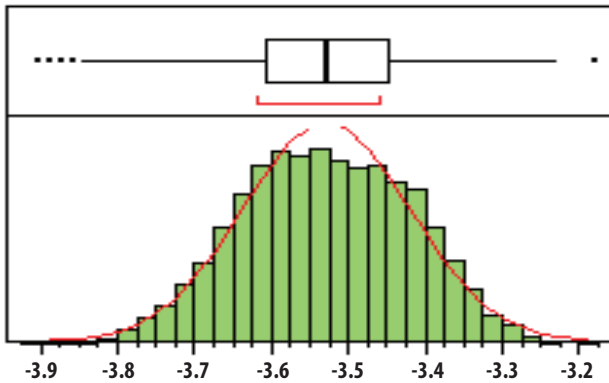

Figure 3. Min Attenuation @ 25GHz, Nominal=-3.5, LSL=-4.0

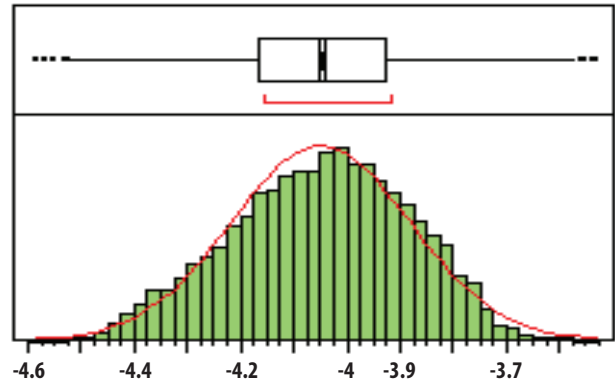

Figure 4. Min Attenuation @ 34 GHz, Nominal=-4.05, LSL=-5.0

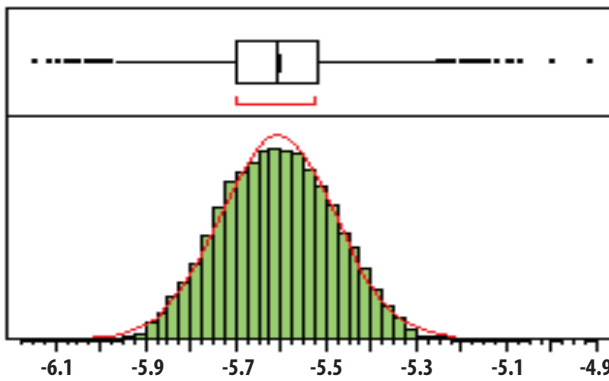

Figure 5. Min Attenuation @ 42GHz, Nominal=-5.6, LSL=-6.0

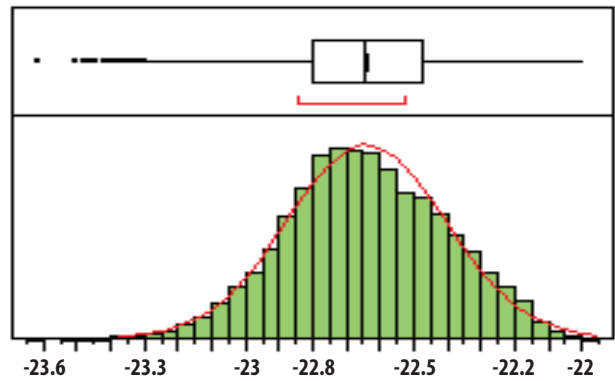

Figure 6. Max Attenuation @ 7GHz, Nominal=-22.6, USL=-22.0

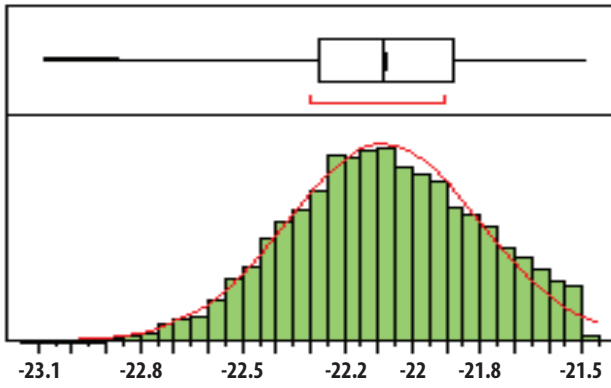

Figure 7. Max Attenuation@16GHz, Nominal=-22.0, USL=-21.5

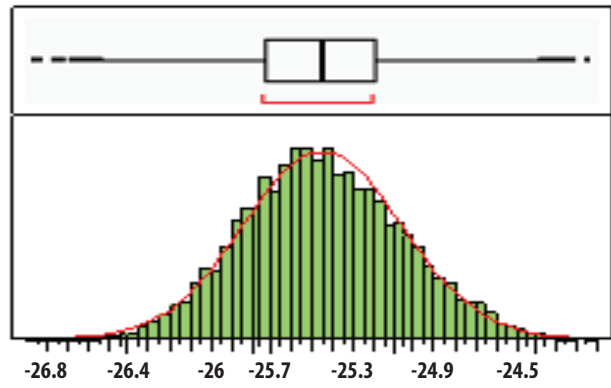

Figure 8. Max Attenuation @ 25GHz, Nominal=-24.4, USL=-24.0

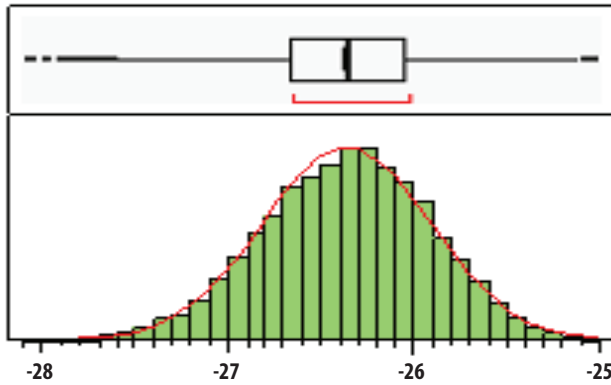

Figure 9. Max Attenuation@34GHz, Nominal=-26.3, USL=-25.0

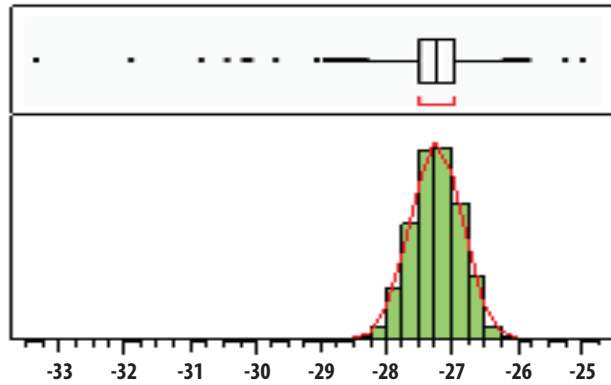

Figure 10. Max Attenuation @ 42GHz, Nominal=-27.2, USL=-26.0

Notes:

1. Attenuation is a positive number; whereas, S_{21} as measured on a Network Analyzer is a negative number.
2. Data obtained from on-wafer measurements.
3. Distribution data based on 5000 part sample size from two wafer lots during initial characterization of this product. Future wafers allocated to this product may have nominal values anywhere between upper and lower limits.

AMMC-6630 Typical Performance ($T_A = 25^\circ\text{C}$, $Z_{in} = Z_{out} = 50 \Omega$)

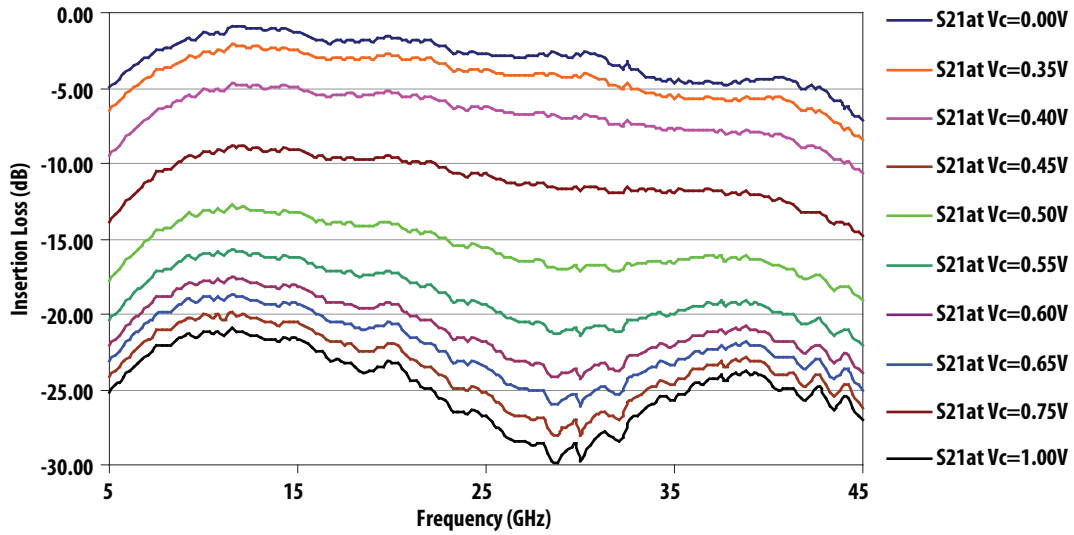

Figure 11. Insertion Loss vs Frequency

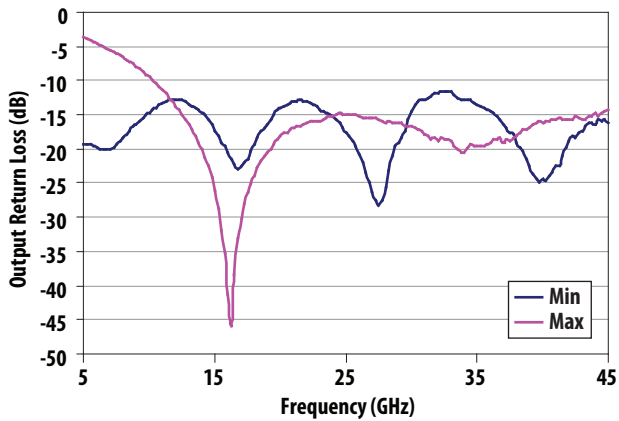

Figure 12. Output Return Loss vs Frequency

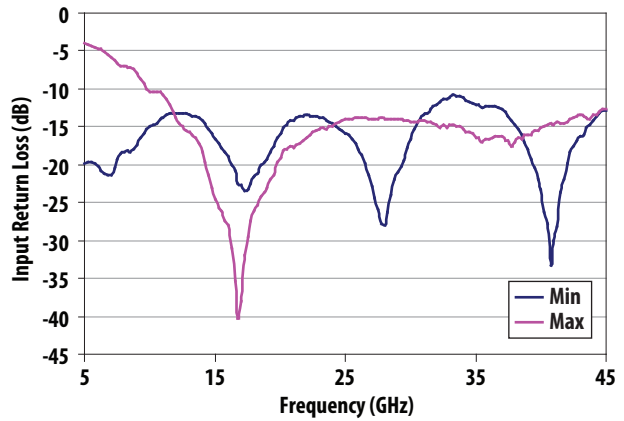

Figure 13. Input Return Loss vs Frequency at Max Attenuation

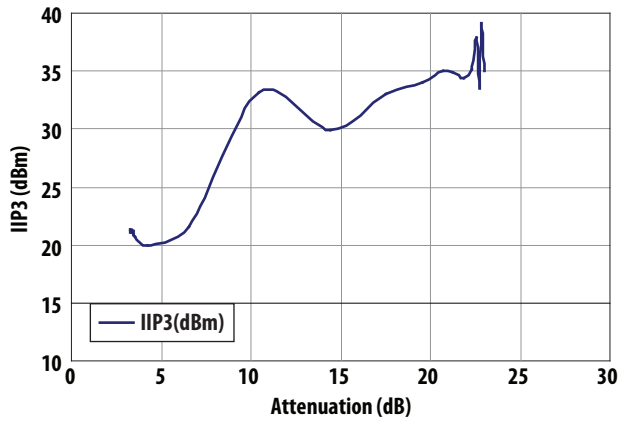

Figure 14a. IIP3 vs Attenuation (Frequency = 7 GHz, Input Power = -10dBm)

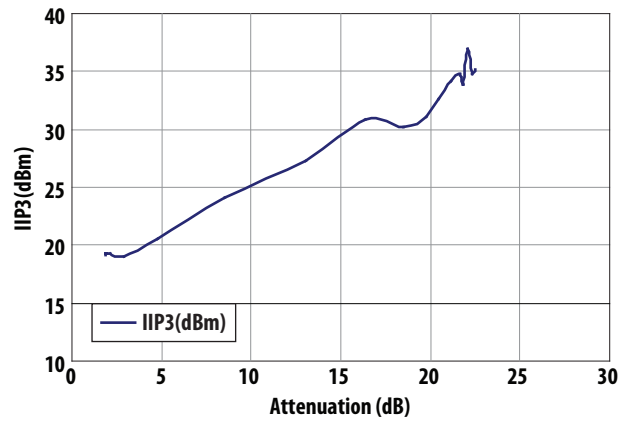

Figure 14b. IIP3 vs Attenuation (Frequency = 16 GHz, Input Power = -10dBm)

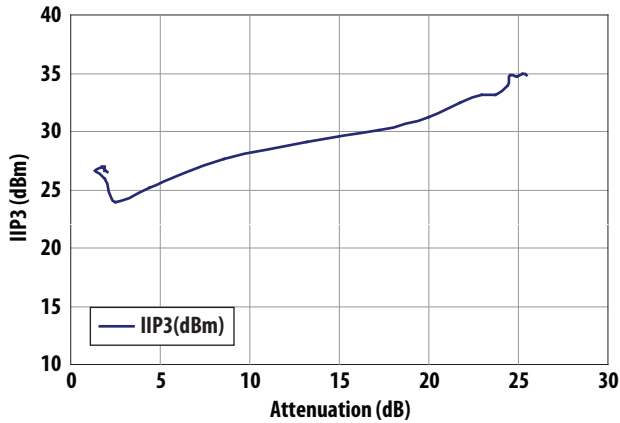

Figure 14c. IIP3 vs Attenuation (Frequency = 25 GHz, Input Power = -10dBm)

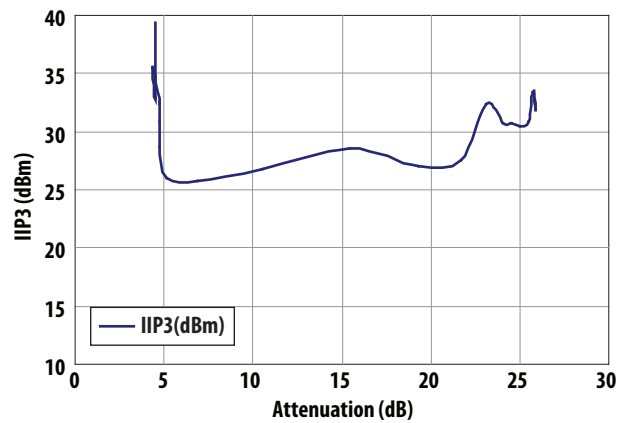

Figure 14d. IIP3 vs Attenuation (Frequency = 35 GHz, Input Power = -13dBm)

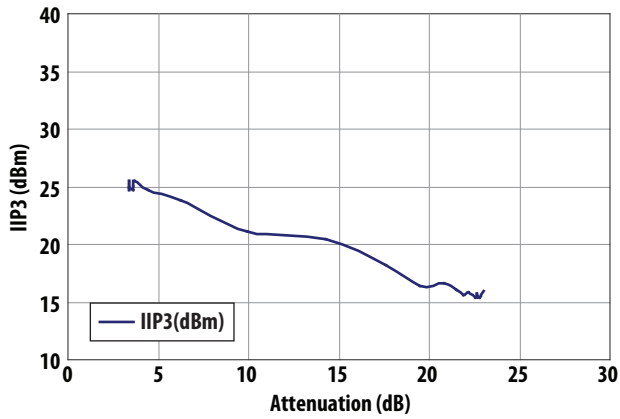

Figure 14e. IIP3 vs Attenuation (Frequency = 42 GHz, Input Power = -16dBm)

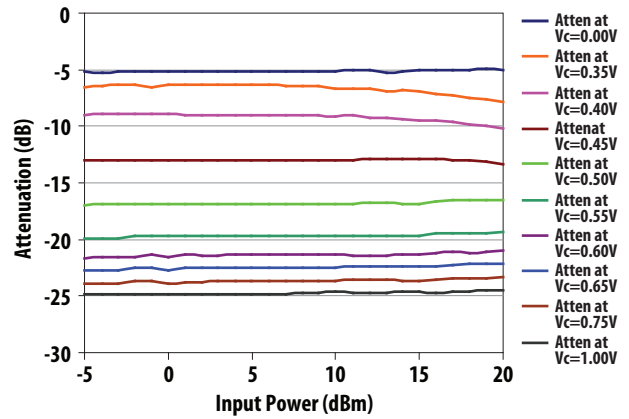

Figure 15a. Attenuation vs Input Power (Frequency = 7 GHz)

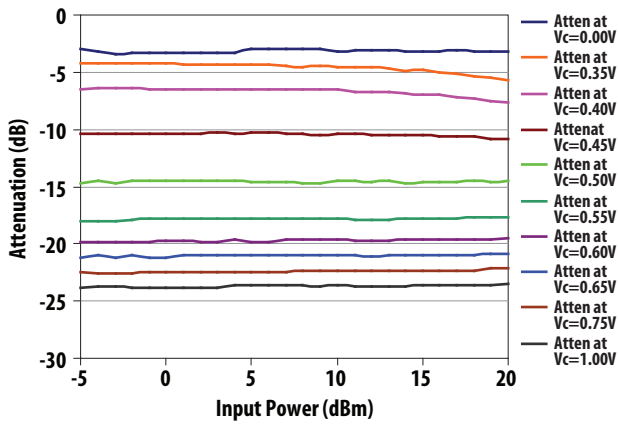

Figure 15b. Attenuation vs Input Power (Frequency = 16 GHz)

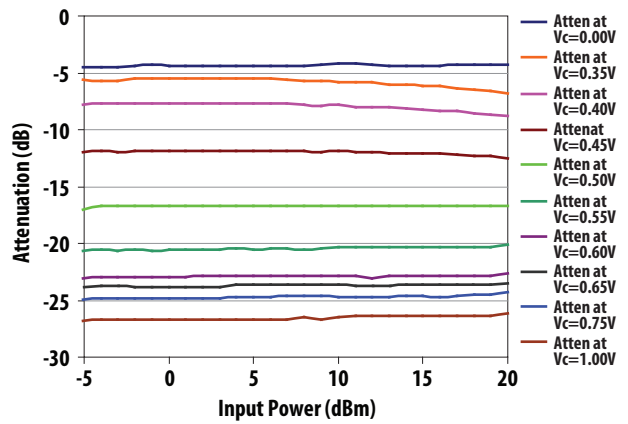

Figure 15c. Attenuation vs Input Power (Frequency = 25 GHz)

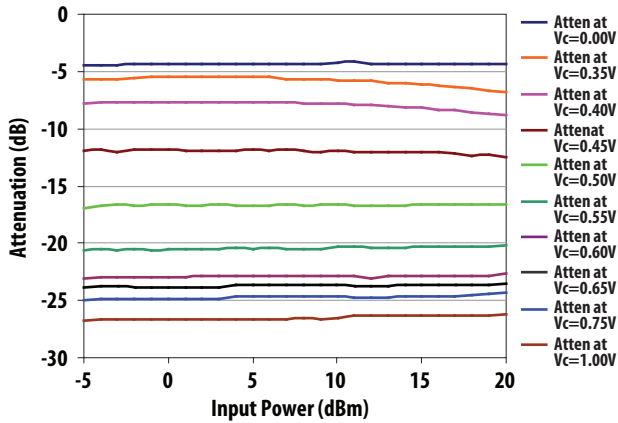

Figure 15d. Attenuation vs Input Power (Frequency = 34 GHz)

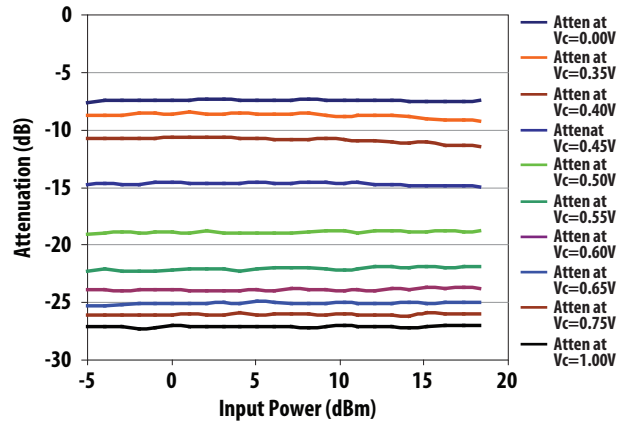

Figure 15e. Attenuation vs Input Power (Frequency = 42 GHz)

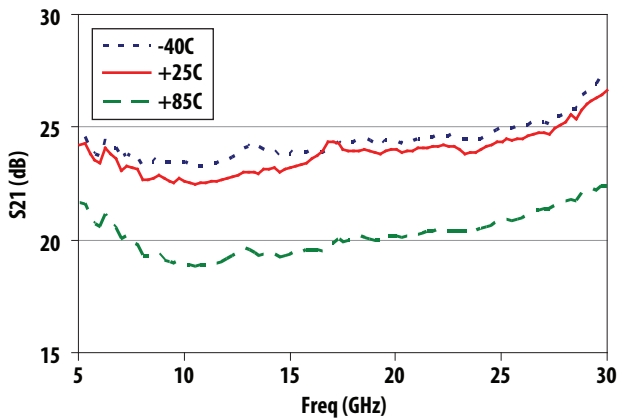

Figure 16. Attenuation vs Frequency (Max Attenuation)

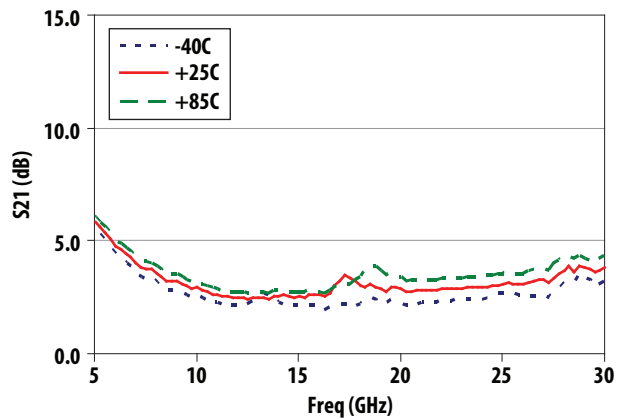

Figure 17. Attenuation vs Frequency (Min Attenuation)

Note for Figure 15a ~ 15e:

1. Attenuation is a positive number, whereas insertion loss S_{21} measured on a network analyzer is a negative number.

AMMC-6630 Typical Scattering Parameters at Min Attenuation ($T_c = 25^\circ\text{C}$, $Z_0 = 50\text{ohm}$, $V_C = 0\text{V}$)

Freq GHz	S11			S21			S12			S22		
	dB	Mag	Phase	dB	Mag	Phase	dB	Mag	Phase	dB	Mag	Phase
1	-29.1	0.0351	-100.8	-17.7	0.131	-115	-17.7	0.1306	-115.1	-29.3	0.0342	-97.1
2	-24.8	0.0577	-130.6	-11.7	0.2606	-133.4	-11.7	0.2591	-133.6	-24.4	0.0602	-135.5
3	-22.7	0.0734	-161.1	-8.2	0.3893	-157.8	-8.2	0.39	-157.5	-22.9	0.0717	-164.3
4	-20.9	0.09	178.6	-6.4	0.4785	-179.9	-6.4	0.4787	-179.9	-20.5	0.0944	176.2
5	-19.8	0.1021	156.5	-5	0.5616	160.5	-5	0.5602	160.1	-19.3	0.1088	149.3
6	-20.1	0.0984	132.5	-3.8	0.6442	140.1	-3.9	0.6404	140.4	-19.7	0.1035	129.1
7	-21.4	0.0855	131.4	-3	0.71	120.3	-3	0.7067	120.4	-20.1	0.0991	121.3
8	-18.4	0.1207	119.5	-2.4	0.7598	101.2	-2.3	0.7661	100.1	-18.5	0.1194	114.9
9	-17.5	0.1336	109	-1.8	0.8101	81.6	-2	0.79	81.3	-16.5	0.1496	102.4
10	-15	0.1785	87.9	-1.4	0.8524	61	-1.5	0.8377	63.2	-14.7	0.184	84.3
11	-13.8	0.2052	65	-1.4	0.8524	43.3	-1.2	0.8721	42.2	-13.4	0.2144	61.8
12	-13.3	0.2171	38.5	-0.9	0.8992	23.9	-1	0.8927	24.1	-12.7	0.2321	35.9
13	-13.4	0.2127	12.3	-1	0.8876	4.8	-1.1	0.8847	4.7	-13.4	0.2131	7.6
14	-14.2	0.1949	-17.6	-1.2	0.8756	-13.6	-1.1	0.8767	-14	-14.7	0.1847	-19.6
15	-16.6	0.1478	-47.7	-1.3	0.8615	-32.1	-1.4	0.8534	-31.7	-17.2	0.1387	-53.4
16	-18.8	0.1147	-80.9	-1.8	0.8098	-48.6	-1.7	0.8203	-48.7	-20.4	0.0952	-94.5
17	-22.7	0.0729	-134.8	-1.9	0.8064	-62.5	-2.1	0.7848	-62.1	-22.5	0.075	-161.7
18	-21.7	0.0827	148.9	-1.9	0.8033	-78.3	-1.8	0.816	-76.2	-19.5	0.1059	134.5
19	-19.3	0.1078	93.7	-1.9	0.8037	-93.4	-1.7	0.8179	-94.8	-16.5	0.1497	92.6
20	-16	0.159	63	-1.7	0.8215	-110.9	-1.8	0.8146	-110.2	-14	0.2002	62.2
21	-14.1	0.1961	34.9	-1.9	0.8001	-127.1	-1.6	0.8358	-128.1	-13	0.225	35.4
22	-13.5	0.2115	8.3	-1.8	0.809	-145.9	-2	0.7945	-145.8	-13	0.2245	10.4
23	-13.7	0.2056	-14.2	-2.5	0.7502	-162.8	-2.4	0.7576	-161.9	-14.2	0.1946	-10.2
24	-14.5	0.1876	-34.3	-2.8	0.7272	-175.4	-2.6	0.7387	-177.4	-15.2	0.1735	-30.1
25	-15.9	0.1605	-52.5	-2.7	0.7345	167.7	-2.8	0.7208	167.9	-17.5	0.1332	-49.2
26	-17.8	0.1287	-77.9	-2.9	0.7147	152.7	-2.9	0.7135	153.1	-20.6	0.0936	-74.7
27	-22.7	0.0732	-110.9	-3	0.7119	137.6	-3	0.7109	137.9	-26.1	0.0493	-112.5
28	-27.9	0.0402	172.4	-2.7	0.7324	121.4	-2.9	0.7184	121.4	-25.8	0.0511	142.3
29	-21	0.0889	79.2	-2.9	0.7188	103.2	-2.7	0.7307	105.8	-19.1	0.111	84.6
30	-16.7	0.1468	55.9	-2.8	0.7205	86.9	-2.4	0.7573	87.4	-14.6	0.186	63.7
31	-13.5	0.2109	25.6	-2.9	0.7179	66.3	-3	0.709	67.6	-12.8	0.2295	31.5
32	-12	0.2503	5.2	-3.5	0.6648	48	-3.4	0.6798	50.8	-11.9	0.2548	9.1
33	-11.1	0.2774	-16.1	-3.8	0.6469	33	-3.8	0.646	29.8	-11.7	0.2602	-16.2
34	-11.1	0.2774	-37.6	-4.4	0.6044	17.7	-4.4	0.6037	15.5	-12.8	0.2288	-30.5
35	-12	0.2501	-50	-4.7	0.5835	3.7	-4.6	0.5897	2.8	-13.4	0.2134	-48.7
36	-12.3	0.2432	-61.6	-4.6	0.5882	-12.3	-4.7	0.583	-13.4	-14.6	0.187	-66.9
37	-12.7	0.2321	-80.9	-4.6	0.5876	-28.1	-4.8	0.5786	-28.4	-16.3	0.1524	-90.3
38	-14.7	0.1833	-101.6	-4.7	0.5818	-42.8	-4.8	0.573	-43.2	-19	0.1118	-115.8
39	-17.9	0.1279	-122.8	-4.5	0.5962	-60.3	-4.8	0.5781	-59.3	-22.4	0.0756	-155.1
40	-23.2	0.0689	-152.9	-4.4	0.6043	-77.5	-4.4	0.6026	-76.7	-24.4	0.06	151.9
41	-30.2	0.0309	97	-4.4	0.601	-97.3	-4.4	0.5996	-96.5	-22.4	0.0758	88.3
42	-19.8	0.1019	28.8	-5	0.5611	-114.2	-4.8	0.577	-114.3	-18.8	0.1154	49.6
43	-16.3	0.1525	-9.1	-5.2	0.5509	-136	-5.3	0.5422	-137.1	-17.4	0.1348	14.9
44	-14.1	0.1972	-27.8	-6.4	0.4804	-153.8	-6.3	0.4834	-154.3	-16.5	0.1493	-22.2
45	-12.9	0.2263	-51.7	-7.2	0.4384	-172.2	-7.4	0.4269	-172.3	-16.1	0.1559	-58.4
46	-12.7	0.2316	-69	-8.6	0.3719	173.1	-8.8	0.3615	172.4	-17	0.142	-90.8
47	-11.8	0.2576	-92.1	-9.3	0.3429	158.7	-9.7	0.3266	159	-16.3	0.1527	-121.6
48	-11.8	0.2564	-117.2	-10.9	0.2845	144.4	-11.2	0.2746	146.5	-15.1	0.1751	-146.6
49	-12.8	0.2296	-139	-12.2	0.2465	129.1	-12.3	0.2439	130.2	-13.8	0.205	179.5
50	-13.1	0.2224	-158.1	-14.1	0.1969	121.1	-14.4	0.191	124.5	-12.6	0.2337	158

Note : S-parameters are obtained from on-wafer measurements.

AMMC-6630 Typical Scattering Parameters^[1] at Max Attenuation (Tc = 25°C, Zo = 50ohm, Vc = 1.0V)

Freq GHz	S11			S21			S12			S22		
	dB	Mag	Phase	dB	Mag	Phase	dB	Mag	Phase	dB	Mag	Phase
1	-2	0.8189	160.3	-37.9	0.0128	-116.2	-37.8	0.0129	-116.3	-1.7	0.8207	159.6
2	-2	0.7882	140.5	-32.2	0.0245	-137.2	-32.2	0.0246	-137.2	-2.0	0.7931	139.7
3	-3	0.7478	122.3	-28.4	0.0381	-158.9	-28.4	0.0378	-158.9	-2.4	0.7542	120.2
4	-3	0.7005	103.2	-26.5	0.0471	176.1	-26.4	0.0477	176.0	-3.0	0.7079	101.2
5	-4	0.6384	84.9	-25.2	0.0550	155.3	-25.2	0.0549	154.4	-3.7	0.6529	82.7
6	-5	0.5881	68.5	-23.8	0.0644	134.3	-23.9	0.0638	134.4	-4.5	0.5949	64.7
7	-6	0.5165	49.0	-22.8	0.0726	112.5	-22.8	0.0722	112.4	-5.5	0.5326	47.1
8	-7	0.4445	35.7	-22.1	0.0788	90.3	-22.0	0.0795	88.7	-6.6	0.4688	29.9
9	-8	0.4078	16.0	-21.4	0.0847	67.9	-21.8	0.0817	67.2	-7.9	0.4028	13.3
10	-10	0.3069	4.6	-21.2	0.0874	44.6	-21.4	0.0853	46.8	-9.5	0.3359	-2.7
11	-11	0.2930	-11.4	-21.4	0.0853	23.9	-21.2	0.0870	22.9	-11.3	0.2714	-18.3
12	-14	0.2065	-28.8	-21.1	0.0877	3.5	-21.3	0.0862	3.7	-13.6	0.2098	-32.7
13	-16	0.1650	-35.8	-21.5	0.0843	-16.4	-21.5	0.0839	-16.1	-16.3	0.1526	-46.2
14	-18	0.1236	-55.8	-21.8	0.0808	-34.4	-21.8	0.0812	-34.7	-20.0	0.1003	-59.3
15	-24	0.0599	-61.2	-21.6	0.0828	-54.4	-21.7	0.0827	-53.5	-25.9	0.0509	-72.8
16	-28	0.0399	-59.6	-22.4	0.0759	-73.7	-22.3	0.0768	-74.5	-40.3	0.0097	-59.4
17	-38	0.0122	50.0	-23.1	0.0704	-89.1	-23.2	0.0692	-88.4	-30.5	0.0298	76.1
18	-26	0.0484	61.4	-23.5	0.0666	-105.0	-23.4	0.0678	-103.9	-24.0	0.0630	69.5
19	-23	0.0695	53.6	-23.8	0.0649	-117.7	-23.7	0.0654	-118.8	-20.6	0.0932	57.9
20	-19	0.1108	49.2	-23.2	0.0691	-136.9	-23.3	0.0684	-136.4	-18.1	0.1245	48.5
21	-18	0.1290	34.8	-24.3	0.0608	-158.5	-24.1	0.0627	-158.7	-17.0	0.1416	36.7
22	-16	0.1499	27.7	-24.9	0.0568	-176.1	-25.1	0.0558	-176.1	-16.2	0.1550	27.0
23	-15	0.1709	16.8	-26.1	0.0496	165.9	-26.1	0.0495	167.2	-15.8	0.1614	19.1
24	-15	0.1802	10.5	-26.6	0.0467	152.9	-26.2	0.0490	152.4	-15.1	0.1751	11.0
25	-14	0.1980	-0.3	-26.8	0.0457	130.5	-27.0	0.0448	130.2	-14.9	0.1798	0.1
26	-14	0.2059	-10.0	-28.0	0.0398	110.4	-27.9	0.0404	111.8	-15.3	0.1725	-8.8
27	-14	0.1982	-17.9	-28.4	0.0378	94.9	-28.4	0.0380	93.5	-15.4	0.1700	-16.1
28	-14	0.2016	-24.5	-28.6	0.0373	72.2	-28.7	0.0368	73.1	-16.1	0.1572	-20.7
29	-14	0.1981	-30.8	-29.3	0.0341	60.1	-29.1	0.0350	60.2	-16.1	0.1568	-27.1
30	-14	0.1926	-37.1	-29.6	0.0329	37.4	-29.5	0.0334	36.1	-16.7	0.1457	-33.4
31	-14	0.1952	-41.1	-28.0	0.0396	25.1	-28.0	0.0396	25.9	-17.8	0.1295	-38.9
32	-15	0.1822	-47.3	-28.4	0.0381	6.6	-28.3	0.0386	7.2	-18.8	0.1149	-38.3
33	-15	0.1814	-52.2	-26.7	0.0461	-7.3	-26.7	0.0463	-9.2	-18.8	0.1144	-42.0
34	-15	0.1729	-59.4	-25.9	0.0507	-24.2	-26.0	0.0500	-25.5	-20.4	0.0950	-34.5
35	-16	0.1516	-61.1	-25.7	0.0518	-42.1	-25.7	0.0516	-41.8	-19.6	0.1045	-37.6
36	-17	0.1481	-56.5	-24.7	0.0583	-56.9	-24.7	0.0580	-56.5	-19.2	0.1097	-35.8
37	-16	0.1523	-61.2	-24.3	0.0607	-73.6	-24.6	0.0590	-73.5	-19.0	0.1117	-41.8
38	-17	0.1397	-57.4	-24.0	0.0630	-86.8	-24.3	0.0608	-89.4	-18.0	0.1253	-40.5
39	-16	0.1586	-58.0	-24.0	0.0632	-105.3	-24.0	0.0628	-104.7	-17.0	0.1411	-51.5
40	-15	0.1762	-62.4	-24.4	0.0606	-121.4	-24.6	0.0589	-121.1	-16.3	0.1537	-67.0
41	-15	0.1826	-70.0	-24.9	0.0566	-129.8	-25.1	0.0558	-129.6	-15.7	0.1639	-82.2
42	-14	0.1905	-73.7	-25.7	0.0518	-138.9	-25.8	0.0515	-139.5	-15.6	0.1650	-98.3
43	-13	0.2136	-84.7	-25.6	0.0526	-156.4	-25.8	0.0512	-156.7	-15.7	0.1644	-116.9
44	-13	0.2142	-91.9	-25.4	0.0536	-161.0	-25.6	0.0526	-161.2	-14.7	0.1849	-134.1
45	-13	0.2332	-104.1	-27.1	0.0443	-176.7	-27.6	0.0416	-177.7	-14.2	0.1947	-149.9
46	-13	0.2348	-114.7	-28.8	0.0365	174.7	-28.9	0.0361	176.1	-13.5	0.2121	-167.6
47	-11	0.2817	-129.0	-27.3	0.0434	168.6	-27.7	0.0414	170.7	-12.5	0.2376	176.6
48	-10	0.3097	-150.2	-30.9	0.0286	164.3	-31.0	0.0282	169.7	-11.5	0.2658	164.7
49	-10	0.3122	-168.8	-30.5	0.0300	140.7	-30.5	0.0299	142.4	-9.7	0.3264	145.8
50	-10	0.3202	174.1	-29.2	0.0346	141.1	-29.9	0.0320	149.2	-8.8	0.3650	130.4

Note : S-parameters are obtained from on-wafer measurements.

AMMC-6630 Bias and Usage

The recommended DC control voltage range is $V_c=0$ to 1 volt. Simplified schematic for the MMIC die is shown in Figure 18.

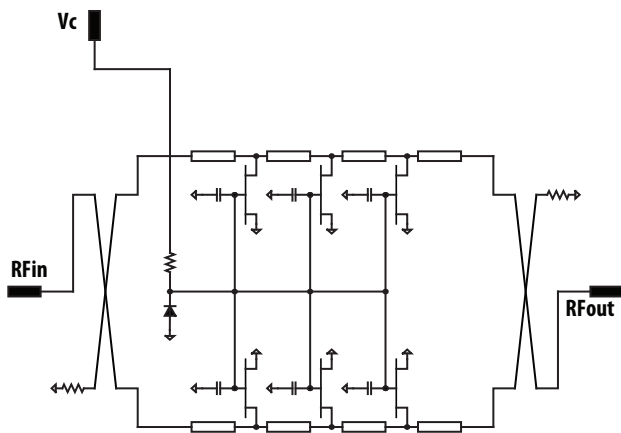

Figure 18. AMMC-6630 simplified schematic

AMMC-6630 Assembly Techniques

The backside of the MMIC chip is RF ground. For microstrip applications the chip should be attached directly to the ground plane (e.g. circuit carrier or heatsink) using electrically conductive epoxy [1].

For best performance, the topside of the MMIC should be brought up to the same height as the circuit surrounding it. This can be accomplished by mounting a gold plated metal shim (same length as the MMIC) under the chip which is of correct thickness to make the chip and adjacent circuit the same height. The amount of epoxy used for the chip or shim attachment should be just enough to provide a thin fillet around the bottom perimeter of the chip. The ground plane should be free of any residue that may jeopardize electrical or mechanical attachment.

RF connections should be kept as short as reasonable to minimize performance degradation due to undesirable series inductance. A single bond wire is normally sufficient for signal connections, however double bonding with 0.7mil gold wire will reduce series inductance. Gold thermo-sonic wedge bonding is the preferred method for wire attachment to the bond pads. The recommended wire bond stage temperature is $150^{\circ}\text{C} \pm 2^{\circ}\text{C}$. Caution should be taken to not exceed the Absolute Maximum Rating for assembly temperature and time.

The chip is 100um thick and should be handled with care. Even though this MMIC has 4550 Angstroms of silicon nitride covering the air bridges on the top surface of the die, it should be handled by the edges or with a custom collet (do not pick up the die with a vacuum on die center). Bonding pads and chip backside metallization are gold. For further assembly information please see Avago application note# 5409.

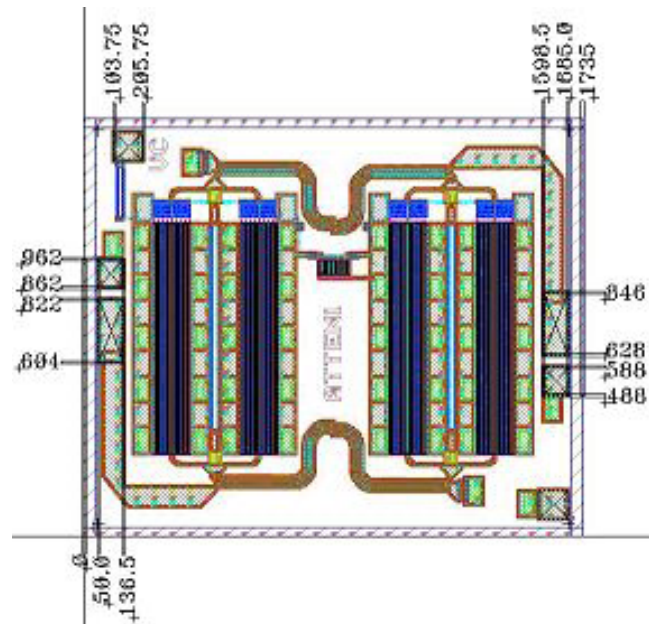

Figure 19. AMMC-6630 Bond Pad Locations

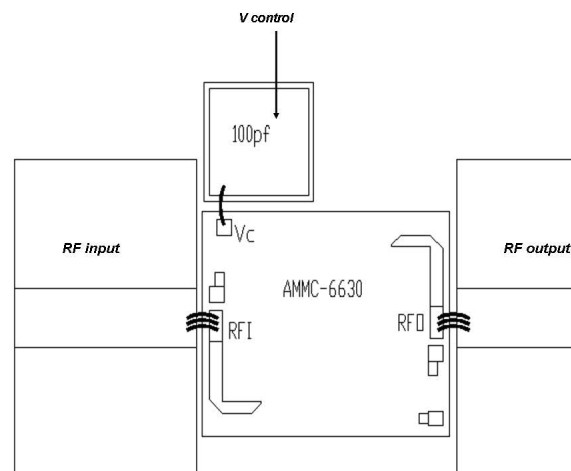

Figure 20. Assembly Bond Diagram

This MMIC is static sensitive and ESD precautions should be taken.

50V Machine Model
250V Human Body Model
Class 0A

Notes:

1. Ablebond 84-1 LMI silver epoxy is recommended.

Ordering Information:

AMMC-6630-W10 = 10 devices per tray
AMMC-6630-W50 = 50 devices per tray



Names and Contents of the Toxic and Hazardous Substances or Elements in the Products
 产品中有毒有害物质或元素的名称及含量

Part Name 部件名称	Toxic and Hazardous Substances or Elements 有毒有害物质或元素					
	Lead (Pb) 铅 (Pb)	Mercury (Hg) 汞 (Hg)	Cadmium (Cd) 镉 (Cd)	Hexavalent (Cr(VI)) 六价铬 (Cr(VI))	Polybrominated biphenyl (PBB) 多溴联苯 (PBB)	Polybrominated diphenylether (PBDE) 多溴二苯醚 (PBDE)
100pF capacitor	x	o	o	o	o	o

o: indicates that the content of the toxic and hazardous substance in all the homogeneous materials of the part is below the concentration limit requirement as described in SJ/T 11363-2006.
 x: indicates that the content of the toxic and hazardous substance in at least one homogeneous material of the part exceeds the concentration limit requirement as described in SJ/T 11363-2006.
 (The enterprise may further explain the technical reasons for the "x" indicated portion in the table in accordance with the actual situations.)

o: 表示该有毒有害物质在该部件所有均质材料中的含量均在 SJ/T 11363-2006 标准规定的限量要求以下。
 x: 表示该有毒有害物质至少在该部件的某一均质材料中的含量超出 SJ/T 11363-2006 标准规定的限量要求。
 (企业可在此处, 根据实际情况对上表中打"x"的技术原因进行进一步说明。)

Note: EU RoHS compliant under exemption clause of "lead in electronic ceramic parts (e.g. piezoelectronic devices)"

For product information and a complete list of distributors, please go to our web site: www.avagotech.com

Avago, Avago Technologies, and the A logo are trademarks of Avago Technologies in the United States and other countries.
 Data subject to change. Copyright © 2005-2009 Avago Technologies. All rights reserved.
 AV02-1754EN - August 12, 2009

