

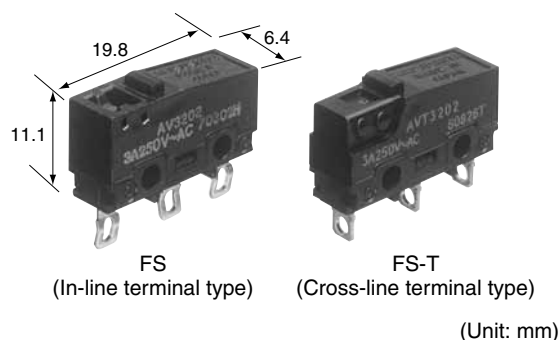

### Subminiature Size Switches with Excellent Operating Position Accuracy

### AV3/AVM3/AVT3/AVL3 (FS/FS-T) Switches



RoHS compliant

### FEATURES

- Excellent operating position accuracy
- Flux-resistant construction with integrally molded terminals
- Added to former in-line terminal (AV3/AVM3), range now includes (AVT3/AVL3) type with cross-line terminals
- Self-standing terminal structure (AV3/AVM3 type) with temporarily fix switch to PC Board
- Lever pivot position can be changed
- Series of low-level circuit type switches added to range
- Protection grade: IP40

### PRODUCT TYPES TABLE

#### ■ Combination of Operating Force (OF) and Applicable current range

Expected life	Contact	Applicable current range				Operating Force (OF)			
		1mA	100mA	3A	5A	0.25N	0.49N	0.98N	1.47N
Standard version	AgNi alloy contact			●			●	●	
	CuNi alloy + AgNi alloy + Au-clad triple layer contact type (End of part No.: 61)	●				●	●	●	
	CuNi alloy + Au-clad double layer contact For low-level circuit (End of part No.: 64)	●				●	●	●	
Long life version	AgNi alloy contact			●					●
	CuNi alloy + AgNi alloy + Au-clad triple layer contact type (End of part No.: 61)	●							●
	CuNi alloy + Au-clad double layer contact For low-level circuit (End of part No.: 64)	●							●

Note: For high capacity contact rating up to 10.1 A, please refer to PS (AVM3□□□P) switches catalog.

### CONSTRUCTION

#### ■ Standard version (FS type)

- As for FS-T switches, the terminals are the different shape.

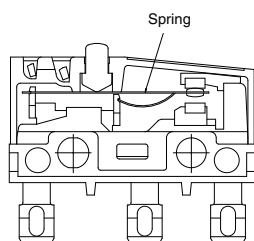

#### ■ Long life version (FS type)

- As for FS-T switches, the terminals are the different shape.

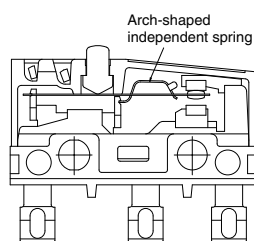

### CONTACT FORM

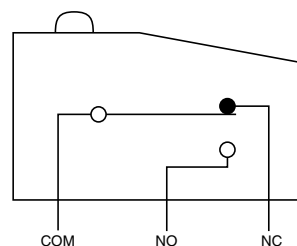

## ORDERING INFORMATION

### ■ FS switches (In-line terminal type)

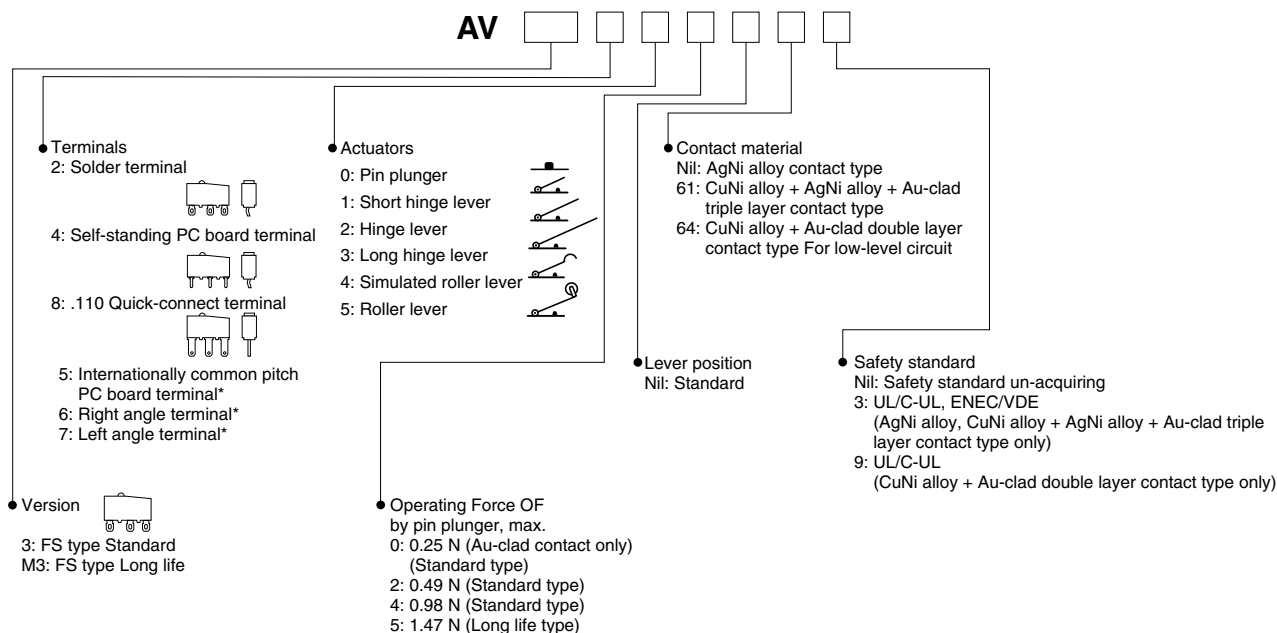

### ■ FS-T switches (Cross-line terminal type)

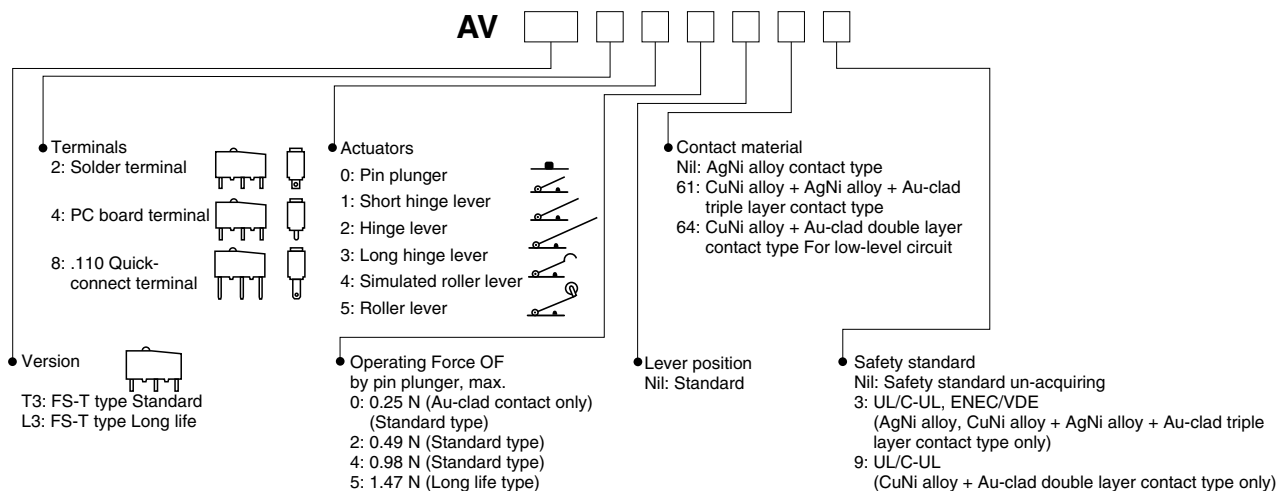

Note: Since the switches of terminal of an asterisk "\*" will be manufactured after an order receipt, please contact our office.

**PRODUCT TYPES**

(Color of plunger) AgNi alloy contact type: black, CuNi alloy + AgNi alloy + Au-clad triple layer contact type: red, CuNi alloy + Au-clad contact type: green

■ **FS type, Standard version (In-line terminal type)**

1) AgNi alloy contact type

Actuator	Operating Force OF, Max.	Part No.		
		Solder terminal	Self-standing PC board terminal	.110 Quick-connect
Pin plunger	0.49N	AV32023	AV34023	AV38023
	0.98N	AV32043	AV34043	AV38043
Short hinge lever	0.20N	AV32123	AV34123	AV38123
	0.39N	AV32143	AV34143	AV38143
Hinge lever	0.16N	AV32223	AV34223	AV38223
	0.34N	AV32243	AV34243	AV38243
Long hinge lever	0.12N	AV32323	AV34323	AV38323
	0.25N	AV32343	AV34343	AV38343
Simulated roller lever	0.16N	AV32423	AV34423	AV38423
	0.34N	AV32443	AV34443	AV38443
Roller lever	0.20N	AV32523	AV34523	AV38523
	0.39N	AV32543	AV34543	AV38543

2) CuNi alloy + AgNi alloy + Au-clad triple layer contact type

Actuator	Operating Force OF, Max.	Part No.		
		Solder terminal	Self-standing PC board terminal	.110 Quick-connect
Pin plunger	0.25N	AV3200613	AV3400613	AV3800613
	0.49N	AV3202613	AV3402613	AV3802613
	0.98N	AV3204613	AV3404613	AV3804613
Short hinge lever	0.098N	AV3210613	AV3410613	AV3810613
	0.20N	AV3212613	AV3412613	AV3812613
	0.39N	AV3214613	AV3414613	AV3814613
Hinge lever	0.078N	AV3220613	AV3420613	AV3820613
	0.16N	AV3222613	AV3422613	AV3822613
	0.34N	AV3224613	AV3424613	AV3824613
Long hinge lever	0.12N	AV3232613	AV3432613	AV3832613
	0.25N	AV3234613	AV3434613	AV3834613
Simulated roller lever	0.16N	AV3242613	AV3442613	AV3842613
	0.34N	AV3244613	AV3444613	AV3844613
Roller lever	0.20N	AV3252613	AV3452613	AV3852613
	0.39N	AV3254613	AV3454613	AV3854613

3) CuNi alloy + Au-clad contact type, for low-level circuit

Actuator	Operating Force OF, Max.	Part No.		
		Solder terminal	Self-standing PC board terminal	.110 Quick-connect
Pin plunger	0.25N	AV3200649	AV3400649	AV3800649
	0.49N	AV3202649	AV3402649	AV3802649
	0.98N	AV3204649	AV3404649	AV3804649
Short hinge lever	0.098N	AV3210649	AV3410649	AV3810649
	0.20N	AV3212649	AV3412649	AV3812649
	0.39N	AV3214649	AV3414649	AV3814649
Hinge lever	0.078N	AV3220649	AV3420649	AV3820649
	0.16N	AV3222649	AV3422649	AV3822649
	0.34N	AV3224649	AV3424649	AV3824649
Long hinge lever	0.12N	AV3232649	AV3432649	AV3832649
	0.25N	AV3234649	AV3434649	AV3834649
Simulated roller lever	0.16N	AV3242649	AV3442649	AV3842649
	0.34N	AV3244649	AV3444649	AV3844649
Roller lever	0.20N	AV3252649	AV3452649	AV3852649
	0.39N	AV3254649	AV3454649	AV3854649

Note: Other types of terminals are also available. When ordering, please refer to "ORDERING INFORMATION".

# AV3/AVM3/AVT3/AVL3 (FS/FS-T) Subminiature Switches

## ■ FS-T type Standard version (Cross-line terminal type)

### 1) AgNi alloy contact type

Actuator	Operating Force OF, Max.	Part No.		
		Solder terminal	PC board terminal	.110 Quick-connect
Pin plunger	0.49N	AVT32023	AVT34023	AVT38023
	0.98N	AVT32043	AVT34043	AVT38043
Short hinge lever	0.20N	AVT32123	AVT34123	AVT38123
	0.39N	AVT32143	AVT34143	AVT38143
Hinge lever	0.16N	AVT32223	AVT34223	AVT38223
	0.34N	AVT32243	AVT34243	AVT38243
Long hinge lever	0.12N	AVT32323	AVT34323	AVT38323
	0.25N	AVT32343	AVT34343	AVT38343
Simulated roller lever	0.16N	AVT32423	AVT34423	AVT38423
	0.34N	AVT32443	AVT34443	AVT38443
Roller lever	0.20N	AVT32523	AVT34523	AVT38523
	0.39N	AVT32543	AVT34543	AVT38543

### 2) CuNi alloy + AgNi alloy + Au-clad triple layer contact type

Actuator	Operating Force OF, Max.	Part No.		
		Solder terminal	PC board terminal	.110 Quick-connect
Pin plunger	0.25N	AVT3200613	AVT3400613	AVT3800613
	0.49N	AVT3202613	AVT3402613	AVT3802613
	0.98N	AVT3204613	AVT3404613	AVT3804613
Short hinge lever	0.098N	AVT3210613	AVT3410613	AVT3810613
	0.20N	AVT3212613	AVT3412613	AVT3812613
	0.39N	AVT3214613	AVT3414613	AVT3814613
Hinge lever	0.078N	AVT3220613	AVT3420613	AVT3820613
	0.16N	AVT3222613	AVT3422613	AVT3822613
	0.34N	AVT3224613	AVT3424613	AVT3824613
Long hinge lever	0.12N	AVT3232613	AVT3432613	AVT3832613
	0.25N	AVT3234613	AVT3434613	AVT3834613
Simulated roller lever	0.16N	AVT3242613	AVT3442613	AVT3842613
	0.34N	AVT3244613	AVT3444613	AVT3844613
Roller lever	0.20N	AVT3252613	AVT3452613	AVT3852613
	0.39N	AVT3254613	AVT3454613	AVT3854613

### 3) CuNi alloy + Au-clad double layer contact type, for low-level circuit

Actuator	Operating Force OF, Max.	Part No.		
		Solder terminal	PC board terminal	.110 Quick-connect
Pin plunger	0.25N	AVT3200649	AVT3400649	AVT3800649
	0.49N	AVT3202649	AVT3402649	AVT3802649
	0.98N	AVT3204649	AVT3404649	AVT3804649
Short hinge lever	0.098N	AVT3210649	AVT3410649	AVT3810649
	0.20N	AVT3212649	AVT3412649	AVT3812649
	0.39N	AVT3214649	AVT3414649	AVT3814649
Hinge lever	0.078N	AVT3220649	AVT3420649	AVT3820649
	0.16N	AVT3222649	AVT3422649	AVT3822649
	0.34N	AVT3224649	AVT3424649	AVT3824649
Long hinge lever	0.12N	AVT3232649	AVT3432649	AVT3832649
	0.25N	AVT3234649	AVT3434649	AVT3834649
Simulated roller lever	0.16N	AVT3242649	AVT3442649	AVT3842649
	0.34N	AVT3244649	AVT3444649	AVT3844649
Roller lever	0.20N	AVT3252649	AVT3452649	AVT3852649
	0.39N	AVT3254649	AVT3454649	AVT3854649

**■ FS type, Long life version (In-line terminal type)**

1) AgNi alloy contact type

Actuator	Operating Force OF, Max.	Part No.		
		Solder terminal	Self-standing PC board terminal	.110 Quick-connect
Pin plunger	1.47N	AVM32053	AVM34053	AVM38053
Short hinge lever	0.59N	AVM32153	AVM34153	AVM38153
Hinge lever	0.54N	AVM32253	AVM34253	AVM38253
Long hinge lever	0.44N	AVM32353	AVM34353	AVM38353
Simulated roller lever	0.54N	AVM32453	AVM34453	AVM38453
Roller lever	0.59N	AVM32553	AVM34553	AVM38553

2) CuNi alloy + AgNi alloy + Au-clad triple layer contact type

Actuator	Operating Force OF, Max.	Part No.		
		Solder terminal	Self-standing PC board terminal	.110 Quick-connect
Pin plunger	1.47N	AVM3205613	AVM3405613	AVM3805613
Short hinge lever	0.59N	AVM3215613	AVM3415613	AVM3815613
Hinge lever	0.54N	AVM3225613	AVM3425613	AVM3825613
Long hinge lever	0.44N	AVM3235613	AVM3435613	AVM3835613
Simulated roller lever	0.54N	AVM3245613	AVM3445613	AVM3845613
Roller lever	0.59N	AVM3255613	AVM3455613	AVM3855613

3) CuNi alloy + Au-clad double layer contact type, for low-level circuit

Actuator	Operating Force OF, Max.	Part No.		
		Solder terminal	Self-standing PC board terminal	.110 Quick-connect
Pin plunger	1.47N	AVM3205649	AVM3405649	AVM3805649
Short hinge lever	0.59N	AVM3215649	AVM3415649	AVM3815649
Hinge lever	0.54N	AVM3225649	AVM3425649	AVM3825649
Long hinge lever	0.44N	AVM3235649	AVM3435649	AVM3835649
Simulated roller lever	0.54N	AVM3245649	AVM3445649	AVM3845649
Roller lever	0.59N	AVM3255649	AVM3455649	AVM3855649

Note: Other types of terminals are also available. When ordering, please refer to "ORDERING INFORMATION".

**■ FS-T Long life version (Cross-line terminal type)**

1) AgNi alloy contact type

Actuator	Operating Force OF, Max.	Part No.		
		Solder terminal	PC board terminal	.110 Quick-connect
Pin plunger	1.47N	AVL32053	AVL34053	AVL38053
Short hinge lever	0.59N	AVL32153	AVL34153	AVL38153
Hinge lever	0.54N	AVL32253	AVL34253	AVL38253
Long hinge lever	0.44N	AVL32353	AVL34353	AVL38353
Simulated roller lever	0.54N	AVL32453	AVL34453	AVL38453
Roller lever	0.59N	AVL32553	AVL34553	AVL38553

2) CuNi alloy + AgNi alloy + Au-clad triple layer contact type

Actuator	Operating Force OF, Max.	Part No.		
		Solder terminal	PC board terminal	.110 Quick-connect
Pin plunger	1.47N	AVL3205613	AVL3405613	AVL3805613
Short hinge lever	0.59N	AVL3215613	AVL3415613	AVL3815613
Hinge lever	0.54N	AVL3225613	AVL3425613	AVL3825613
Long hinge lever	0.44N	AVL3235613	AVL3435613	AVL3835613
Simulated roller lever	0.54N	AVL3245613	AVL3445613	AVL3845613
Roller lever	0.59N	AVL3255613	AVL3455613	AVL3855613

3) CuNi alloy + Au-clad double layer contact type, for low-level circuit

Actuator	Operating Force OF, Max.	Part No.		
		Solder terminal	PC board terminal	.110 Quick-connect
Pin plunger	1.47N	AVL3205649	AVL3405649	AVL3805649
Short hinge lever	0.59N	AVL3215649	AVL3415649	AVL3815649
Hinge lever	0.54N	AVL3225649	AVL3425649	AVL3825649
Long hinge lever	0.44N	AVL3235649	AVL3435649	AVL3835649
Simulated roller lever	0.54N	AVL3245649	AVL3445649	AVL3845649
Roller lever	0.59N	AVL3255649	AVL3455649	AVL3855649

## SPECIFICATIONS

(Common for FS type and FS-T type)

### ■ Contact rating

Type	Standard version				Long life version			
Contact specification	AgNi alloy contact type Plunger color: Black		Au-clad contact type		AgNi alloy contact type Plunger color: Black		Au-clad contact type	
			Triple layer contact type Plunger color: Red	Double layer contact type For low-level circuit Plunger color: Green			Triple layer contact type Plunger color: Red	Double layer contact type For low-level circuit Plunger color: Green
Load style Contact voltage	Resistive load ( $\cos\phi \approx 1$ )	Inductive load ( $\cos\phi \approx 0.6$ to $0.7$ )	Resistive load ( $\cos\phi \approx 1$ )	Inductive load ( $\cos\phi \approx 1$ )	Resistive load ( $\cos\phi \approx 1$ )	Inductive load ( $\cos\phi \approx 0.6$ to $0.7$ )	Resistive load ( $\cos\phi \approx 1$ )	Inductive load ( $\cos\phi \approx 1$ )
125V AC	3A	2A	0.1A	—	5A	3A	0.1A	—
250V AC	3A	2A	0.1A	—	5A	3A	0.1A	—
30V DC	3A	2A	0.1A	0.1A	5A	3A	0.1A	0.1A
125V DC	0.4A	0.05A	—	—	0.4A	0.05A	—	—

Note: Time constant shall be less than 7 msec. for DC inductive loads.

### • Low-level circuit rating (Au-clad contact type)

Rated voltage	Resistive load
6 V DC	5 mA
12 V DC	2 mA
24 V DC	1 mA

### • Contact material reference chart classified by load voltage & current

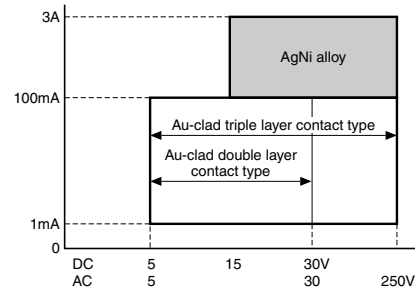

Note: If the contact is being used in the constant low-level circuit load range, the Au-clad double layer contact type is recommended. If there is a danger of the current being less than 0.5 A, for instance if the contact is being turned on and off, the Au-clad triple layer contact type is recommended. The diagram above is intended as a reference. Please use the product within the rated voltage and current.

### ■ Characteristics

Item		Standard version		Long life version		Test condition
		AgNi alloy contact type	Au-clad contact type	AgNi alloy contact type	Au-clad contact type	
Expected life	Mechanical life	Min. $5 \times 10^5$ (OTmax.)		Min. $3 \times 10^7$ (OT: Specified value) Min. $10^7$ (OTmax.)		at 60 cpm
	Electrical life	Min. $5 \times 10^4$	Min. $2 \times 10^5$	$5 \times 10^4$	$2 \times 10^5$	at 20 cpm, at rated load, OT max.
Insulation resistance		Min. 100M $\Omega$				at 500V DC
Dielectric strength	Between non-continuous terminals	1,000 Vrms				
	Between each terminal and other exposed metal parts	1,500 Vrms				
	Between each terminal and ground	1,500 Vrms				
Contact resistance (Initial)		Max. 50 m $\Omega$	Max. 100 m $\Omega$	Max. 50 m $\Omega$	Max. 100 m $\Omega$	Ag alloy contact type: by voltage drop 1 A, 6 to 8V DC Au-clad contact type: by voltage drop 0.1 A, 6 to 8V DC
Vibration resistance (Pin plunger type)		10 to 55 Hz at single amplitude of 0.75mm				Contact opening: Max. 1 msec.
Shock resistance (Pin plunger type)		294 m/s <sup>2</sup> min. (OF 0.98 N type) 147 m/s <sup>2</sup> min. (OF 0.49 N type)	294 m/s <sup>2</sup> min. (OF 0.98 N type) 147 m/s <sup>2</sup> min. (OF 0.49 N type) 49 m/s <sup>2</sup> min. (OF 0.25 N type)	Min. 294 m/s <sup>2</sup>	Min. 294 m/s <sup>2</sup>	Contact opening: 1 msec. max.
Allowable operating speed (no load)		0.1 to 1,000 mm/sec.				
Max. operating cycle rate (no load)		300 cpm				
Ambient temperature		-25°C to +85°C				no freezing and condensing
Unit weight		Approx. 2g				
Protection grade		IP40				

Note: Test conditions and judgement are complying with "NECA C4505".

## ■ Operating characteristics

### 1) Pin plunger

4th digit number of Part No.	Operating Force OF, Max.	Release Force RF, Min.	Pretravel PT, Max.	Movement Differential MD, Max.	Overtravel OT, Min.	Operating Position OP
0	0.25N	0.020N	0.6mm	0.1mm	0.4mm	Distance from mounting holes: 8.4±0.3mm Distance from stand-off: FS 11.8±0.4mm FS-T 11.7±0.4mm
2	0.49N	0.074N				
4	0.98N	0.15N				
5	1.47N	0.20N				

### 2) Short hinge lever

4th digit number of Part No.	Operating Force OF, Max.	Release Force RF, Min.	Pretravel PT, Max.	Movement Differential MD, Max.	Overtravel OT, Min.	Operating Position OP
0	0.098N	0.004N	2.5mm	0.5mm	0.8mm	Distance from mounting holes: 8.8±0.8mm Distance from stand-off: FS 12.2±0.9mm FS-T 12.1±0.9mm
2	0.20N	0.017N				
4	0.39N	0.034N				
5	0.59N	0.039N				

### 3) Hinge lever

4th digit number of Part No.	Operating Force OF, Max.	Release Force RF, Min.	Pretravel PT, Max.	Movement Differential MD, Max.	Overtravel OT, Min.	Operating Position OP
0	0.078N	0.003N	2.8mm	0.8mm	1.2mm	Distance from mounting holes: 8.8±0.8mm Distance from stand-off: FS 12.2±0.9mm FS-T 12.1±0.9mm
2	0.16N	0.015N				
4	0.34N	0.029N				
5	0.54N	0.034N				

### 4) Long hinge lever

4th digit number of Part No.	Operating Force OF, Max.	Release Force RF, Min.	Pretravel PT, Max.	Movement Differential MD, Max.	Overtravel OT, Min.	Operating Position OP
0	—	—	3.5mm	1.0mm	1.6mm	Distance from mounting holes: 8.8±1.2mm Distance from stand-off: FS 12.2±1.3mm FS-T 12.1±1.3mm
2	0.12N	0.012N				
4	0.25N	0.025N				
5	0.44N	0.029N				

### 5) Simulated roller lever

4th digit number of Part No.	Operating Force OF, Max.	Release Force RF, Min.	Pretravel PT, Max.	Movement Differential MD, Max.	Overtravel OT, Min.	Operating Position OP
0	—	—	2.8mm	0.8mm	1.2mm	Distance from mounting holes: 11.65±0.8mm Distance from stand-off: FS 15.05±0.9mm FS-T 14.95±0.9mm
2	0.16N	0.015N				
4	0.34N	0.029N				
5	0.54N	0.034N				

### 6) Roller lever

4th digit number of Part No.	Operating Force OF, Max.	Release Force RF, Min.	Pretravel PT, Max.	Movement Differential MD, Max.	Overtravel OT, Min.	Operating Position OP
0	—	—	2.5mm	0.5mm	0.8mm	Distance from mounting holes: 14.5±0.8mm Distance from stand-off: FS 17.9±0.9mm FS-T 17.8±0.9mm
2	0.20N	0.017N				
4	0.39N	0.034N				
5	0.59N	0.039N				

# AV3/AVM3/AVT3/AVL3 (FS/FS-T) Subminiature Switches

## DIMENSIONS

(Unit: mm) General tolerance:  $\pm 0.25$

The CAD data of the products with a **CAD Data** mark can be downloaded from: <http://industrial.panasonic.com/ac/e/>

### FS switches (In-line terminal type)

#### 1) Self-standing PC board terminal

#### Pin plunger

#### CAD Data

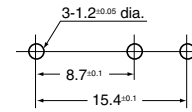
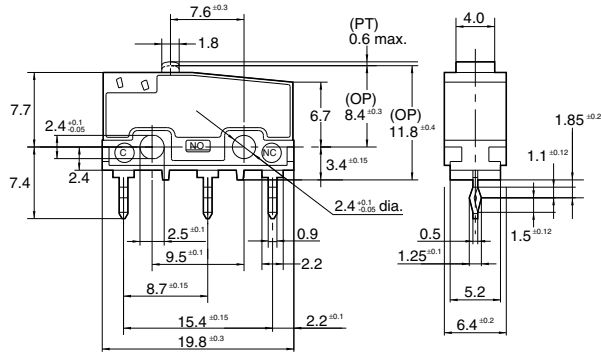

Pretravel PT, Max.	0.6mm	
Movement Differential MD, Max.	0.1mm	
Overtravel OT, Min.	0.4mm	
Operating Position OP	Distance from mounting hole	8.4 $\pm$ 0.3mm
	Distance from stand-off	11.8 $\pm$ 0.4mm

#### Short hinge lever

#### CAD Data

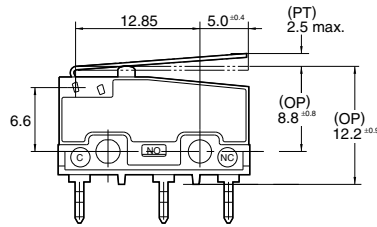

Pretravel PT, Max.	2.5mm	
Movement Differential MD, Max.	0.5mm	
Overtravel OT, Min.	0.8mm	
Operating Position OP	Distance from mounting hole	8.8 $\pm$ 0.8mm
	Distance from stand-off	12.2 $\pm$ 0.9mm

#### Hinge lever

#### CAD Data

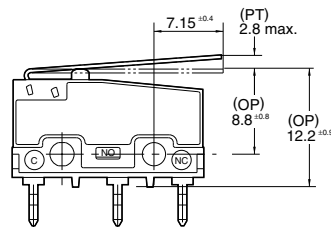

Pretravel PT, Max.	2.8mm	
Movement Differential MD, Max.	0.8mm	
Overtravel OT, Min.	1.2mm	
Operating Position OP	Distance from mounting hole	8.8 $\pm$ 0.8mm
	Distance from stand-off	12.2 $\pm$ 0.9mm

#### Long hinge lever

#### CAD Data

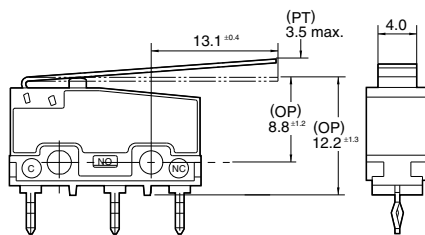

Pretravel PT, Max.	3.5mm	
Movement Differential MD, Max.	1.0mm	
Overtravel OT, Min.	1.6mm	
Operating Position OP	Distance from mounting hole	8.8 $\pm$ 1.2mm
	Distance from stand-off	12.2 $\pm$ 1.3mm

#### Simulated roller lever

#### CAD Data

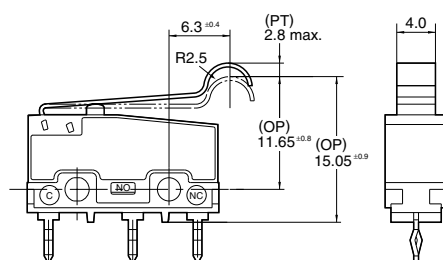

Pretravel PT, Max.	2.8mm	
Movement Differential MD, Max.	0.8mm	
Overtravel OT, Min.	1.2mm	
Operating Position OP	Distance from mounting hole	11.65 $\pm$ 0.8mm
	Distance from stand-off	15.05 $\pm$ 0.9mm



# AV3/AVM3/AVT3/AVL3 (FS/FS-T) Subminiature Switches

## Roller lever

### CAD Data

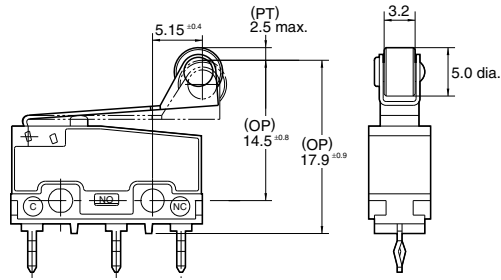

Pretravel PT, Max.	2.5mm	
Movement Differential MD, Max.	0.5mm	
Overtravel OT, Min.	0.8mm	
Operating Position OP	Distance from mounting hole	14.5±0.8mm
	Distance from stand-off	17.9±0.9mm

## 2) Solder terminal

### CAD Data

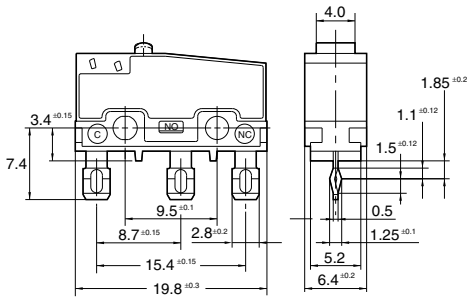

Note: Dimensions other than drawn above is same as self-standing PC board terminal.

## 3) .110 Quick-connect terminal

### CAD Data

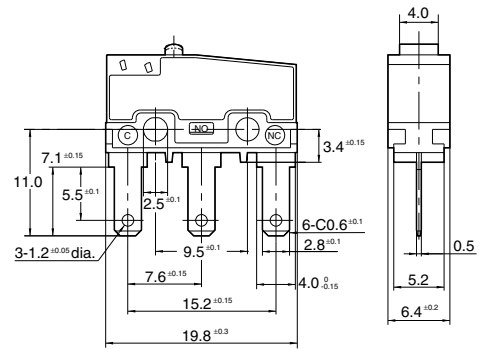

Note: Dimensions other than drawn above is same as self-standing PC board terminal.

## FS-T switches (Cross-line terminal type)

### 1) PC board terminal

#### Pin plunger

### CAD Data

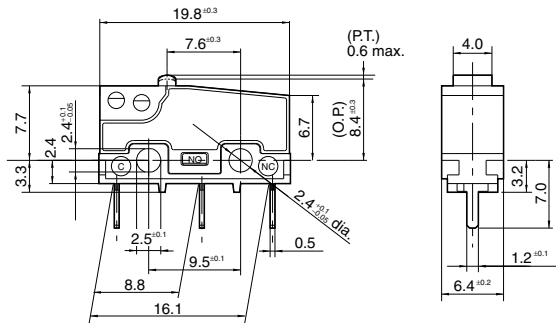

### PC board pattern

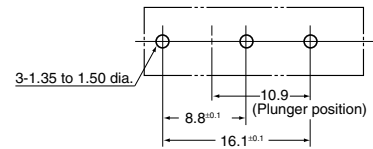

Pretravel PT, Max.	0.6mm	
Movement Differential MD, Max.	0.1mm	
Overtravel OT, Min.	0.4mm	
Operating Position OP	Distance from mounting hole	8.4±0.3mm
	Distance from stand-off	11.7±0.4mm

## Short hinge lever

### CAD Data

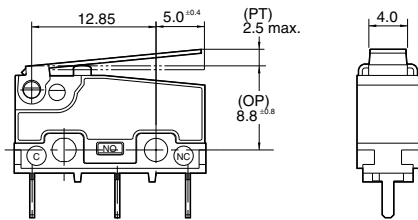

Pretravel PT, Max.	2.5mm	
Movement Differential MD, Max.	0.5mm	
Overtravel OT, Min.	0.8mm	
Operating Position OP	Distance from mounting hole	8.8±0.8mm
	Distance from stand-off	12.1±0.9mm

## Hinge lever

### CAD Data

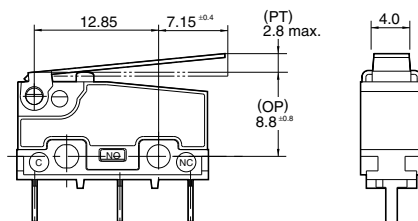

Pretravel PT, Max.	2.8mm	
Movement Differential MD, Max.	0.8mm	
Overtravel OT, Min.	1.2mm	
Operating Position OP	Distance from mounting hole	8.8±0.8mm
	Distance from stand-off	12.1±0.9mm

# AV3/AVM3/AVT3/AVL3 (FS/FS-T) Subminiature Switches

## Long hinge lever

### CAD Data

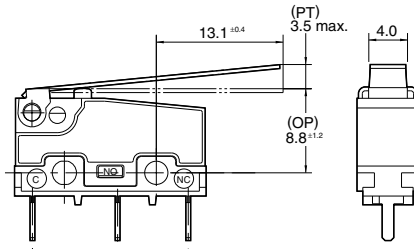

Pretravel PT, Max.		3.5mm
Movement Differential MD, Max.		1.0mm
Overtravel OT, Min.		1.6mm
Operating Position OP	Distance from mounting hole	8.8±1.2mm
	Distance from stand-off	12.1±1.3mm

## Simulated roller lever

### CAD Data

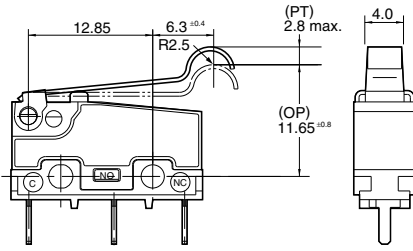

Pretravel PT, Max.		2.8mm
Movement Differential MD, Max.		0.8mm
Overtravel OT, Min.		1.2mm
Operating Position OP	Distance from mounting hole	11.65±0.8mm
	Distance from stand-off	14.95±0.9mm

## Roller lever

### CAD Data

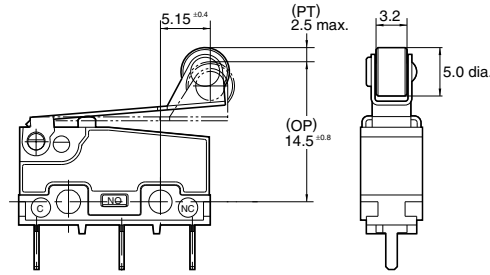

Pretravel PT, Max.		2.5mm
Movement Differential MD, Max.		0.5mm
Overtravel OT, Min.		0.8mm
Operating Position OP	Distance from mounting hole	14.5±0.8mm
	Distance from stand-off	17.8±0.9mm

## 2) Solder terminal

### CAD Data

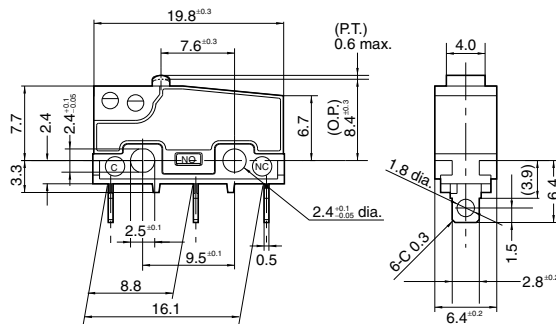

Note: As for the dimensions of lever types, dimensions other than terminals are same as PC board terminal.

## 3) .110 Quick-connect terminal

### CAD Data

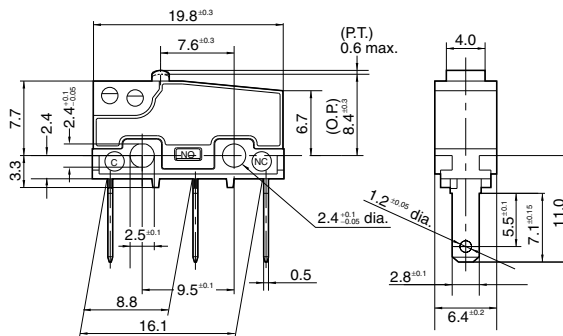

Note: As for the dimensions of lever types, dimensions other than terminals are same as PC board terminal.

**CAUTIONS FOR USE** (Common for FS type and FS-T type)

■ **Regarding fastening of switch body**

- 1) To secure the switch, please use an M2.3 small screw on a flat surface and tighten using a maximum torque of 0.29 N·m. It is recommended that spring washers be used with the screws and adhesive be applied to lock the screws to prevent loosening of the screws.
- 2) When the operation object is in the free position, force should not be applied directly to the actuator or pin plunger. Also force should be applied to the pin plunger from vertical direction to the switch.
- 3) In setting the movement after operation, the Overtravel OT should be set not less than 70% as a standard. Setting the movement at less than 70% of OT may cause troubles such as mis-contact and welding due to small contact force of the switch.

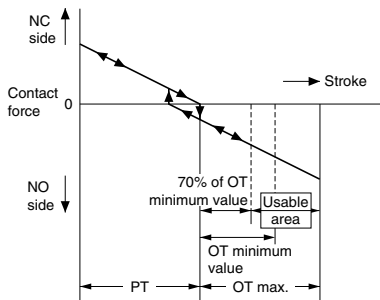

In addition, even if FS type switch actuator is pushed to full limit of operating position, it does not affect product life. However, heavy impact and excessive loading should not be applied.

■ **Soldering operation**

Perform soldering in less than 3 seconds with maximum 350°C iron. Care should be taken not to apply force to the terminals during soldering. We recommend a soldering iron with temperature adjustment in order to prevent poor quality soldering.

Please consult us if you intend to use a soldering iron of 60 W or higher.

■ **Environment**

Locations where corrosive gases having a bad influence on contacts are present, and locations where there is an excessive amount of siliceous or other abrasive dust should be avoided.

■ **Regarding connector connections (.110 quick connect terminals)**

For making connections, a dedicated receptacle for .110 quick connect terminals should be used, and the terminals should be inserted parallel to the receptacle. Consideration should be given to mounting so that no tensile load is applied to the lead wires.

■ **In making the switch selection**

Consideration should be given to provide for no interference up to +20% variation of the standard characteristics values.

**3P CONNECTOR**

(Both AV3/AVM3 subminiature switches and ABS turquoise switches)

The .110 Quick-connect terminal type of S type turquoise switches and FS type subminiature switches fit direct contact 3P connectors (Nippon Tanshi Co., Ltd.)

■ **Reverse insertion prevention**

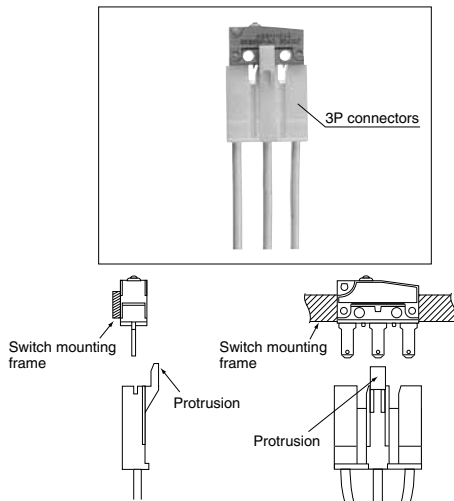

As shown in the diagram, the protrusion on the 3P connector can only be inserted on the corresponding side of the mounting frame. That is, using the plunger as a reference, the subminiature switches can only be inserted in the direction shown in the diagram: it is not possible to mount it the wrong way round.

■ **If you have any questions, please directly contact:**  
Nippon Tanshi Co., Ltd.

■ **Product name and Product number**

Product name: 3P connectors for 7.6 mm pitch subminiature switches

Product number

Name	Product number	Remark (Suitable wire)
Housing	9880-4203	—
Receptacle	171587-M2	0.3 to 0.75 mm <sup>2</sup>

Note: Please note that Panasonic does not sell this connector.

# Technical Terminology & Cautions for Use

## (Detection Switches)

### TECHNICAL TERMINOLOGY

#### ■ Detection Switches

A compact switch equipped with an enclosed micro-gap snap-action contact mechanism that makes a specified motion with a specified force to open/close a circuit, and an actuator outside the enclosure (hereinafter referred to as the switch)

#### ■ Actuator

A part of the switch that transmits the received external force to an internal spring mechanism to move the movable contact so that the switch can be opened and closed

#### ■ Actuator stopper

A part of the switch to limit the actuator movement in the switch operation direction

#### ■ Rated values

Values indicating the characteristics and performance guarantee standards of the snap-action switches. The rated current and rated voltage, for instance, assume specific conditions (type of load, current, voltage, frequency, etc.).

#### ■ Mechanical life



The service life when operated at a preset operating frequency without passing electricity through the contacts. (The life test is performed at a switching frequency of 60 times/minute and operating speed of 100 mm/second at the regular cam.)

#### ■ Electrical life

The service life when the rated load is connected to the contact and switching operations are performed. (The life test is performed at a switching frequency of 20 times/minute and operating speed of 100 mm/second at the regular cam.)

#### ■ Contact form

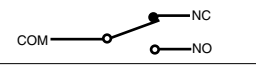
This refers to the components determining the type of application which make up the electrical input/output circuits in the contact.

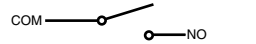
SPDT	
SPST-NC	
SPST-NO	

Terminal symbols

COM: Common terminal

NC: Normally closed terminal

NO: Normally open terminal

#### ■ Insulation resistance

Resistance between non-continuous terminals, each terminal and other exposed metal parts and between each terminal and ground.

#### ■ Dielectric

Threshold limit value that a high voltage can be applied to a predetermined measuring location for one minute without causing damage to the insulation.

#### ■ Contact resistance

This indicates the electrical resistance at the contact part. Generally, this resistance includes the conductor resistance of the spring and terminal portions.

#### ■ Vibration resistance

Malfunction vibration ... Vibration range where a closed contact does not open for longer than a specified time due to vibrations during use of the snap-action switches.

#### ■ Shock resistance

Shock durability ... Shock range where the mechanical shocks received during snap-action switches transport and installation do not damage the parts or harm the operating characteristics. Malfunction shock ... Shock range where a closed contact does not open for longer than a specified time due to shocks during use of the snap-action switches.

## OPERATING CHARACTERISTIC

### ■ Definition of operating characteristic

The main terminological illustrations and meanings which are used with snap-action switches are as follows.

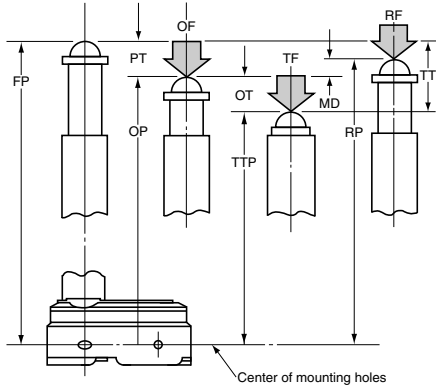

Classification	Terminology	Symbol	Unit	Varying display method	Starting current
Force	Operating Force	OF	N	Max.	The force required to cause contact snap-action. It is expressed in terms of force applied to the actuator.
	Release Force	RF	N	Min.	The force to be applied to the actuator at the moment contact snaps back from operated position to total travel position.
	Total travel Force	TF	N		Force applied to an actuator required to move from an operating position to a total travel position
Movement	Pretravel	PT	mm, degree	Max.	Distance or degree of the actuator movement from free position to operating position.
	Overtravel	OT	mm, degree	Min.	The distance or degree which the actuator is permitted to travel after actuation without any damage to the switching mechanism.
	Movement Differential	MD	mm, degree	Max.	The distance or degree from operating position to release position of the actuator.
	Total travel	TT	mm, degree		The migration length or the move angle from the free position to total travel position of actuator
Position	Free Position	FP	mm, degree		Position of the actuator when no force is applied to.
	Operating Position	OP	mm, degree	±	The position of the actuator when the traveling contacts snaps with the fixed contact.
	Release Position	RP	mm, degree		The position of the actuator when the traveling contact snaps back from operating position to its original position.
	Total travel Position	TTP	mm, degree		The stopping position of the actuator after total travel.

## TECHNICAL NOTES ON MECHANICAL CHARACTERISTICS

### ■ Actuation Force and Stroke

Adequate stroke setting is the key to high reliability. It is also important that adequate contact force be maintained to ensure high reliability. For a normally closed (NC) circuit, the driving mechanism should be set so that the actuator is normally in the free position. For a normally open (NO) circuit, the actuator should be pressed to 70% to 100% of the specified stroke to absorb possible errors.

If the stroke is set too close to the operating point (OP), this may cause unstable contact, and in the worst case may cause actuator damage due to inertia of the drive mechanism. It is advisable that the stroke be adjusted with the mounting plate or driving mechanism.

The figure at right shows a typical example of activation and contact forces varying with stroke. In the vicinity of the OP and RP, the contact force is diminished, causing chatter and contact bounce immediately before or after reversal. For this reason, use the switch while giving due consideration to this. This also causes the snap action switch to be sensitive to vibration or shock.

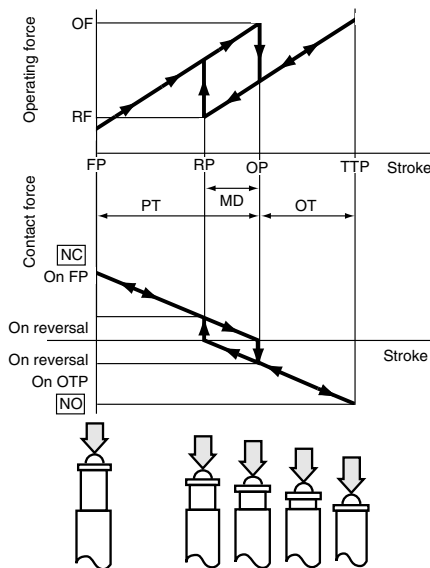

### ■ Changes in Operating Characteristics

Exercise design care so that malfunctions will not occur if the operating characteristics vary by as much as 20% from, rated values.

<Example>

In the OF max. 0.98N specification for FS snap-action switches, the allowable max. is  $0.98 \text{ N} \times (100\%+20\%) = 1.18 \text{ N}$

In the RF min. 0.15 N min. specification

the allowable min.  $0.15 \text{ N} \times (100\%-20\%) = 0.12 \text{ N}$

### ■ Mechanical Conditions for Type Selection

Actuator type should be selected according to activation method, activation speed, activation rate, and activation frequency.

- 1) An extremely slow activation speed may cause unstable contact transfer, possibly resulting in contact failures or contact fusion.
- 2) An extremely high activation speed may cause damage to contacts or contact response failure.

### ■ Driving Mechanism

Use of a driving mechanism which will cause physical impact to the actuator should be avoided.

<Example>

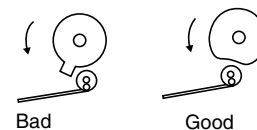

## TECHNICAL NOTES ON ELECTRICAL CHARACTERISTICS

1) The snap-action switch is designed for AC operations. While it has small contact gaps and no arc absorber, it may be used for low-capacity DC operations.

Please refer to the rating of each products

2) For applications with very small switching voltage or current, choose the low-level load type (Au contact).

Small current and voltage application range (Au contact)

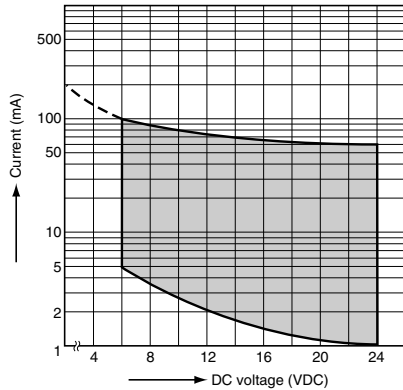

3) When selecting a contact type of a snap-action switch to be used for low-level load switching, the following should be noted. Silver contacts' surfaces are prone to be oxidized and form a sulfide film. The switch operates with no problems at the

beginning of use. However, as the contact surfaces develop films with time, the film may not be broken by the switching operation, causing a conduction failure. Therefore, please choose the Au contact type for switching a load of 0.1 A or below.

4) Application to Electronic Circuits

- The snap-action switch contacts can sustain bounce or chatter when closed. Bounce or chatter can cause noise or pulse count errors when the snap action switch is used in electronic circuits.

- If contact bounce or chatter poses problems in the vicinity of the OP and RP, use a suitable absorption network, such as a C/R network.

5) Check the surge current, normal current and surge duration.

6) Contact resistance given in performance specifications is measured with a voltage drop method using 6 to 8 V DC, 1 A (except for low-level load type). Contact resistance across COM and NC terminals is measured in the free position, while contact resistance across COM and NO terminals is measured in the total travel position.

7) To prevent contact welding failure, be sure to use a serial resistance for each capacitive load.

8) If snap-action switch operation is synchronized with the AC supply phase, this may cause: shortened electrical life, contact fusion failure, contact transfer, or other reliability problems.

## CAUTIONS IN A CIRCUIT

1) Contact protection is recommended when snap-action switches are used in an inductive load circuit.

Circuit diagram	Cautions for use
	(1) $r = \text{more than } 10 \Omega$ (2) In an AC circuit Impedance of R is to be slightly smaller than impedance of r and c.
	Can be used for both AC and DC. Impedance of r is nearly equal to impedance of R. C: $0.1 \mu\text{F}$
	(1) For DC circuits only.
	Can be used for both AC and DC.

2) Do not connect the contacts on individual switches to different type or different poles of the power supply. Examples of power supply connections (connection to different poles)

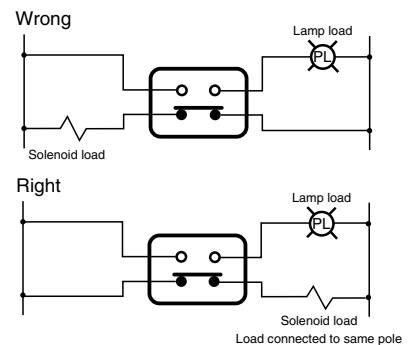

Example of wrong power supply connection (connection to different poles of power supply) This may lead to mixed DC and AC.

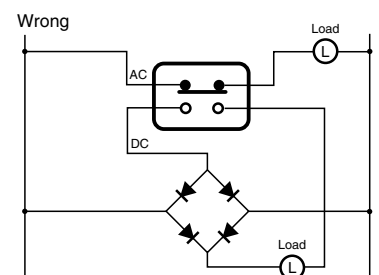

3) Avoid circuits which apply voltage between contacts. (This may lead to mixed deposition.)

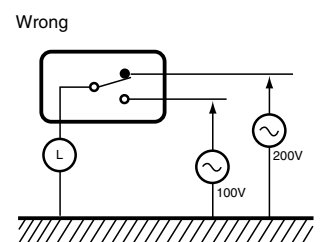

## MOUNTING STATE AND ENVIRONMENT

### ■ Checking the insulation distance

After mounting and wiring, check the insulation distance between terminals and the ground. If the insulation distance is inadequate, mount insulating material between as required.

### ■ Fastening the snap-action switch body

See the Section "CAUTIONS FOR USE" for the individual switch.

### ■ Position adjustment with effector

- 1) The effector should be positioned so that direct force is not applied to the plunger or actuator in its free position. The operating force to the plunger should only be applied in a perpendicular direction.
- 2) Note that the use of the switch as a stopper may cause an operational problem.

### ■ Switch installation position

- Basically, the switch should be installed so that the object to press the switch's plunger or lever can press it down to 70 to 100% of OT of the switch. When determining the position, the tolerance of OP (Operating Position) and other factors should be taken into account.

The following describes the case where the strictest tolerance conditions are adopted.

- Example: Hinge lever type FS switch

Reference values: OP =  $8.8 \pm 0.8$ mm  
 PT = max. 2.8mm  
 OT = min. 1.2mm

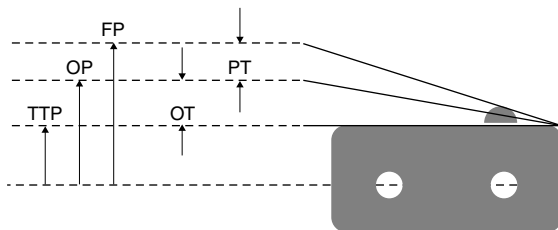

- (1) When the switch is not pressed  
 The object to press the lever should not be in contact with the lever.  
 For this purpose, the object should be at a distance from the switch fater than the maximum FP (Free Position) value.  
 $FP \text{ max} = OP \text{ max} + PT \text{ max} = 9.6 + 2.8 = 12.4 \text{ mm max}$   
 The object should be at a distance of 12.4 mm or more from the mounting hole.
- (2) Depressed position  
 The plunger/lever should be pressed down to 70% or more of OT (Over Travel). Therefore, the depressed position should be calculated based on the minimum value of OP (Operating Position) and the 70 and 100% of the OT value.  
 $OP \text{ min} - 70\% \text{ of OT} = 8.0 - 0.84 = 7.16 \text{ mm}$   
 $OP \text{ min} - 100\% \text{ of OT} = 8.0 - 1.2 = 6.80 \text{ mm}$   
 The plunger/lever should be pressed down to the position of 6.80 to 7.16 mm from the mounting hole.

### ■ Soldering precautions

For manual soldering, lay the terminals flat (horizontal with the ground) and quickly perform the soldering operation using a soldering iron with the appropriate heat capacity and the proper amount of solder. Take care that the flux does not flow into the switch interior by using a ventilation fan to discharge flux gas and to prevent contact of the switch body with the soldering iron tip.

Be careful not to apply force to the lead wires or the terminal portions immediately after soldering.

The temperature setting and time conditions vary depending on the product.

See the section "CAUTIONS FOR USE" for each product.

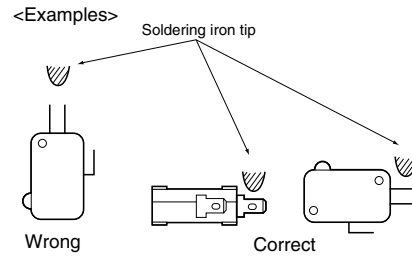

### ■ Avoid using in a silicon atmosphere

Avoid using organic silicon rubber, adhesives, sealing compounds, oil, grease, and wires in a silicon atmosphere.

### ■ Please consult us when using under the following conditions\*:

- 1) Environments where hydrogen sulfide or other corrosive gases are present.
- 2) Environments where gasoline, thinner or other flammable, explosive gases are present.
- 3) Dusty environments (for non-seal type snap action switches).
- 4) The perpendicular operating speed exceeds the allowable operating speed.
- 5) Switching between different poles.
- 6) Use in environments not in the prescribed temperature or humidity range.

### ■ Storage precautions

To prevent discoloration due to sulfurization of the terminals (silver-plated), store the switches in a polyethylene bag or other suitable airtight container.

## ■ Usage, storage, and transport conditions (except turquoise switches)

During usage, storage, or transportation, avoid locations subject to direct sunlight and maintain normal temperature, humidity, and pressure conditions.

The allowable specifications for environments suitable for usage, storage, and transportation are given below.

1) Temperature: The allowable temperature range differs for each switch, so refer to the switch's individual specifications. In addition, when transporting or storing switches while they are tube packaged, there are cases when the temperature may differ from the allowable range. In this situation, be sure to consult the individual specifications.

2) Humidity: The allowable humidity range differs for each switch, so refer to the switch's individual specifications.

3) Pressure: 86 to 106 kPa

The humidity range varies with the temperature. Use within the range indicated in the graph below.

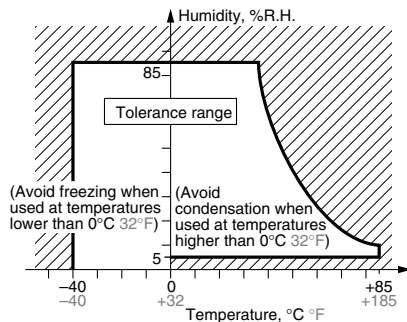

(The allowable temperature depends on the switch.)

- Condensation will occur inside the switch if there is a sudden change in ambient temperature when used in an atmosphere of high temperature and high humidity. This is particularly likely to happen when being transported by ship, so please be careful of the atmosphere when shipping. Condensation is the phenomenon whereby steam condenses to cause water droplets that adhere to the switch when an atmosphere of high temperature and humidity rapidly changes from a high to low temperature or when the switch is quickly moved from a low humidity location to one of high temperature and humidity. Please be careful because condensation can cause adverse conditions such as deterioration of insulation, coil cutoff, and rust.
- Condensation or other moisture may freeze on the switch when the temperatures is lower than 0°C 32°F. This causes problems such as sticking of movable parts or operational time lags.
- The plastic becomes brittle if the switch is exposed to a low temperature, low humidity environment for long periods of time.
- Storage for extended periods of time (including transportation periods) at high temperatures or high humidity levels or in atmospheres with organic gases or sulfide gases may cause a sulfide film or oxide film to form on the surfaces of the contacts and/or it may interfere with the functions. Check out the atmosphere in which the units are to be stored and transported.
- In terms of the packing format used, make every effort to keep the effects of moisture, organic gases and sulfide gases to the absolute minimum.

■ We reserve the right to modify without notice the materials, internal components, and other parts to improve product quality.

## ■ Handling precautions

When handling the switches, be careful not to drop them on the floor since this may damage them.

\* Select contact sulfurization (clipping) prevention products (FS and Au-clad double layer contacts) for use with extremely small loads or an environment-resistant Turquoise switch.

## ■ Others













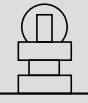

1) Failure modes of switches include short-circuiting, open-circuiting and temperature rises. If this switch is to be used in equipment where safety is a prime consideration, examine the possible effects of these failures on the equipment concerned, and ensure safety by providing protection circuits or protection devices. In terms of the systems involved, make provision for redundancy in the design and take steps to achieve safety design.

2) The ambient operating temperature (and humidity) range quoted is the range in which the switch can be operated on a continuous basis: it does not mean that using the switch within the rating guarantees the durability performance and environment withstanding performance of the switch. For details on the performance guarantee, check the specifications of each product concerned.



# Technical Terminology & Cautions for Use

## ■ Types of actuators

Shape	Classification	Pretravel (PT)	Overtravel (OT)	Operating Force (OF)	Vibration Shock	Features	
	Pin plunger	Small	Small	Large	Out-standing	Appropriate for linear short-stroke action. Pin plunger acts directly on snap action mechanism, enabling high-precision positioning. Amount of movement after operation is smallest among all of the actuators, however, so reliable stopper is required.	
	Spring small plunger	Small	Medium	Large	Excellent	Used in much the same way as the pin plunger, but is easier to use because the amount of movement after operation is larger.	
	Spring short plunger	Small	Medium	Large	Good	Pin plunger is short, with large plunger diameter that makes centering easier. Like small spring plunger, amount of movement after operation is large.	
	Panel attachment plunger	Small	Large	Large	Good	Secured to panel with hex or lock nut; used as manual or mechanical plunger. Amount of movement after operation is extremely large and operation point can be adjusted by changing attachment position. Can be used in combination with low-speed cam.	
	Panel attachment roller plunger	Small	Large	Large	Possible	This is the panel attachment type with a roller, and can be used with fast-moving cams and dogs..	
	Hinge lever	Large	Medium	Small	Possible	Little force required for operation. Appropriate for use with low-speed cams and dogs; has large stroke. Lever available in various shapes to fit operating unit.	
	Simulated roller lever	Large	Medium	Small	Possible	Tip of hinge lever is bent into a semi-circle, enabling use as a simple roller type.	
	Leaf lever	Large	Large	Small	Excellent	Play in lever is used to assure maximum stroke. Construction provides for space where lever is attached, for outstanding resistance to freezing.	
	Hinge roller lever	Large	Medium	Small	Possible	This is a hinge lever with a roller, and can be used with high-speed cams and dogs. The force required for pin plunger action is lighter than that of the lever, and the stroke is longer.	
	One way action hinge roller lever	Medium	Medium	Medium	Possible	This is hinge roller lever type, and can operate in relation to an operating unit from a one way direction, but the roller is bent from the opposite direction and cannot move. This can be used to prevent reverse-direction action.	
	Leaf spring	Medium	Medium	Medium	Good	This has a leaf spring with offset yield force and has a large stroke. Ideal for driving low-speed cams and cylinders. Fulcrum is fixed for high precision. To prevent leaf damage, movement after operation must be within specified value.	
	Roller leaf spring	Medium	Medium	Medium	Good	This is a leaf spring with a roller, and can be used with high-speed cams.	
	(OC reversed action groove type) Reverse-action hinge lever	Large	Small	Medium	Excellent	This is used for low-speed, low-torque cams. The lever comes in various shapes to fit the operating body.	The plunger is constantly pressed down by a coiled spring, and operating the lever induces reverse action. Because the plunger is depressed when not engaged, vibration and shock resistance are excellent. Pressing the plunger too far does not cause abnormal force to be applied to the switch mechanism, so a stable service life is assured.
	(OC reversed action groove type) Reverse-action hinge roller lever	Medium	Medium	Medium	Excellent	This is a reverse-action hinge lever with a roller and is appropriate for cam operation. Excellent resistance to vibration and impact when not engaged.	
	(OC reversed action groove type) Reverse-action hinge roller short lever	Small	Medium	Large	Excellent	This is a shorter version of the reverse-action hinge lever with a roller and has a larger action force, but is appropriate for cam operation with a short stroke. Excellent resistance to vibration and impact when not engaged.	

---

Please contact .....

**Panasonic Corporation**

Electromechanical Control Business Division

■ 1006, Oaza Kadoma, Kadoma-shi, Osaka 571-8506, Japan  
[industrial.panasonic.com/ac/e/](http://industrial.panasonic.com/ac/e/)

**Panasonic**<sup>®</sup>

©Panasonic Corporation 2017

---

Please contact .....

**Panasonic Corporation**

Electromechanical Control Business Division

■ 1006, Oaza Kadoma, Kadoma-shi, Osaka 571-8506, Japan  
[industrial.panasonic.com/ac/e/](http://industrial.panasonic.com/ac/e/)

**Panasonic**<sup>®</sup>

©Panasonic Corporation 2017