

LTC4120EUD-4.2/LTC4120EUD Wireless Power Receiver and 400mA Buck Battery Charger

DESCRIPTION

Demonstration circuit DC1969A is a kit of: the DC1967A-A/B [LTC®4120EUD](#) demonstration board, the DC1968A basic wireless transmitter, a 35mm receiver ferrite disk, and an assortment of different length standoffs. The basic transmitter can deliver 2W to the receive board with up to 10mm spacing between the transmit and the receive

coils. The basic transmitter does not support foreign object detection, i.e. coins or other metallic objects.

Design files for this circuit board are available at <http://www.linear.com/demo/DC1969A>

LT, LT, LTC, LTM, Linear Technology and the Linear logo are registered trademarks of Linear Technology Corporation. All other trademarks are the property of their respective owners.

CONTENTS

- 1X DC1967A-A/B (LTC4120EUD) Demo Board
- 1X DC1968A (Wireless Basic Transmitter) Demo Board
- 1X 35mm Ferrite Bead
- 4X 6.25mm (0.25") Nylon Standoffs
- 4X 12.5mm (0.50") Nylon Standoffs
- 4X 15.875mm (0.625") Nylon Standoffs

Kit Build Options

KIT NUMBER	Tx BOARD	Rx BOARD
DC1969A-A	DC1968A	DC1967A-A
DC1969A-B	DC1968A	DC1967A-B

Receiver Board Build Options

Rx BOARD	PART NUMBER	FUNCTION
DC1967A-A	LTC4120EUD-4.2	Fixed 4.2V Float Voltage
DC1967A-B	LTC4120EUD	Adjustable Float Voltage

PERFORMANCE SUMMARY

Specifications are at $T_A = 25^\circ\text{C}$

SYMBOL	PARAMETER	CONDITIONS	MIN	TYP	MAX	UNITS
HVIN	DC1968A High Voltage Input Voltage Range	I _{HVIN} ≤ 500mA at HVIN = 8V	8		38	V
V _{CC}	DC1968A V _{CC} Input Range	I _{V_{CC}} = 0mA to 700mA	4.75		5.25	V
V _{BAT}	DC1967A BAT Pin Voltage	R ₉ = 1.40MΩ, R ₁₀ = 1.05MΩ	2.5		4.25	V
I _{BAT}	DC1967A BAT Pin Current	V _{BAT} = 3.7V, DC1967A(R ₅) = 3.01kΩ	370	385	400	mA

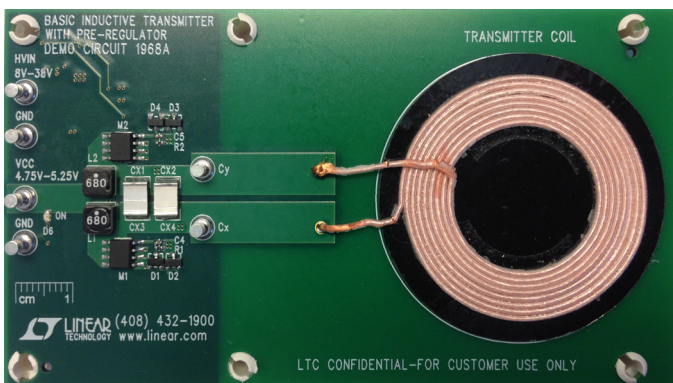

Figure 1. DC1968A Basic Transmitter Board

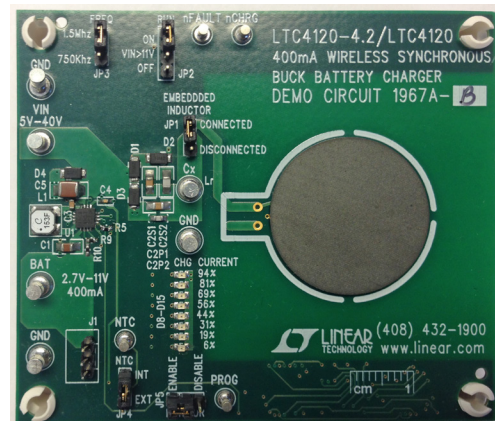

Figure 2. DC1967A-B LTC4120 Receiver Board

dc1969aabfb

DEMO MANUAL

DC1969A-A/DC1969A-B

DEMO BOARD PROCEDURE

Refer to Figure 7 for the proper measurement equipment setup and jumper settings and follow the procedure below. Please test DC1968A first, by itself.

NOTE: When measuring the input or output voltage ripple, care must be taken to avoid a long ground lead on the oscilloscope probe. Measure the input or output voltage ripple by touching the probe tip directly across the V_{CC} or V_{IN} and GND terminals. See Figure 8 for proper scope probe technique.

1. Set PS1 = 36V, observe V_{CC} (VM1) and I_{HVIN} AM1. The DC1968A can be powered by 5V on the V_{CC} pin or up to 38V on the HVIN pins. The HVIN pins are connected to an LT3480 buck regulator that makes 5V at the V_{CC} pins. Standby power in the DC1968A basic transmitter varies between 0.5W and 0.6W, for a V_{CC} current at 5V of 100mA ~ 130mA. If the DC1968A is powered via the HVIN pins then this current is scaled by the ratio $5V/[V_{HVIN} \times 0.92]$, where 0.92 is efficiency of the regulator. So the standby HVIN current is approximately $5.5/[V_{HVIN} \times (100mA \sim 130mA)]$.
2. Remove PS1, VM1 and AM1. Attach PS2 and AM2.
3. Set PS2 to 5V, and observe AM2. The transmitter is being powered directly with no intervening buck regulator, so the standby current should be between 100mA ~ 130mA.

4. Connect a bipolar¹ supply (PS3) to the DC1967A demo board BAT pin. Set the supply to 3.7V and turn on. Observe AM3.
5. Place the DC1967A board atop the DC1968A board, by aligning:

DC1967A Mounting Hole		DC1968A Mounting Hole
MH1	=>	MH1
MH2	=>	MH2
MH3	=>	MH3
MH4	=>	MH4

This should result in the transmit antenna being directly above the receive antenna, with the centers aligned. Observe AM2 and AM3. All the charge LEDs on the DC1967A should now be lit. AM2 should have increased from 100mA ~ 130mA to about 600mA. AM3 should be reading 380mA ~ 400mA of charge current into the battery emulator.

Figure 6 shows the approximate full power (400mA of charge current into 4.15V ~ 1.7W) and half power contours.

¹ A bipolar supply can both sink and source current to maintain the correct output voltage. A unipolar supply can be converted into a suitable bipolar supply by putting a 3.6Ω, 10W, resistor across the output.

THEORY OF OPERATION

The DC1969A kit demonstrates operation of a double tuned magnetically coupled resonant power transfer circuit.

DC1968A – Basic Transmitter

The DC1968A Basic Transmitter is used to transmit wireless power and is used in conjunction with the DC1967A wireless power receiver board featuring the LTC4120.

The DC1968A is configured as a current fed astable multi-vibrator, with oscillation frequency set by a resonant tank.

The DC1968A basic transmitter is set to 130kHz operation and the DC1967A LTC4120 demonstration board resonant frequency is 127kHz with DHC enabled and 140kHz with DHC disabled. For the DC1968A basic transmitter the resonant components are the 2X 0.15μF PPE film capacitors (Cx1 and Cx2) and the 5.0μH (Lx) transmit coil. This gives a resonant frequency of 129.95kHz. The tolerance on the transmit coil and resonant capacitors is ±2%, or 2.6kHz. Inductors L1 and L2 are used to make the resonant structure current fed.

THEORY OF OPERATION

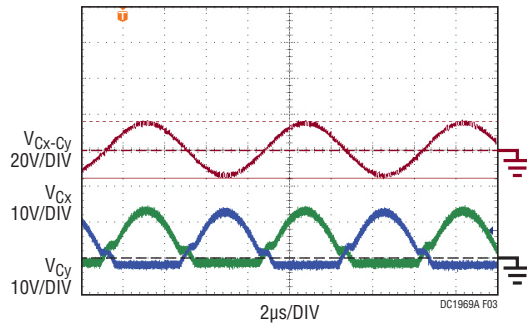

Figure 3. DC1968A Basic Transmitter

The current fed topology makes the peak-to-peak voltage on the resonant tank equal to $2\pi V_{CC}$. V_{CC} is 5V, so the peak-to-peak tank voltage is 31.5V, see Figure 3.

The blue and green traces are the drains of the transmitter MOSFETs M1 and M2 (see Figure 12), respectively. The red trace is the difference ($V_{CX} - V_{CY}$) of those two nodes, and shows that the resonant tank is producing a sine wave. The peak-to-peak voltage of $2\pi V_{CC} = 31.5V$, results from the current fed topology. This in turn determines the breakdown of the MOSFETS and diodes D2 and D3. To increase transmit power by raising V_{CC} , you must also change M1, M2, D2 and D3, to reflect the higher voltages on the C_X and C_Y nodes.

The magnitude of the magnetic field is directly proportional to the current in the transmit coil. For a resonant system this current is Q times the input current. So the higher the Q the larger the magnetic field. Therefore the transmit coil is constructed with Litz wire, and the resonant capacitors are very low dissipation PPS film capacitors. This leads to a Q of approximately 10 at 130kHz, and a circulating current of approximately $6A_{P-P}$, at full load.

DC1967A – Wireless Power Receiver Board Featuring the LTC4120

The LTC4120 wireless power receiver IC implements dynamic harmonization control (DHC), which tunes or detunes the receive circuit to receive more or less power as needed. The primary receive tank is composed of L_r , and C_{2S} , although it must be noted that C_{2S} is ac grounded through C_5 , the LTC4120 decoupling capacitor, to be in parallel with L_r . C_{2S} also serves to tap power off the resonant circuit and send it to the LTC4120, see Figure 4.

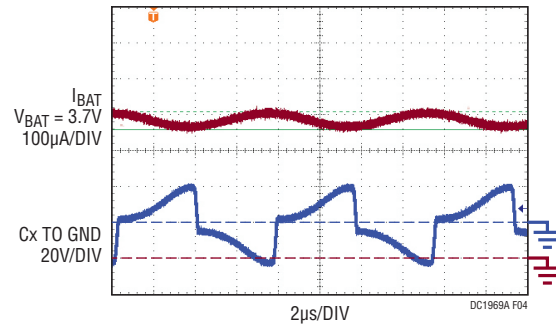

Figure 4. DC1967A Receiver

The waveforms in Figure 4 were captured at a transmit to receive gap of 8mm. The blue trace is the waveform at the C_X pin of the receiver board (Figure 10), and the red trace is the charge current into the battery. Although the transmit waveform is a sine wave, the series-parallel connection of the secondary resonant circuit does not yield a sine wave, and this waveform is correct. The charge current into the battery has an average of $\approx 400mA$, for a delivered power of 1.5W ($V_{BAT} = 3.7V$). However, 20mA has been diverted to the charge LEDs, for a net battery charge current of 380mA. The ripple on the charge current is synchronous to the transmit waveform.

DHC

When V_{IN} is above 14V, the DHC pin is open and C_{2P} doesn't enhance the energy transfer; this is the detuned state, and the resonant frequency of the receive tank is 142kHz. When V_{IN} falls below 14V, the DHC pin is grounded putting C_{2P} in parallel with both C_{2S} and L_r thus changing the resonant frequency to 127.4kHz. When the receiver is tuned at 127.4kHz and drawing significant power, the transmit frequency is pulled down to 127kHz. So, at full power the system is now a double-tuned resonant circuit. Figure 6 shows approximate power transfer vs distance between transmitter and receiver. Note the minimum clearance. The minimum is needed to avoid exceeding the maximum input voltage.

Summary

The LTC4120 wireless power receiver IC adjusts the receiver resonant frequency to keep the system from transferring too much power when the coupling is high between transmit

THEORY OF OPERATION

and receive coils. The LTC4120 wireless power receiver IC increases power transfer when power transfer is insufficient. This is accomplished by switching capacitors into the resonant circuit using the DHC pin. This gives a much wider operating transmit distance, see Figure 5.

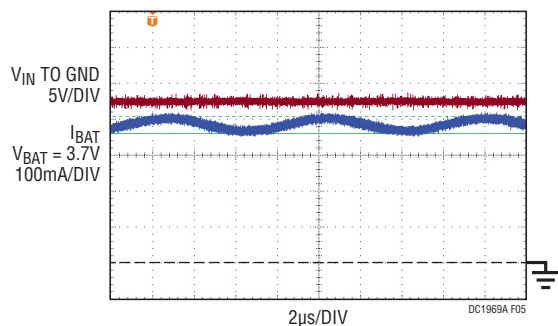

Figure 5. DC1967A Receiver

The blue trace is the charge current into the battery, and the red trace is the voltage at V_{IN} on the receiver board. V_{IN} is about 25V, while the LTC4120 delivers 1.5W at a

distance of 8mm, to the battery. There is negligible transmit frequency ripple on V_{IN} , and the voltage is well above the 14V DHC voltage. This indicates that the input rectifiers are operating in peak detect mode, and that DHC is inactive.

35mm Ferrite Disk

The DC1969A-A/DC1969A-B kit includes a 35mm ferrite disk. The purpose of this disk is to increase the power received by the DC1967A-A/DC1967A-B receiver board. The 25mm ferrite disk that is shipped and attached to the DC1967A-A/DC1967A-B board is attached with double-sided tape, and is likely to break if removed. Laying the 35mm ferrite on top of the shipped 25mm ferrite disk will increase received power approximately 30%. Removing the 25mm ferrite disk and attaching the 35mm disk will increase received power approximately 20%. In both cases the minimum clearance distance will increase to approximately 3mm. Since the 25mm ferrite disk shipped on the DC1967A-A/DC1967A-B board is likely to break, exchanging disks can only be done once.

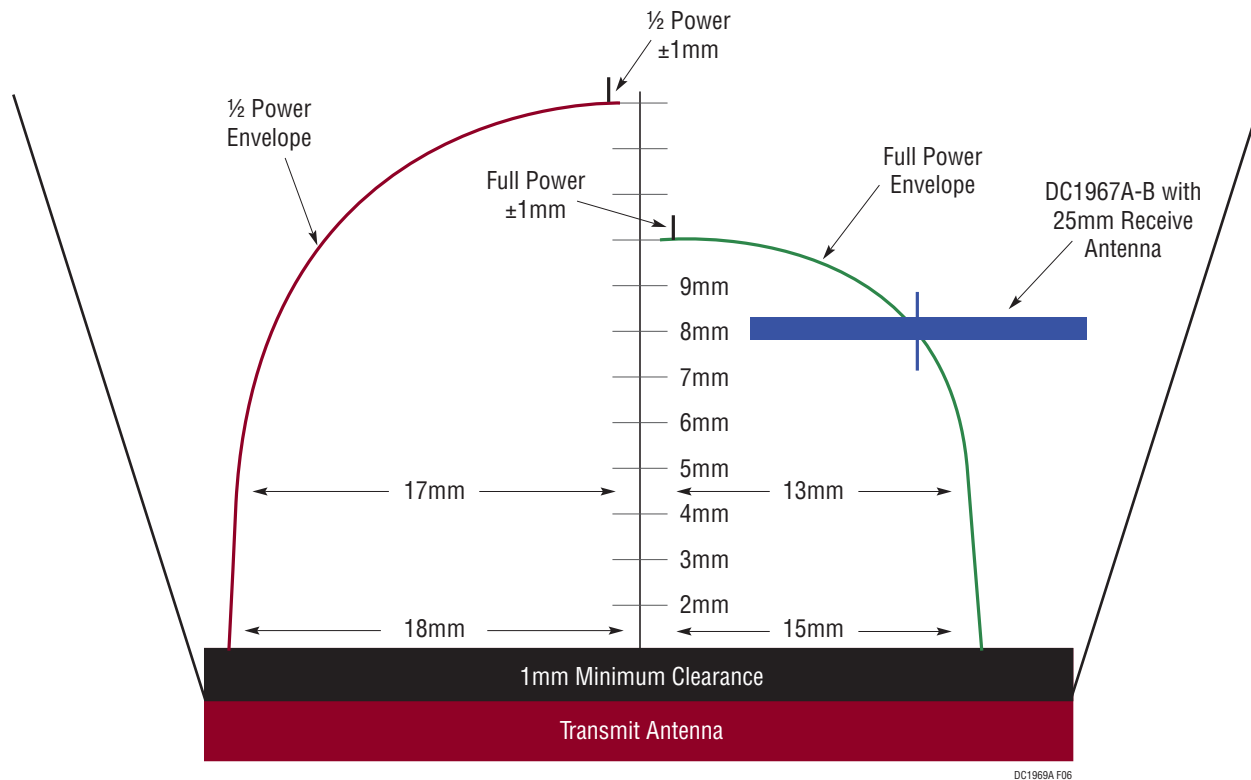

Figure 6. Power Transfer vs Axial Distance and Misalignment

THEORY OF OPERATION

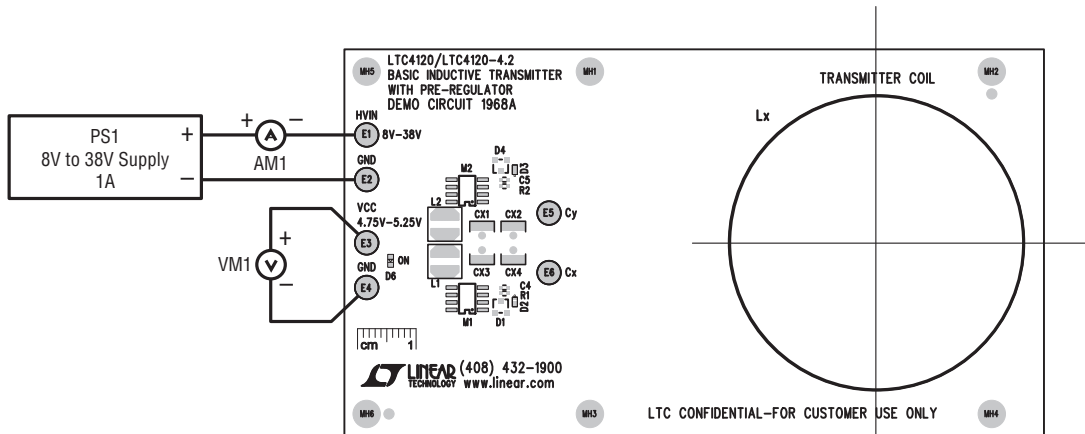

Figure 7a. Using High Voltage Input

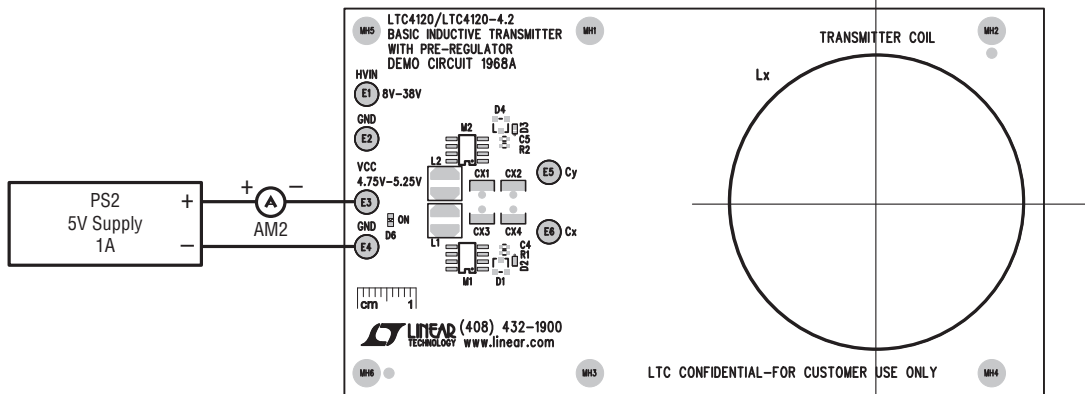

Figure 7b. Using the V_{CC} Input

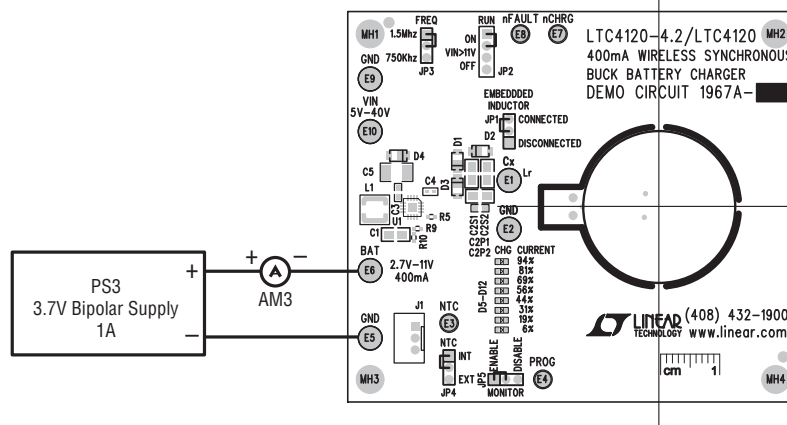

Figure 7c. Receive Board with Battery Emulator

Figure 7

Note: All connections from equipment should be Kelvin connected directly to the board pins which they are connected on this diagram and any input or output leads should be twisted pair.

THEORY OF OPERATION

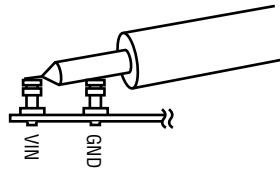

Figure 8. Measuring Input or Output Ripple

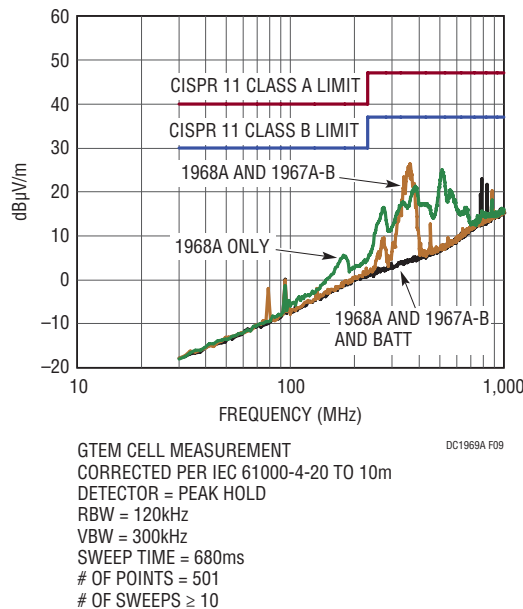

Figure 9. LTC4120 (DC1968A and DC1967A-B) Radiated Emissions

Radiated Emissions

Radiated emissions information was gathered using a gigahertz transverse electromagnetic (GTEM) cell. The GTEM cell dimensions were 0.2m × 0.2m × 0.15m. The data was normalized to a 10m semi-anechoic chamber (SAC) per IEC61000-4-20 using peak hold detection.

The limits shown on the graph are for CISPR 11 class A (yellow) and class B (red). The CISPR 11 limits are applicable to industrial commercial and medical equipment. The emissions detection method was peak hold of the square root of the sum of the emissions from each face, X, Y, Z, squared. As the emissions are always at least 6dB from the regulatory limits, the use of quasi-peak detection was not necessary. Data was gathered on a single representative system.

The blue line shape is data gathered from a DC1968A basic transmitter operating alone and powered at $V_{CC} = 5V$ from a bench supply. The yellow line shape is data gathered from a DC1968A basic transmitter powered at $V_{CC} = 5V$ from a bench supply, and energizing a DC1967A LTC4120 wireless power receive board with no battery. And the green line shape is data gathered from a DC1968A basic transmitter powered at $V_{CC} = 5V$ from a bench supply, and energizing a DC1967A LTC4120 wireless power receive board charging a Li-Ion battery at 400mA.

The LTC4120 wireless power system is intended to be a part of a complete end product. Only the complete end product needs to be FCC certified. The data presented here on the wireless power system is for end product design purposes only, not to obtain FCC certification.

PARTS LIST

ITEM	QTY	REFERENCE	PART DESCRIPTION	MANUFACTURER/PART NUMBER
DC1967A Required Circuit Components				
1	2	C2S1, C2P1	CAP, CHIP, C0G, 0.0047 μ F, \pm 5%, 50V, 0805	MURATA, GRM2165C1H472JA01D
2	1	C2P2	CAP, CHIP, C0G, 0.0018 μ F, \pm 5%, 50V, 0603	KEMET, C0603C182J5GAC7533
3	1	C2S2	CAP, CHIP, C0G, 0.022 μ F, \pm 5%, 50V, 0805	MURATA, GRM21B5C1H223JA01L
4	1	C1	CAP, CHIP, X5R, 10 μ F, \pm 20%, 16V, 0805	TDK, C2012X5R1C106K
5	1	C2	CAP, CHIP, X5R, 47 μ F, \pm 10%, 16V, 1210	MURATA, GRM32ER61C476KE15L
6	1	C3	CAP, CHIP, X7R, 0.01 μ F, \pm 10%, 50V, 0603	TDK, C1608X7R1H103K
7	1	C4	CAP, CHIP, X5R, 2.2 μ F, \pm 20%, 6.3V, 0402	MURATA, GRM155R60J225ME15D
8	1	C5	CAP, CHIP, X7S, 10 μ F, \pm 20%, 50V, 1210	TDK, C3225X7S1H106M
9	3	D1, D2, D3	DIODE, SCHOTTKY, 40V, 2A, PowerDI123	DIODES, DFSL240L
10	1	D4	DIODE, Zener, 39V, \pm 5%, 1W, PowerDI123	DIODES, DFLZ39
11	1	FB1	25mm Ferrite Bead	ADAMS MAGNETICS, B67410-A0223-X195
12	0	Lr	IND, EMBEDDED, 47 μ H, 43 turns	EMBEDDED
13	1	L1	IND, SMT, 15 μ H, 260m Ω , \pm 20%, 0.86A, 4mm \times 4mm	LPS4018-153ML
14	1	R1	RES, CHIP, 1.40M, \pm 1%, 1/16W, 0402	VISHAY, CRCW04021M40FKED
15	1	R2	RES, CHIP, 412k Ω , \pm 1%, 1/16W, 0402	VISHAY, CRCW0402412KFKED
16	2	R3, R7	RES, CHIP, 10k Ω , \pm 1%, 1/16W, 0402	VISHAY, CRCW040210K0FKED
17	1	R5	RES, CHIP, 3.01k Ω , \pm 1, 1/16W, 0402	VISHAY, CRCW04023K01FKED
18	2	R6, R8	RES, CHIP, 0 Ω JUMPER, 1/16W, 0402	VISHAY, CRCW04020000Z0ED
Additional Demo Board Circuit Components				
1	2	C7, C10	CAP, CHIP, X5R, 1 μ F, \pm 10%, 16V, 0402	TDK, C1005X5R1C105K
2	3	C6, C8, C9	CAP, CHIP, X7R, 0.01 μ F, \pm 10%, 25V, 0402	TDK, C1005X7R1E103K
3	8	D5, D6, D7, D8, D9, D10, D11, D12	DIODE, LED, GREEN, 0603	LITE-ON, LTST-C193KGKT-5A
4	1	R4	RES, CHIP, 2k Ω , \pm 5%, 1/16W, 0402	VISHAY, CRCW04022K00JNED
5	2	R11, R12	RES, CHIP, 100k Ω , \pm 5%, 1/16W, 0402	VISHAY, CRCW0402100KJNED
6	1	R13	RES, CHIP, 10k Ω , \pm 5%, 1/16W, 0402	VISHAY, CRCW040210K0JNED
7	2	R14, R35	RES, CHIP, 432 Ω , \pm 1%, 1/16W, 0402	VISHAY, CRCW0402432RFKED
8	2	R15, R33	RES, CHIP, 22.6k Ω , \pm 1%, 1/16W, 0402	VISHAY, CRCW040222K6FKED
9	1	R16	RES, CHIP, 34.8k Ω , \pm 1%, 1/16W, 0402	VISHAY, CRCW040234K8FKED
10	7	R17, R18, R19, R20, R21, R22, R23	RES, CHIP, 100k Ω , \pm 1%, 1/16W, 0402	VISHAY, CRCW0402100KFKED
11	1	R24	RES, CHIP, 49.9k Ω , \pm 1%, 1/16W, 0402	VISHAY, CRCW040249K9FKED
12	8	R25, R26, R27, R28, R29, R30, R31, R32	RES, CHIP, 1k Ω , \pm 5%, 1/16W, 0402	VISHAY, CRCW04021K00JNED
13	1	R34	RES, CHIP, 787k Ω , \pm 1%, 1/16W, 0402	VISHAY, CRCW0402787KFKED
14	2	U2, U3	Ultralow Power Quad Comparators with Reference, 5mm \times 4mm DFN-16	LINEAR TECH., LTC1445CDHD
Hardware For Demo Board Only				
1	6	E1, E2, E5, E6, E9, E10	TURRET, 0.091"	MILL-MAX, 2501-2-00-80-00-00-07-0
2	4	E3, E4, E7, E8	TURRET, 0.061"	MILL-MAX, 2308-2-00-80-00-00-07-0
3	0	J1-OPT	CONN, 3 Pin Polarized	HIROSE, DF3-3P-2DSA
4	4	JP1, JP3-JP5	HEADER, 3 Pin, SMT, 2mm	SAMTEC, TMM-103-01-L-S-SM
5	1	JP2	HEADER, 4 Pin, SMT, 2mm	SAMTEC, TMM-104-01-L-S-SM
6	5	JP1-JP5	SHUNT, 2mm	SAMTEC, 2SN-BK-G
7	4		CLEAR 0.085" \times 0.335" BUMPER	KEYSTONE, 784-C

DEMO MANUAL

DC1969A-A/DC1969A-B

PARTS LIST

ITEM	QTY	REFERENCE	PART DESCRIPTION	MANUFACTURER/PART NUMBER
8	15		15mm DOUBLE SIDED TAPE	3M, 34-8705-5578-5
9	4		STAND-OFF, NYLON, 0.375"	KEYSTONE, 8832

DC1967A-A Required Circuit Components

1	0	R9	NO LOAD. SMD 0402	
2	1	R10	RES, CHIP, 0Ω JUMPER, 1/16W, 0402	VISHAY, CRCW04020000Z0ED
3	1	U1	400mA Wireless Synchronous Buck Battery Charger, 3mm × 3mm QFN-16	LINEAR TECH., LTC4120EUD-4.2

DC1967A-B Required Circuit Components

1	1	R9	RES, CHIP, 1.40M, ±1%, 1/16W, 0402	VISHAY, CRCW04021M40FKED
2	1	R10	RES, CHIP, 1.05M, ±1%, 1/16W, 0402	VISHAY, CRCW04021M05FKED
3	1	U1	400mA Wireless Synchronous Buck Battery Charger, 3mm × 3mm QFN-16	LINEAR TECH., LTC4120EUD

DC1968A Required Circuit Components

1	1	CX1, CX2	CAP, CHIP, PPS, 0.15μF, ±2%, 50V, 6.0mm × 4.1mm	PANASONIC, ECHU1H154GX9
2	2	C4, C5	CAP, CHIP, X7R, 0.01μF, ±10%, 50V, 0402	MURATA, GRM155R71H103KA88D
3	1	C6	CAP, CHIP, X5R, 4.7μF, ±10%, 50V, 1206	MURATA, GRM31CR71H475KA12L
4	1	C7	CAP, CHIP, X5R, 0.068μF, ±10%, 50V, 0603	MURATA, GRM188R71H683K
5	1	C8	CAP, CHIP, C0G, 330pF, ±5%, 50V, 0402	TDK, C1005C0G1H331J
6	1	C9	CAP, CHIP, X7R, 0.47μF, ±10%, 25V, 0603	MURATA, GRM188R71E474K
7	1	C10	CAP, CHIP, X5R, 22μF, ±20%, 6.3V, 0805	TAIYO-YUDEN, JMK212BJ226MG
8	2	D1, D4	DIODE, ZENER, 16V, 350mW, SOT23	DIODES, BZX84C16
9	2	D2, D3	DIODE, SCHOTTKY, 40V, 1A, 2DSN	ON SEMICONDUCTOR, NSR10F40NXT5G
10	1	D5	DIODE, SCHOTTKY, 40V, 2A, PowerDI123	DIODES, DFLS240L
11	2	L1, L2	IND, SMT, 68μH, 0.41A, 0.40Ω, ±20%, 5mm × 5mm	TDK, VLCF5028T-680MR40-2
12	1	L3	IND, SMT, 4.7μH, 1.6A, 0.125Ω, ±20%, 4mm × 4mm	COILCRAFT, LPS4018-472M
13	1	Lx	TRANSMIT COIL	TDK, WT-505060-8K2-LT
14	2	M1, M2	MOSFET, SMT, N-CHANNEL, 60V, 11mΩ, SO8	VISHAY, Si4108DY-T1-GE3
15	1	M3	MOSFET, SMT, P-CHANNEL, -12V, 32mΩ, SOT23	VISHAY, Si2333DS
16	1	M4	MOSFET, SMT, N-CHANNEL, 60V, 7.5Ω, 115mA, SOT23	ON SEMI, 2N7002L
17	2	R1, R2	RES, CHIP, 100Ω, ±5%, 1/16W, 0402	VISHAY, CRCW0402100RJNED
18	2	R3, R8	RES, CHIP, 150kΩ, ±5%, 1/16W, 0402	VISHAY, CRCW0402150JNED
19	1	R4	RES, CHIP, 40.2kΩ, ±1%, 1/16W, 0402	VISHAY, CRCW040240K2FKED
20	1	R5	RES, CHIP, 20kΩ, ±1%, 1/16W, 0402	VISHAY, CRCW040220K0FKED
21	2	R6, R10	RES, CHIP, 100kΩ, ±1%, 1/16W, 0402	VISHAY, CRCW0402100KFKED
22	1	R7	RES, CHIP, 536kΩ, ±1%, 1/16W, 0402	VISHAY, CRCW0402536KFKED
23	1	U1	LT3480EDD, PMIC 38V, 2A, 2.4MHz Step-Down Switching Regulator with 70μA Quiescent Current	LINEAR TECH., LT3480EDD

Additional Demo Board Circuit Components

1	0	CX3-OPT, CX4-OPT	CAP, PPS, 0.15μF, ±2.5%, 63Vac, MKS02	WIMA, MKS0D031500D00JSSD
2	1	D6	LED, GREEN, 0603	LITE-ON, LTST-C190KGKT
3	1	R9	RES, CHIP, 1kΩ, ±5%, 1/16W, 0402	VISHAY, CRCW04021K00JNED

Hardware For Demo Board Only

1	6	E1-E6	TURRET, 0.09 DIA	MILL-MAX, 2501-2-00-80-00-00-07-0
2	40		40mm DOUBLE SIDED TAPE	3M, 34-8705-5578-5
3	4		STAND-OFF, NYLON, 0.375"	KEYSTONE, 8832

SCHEMATIC DIAGRAM

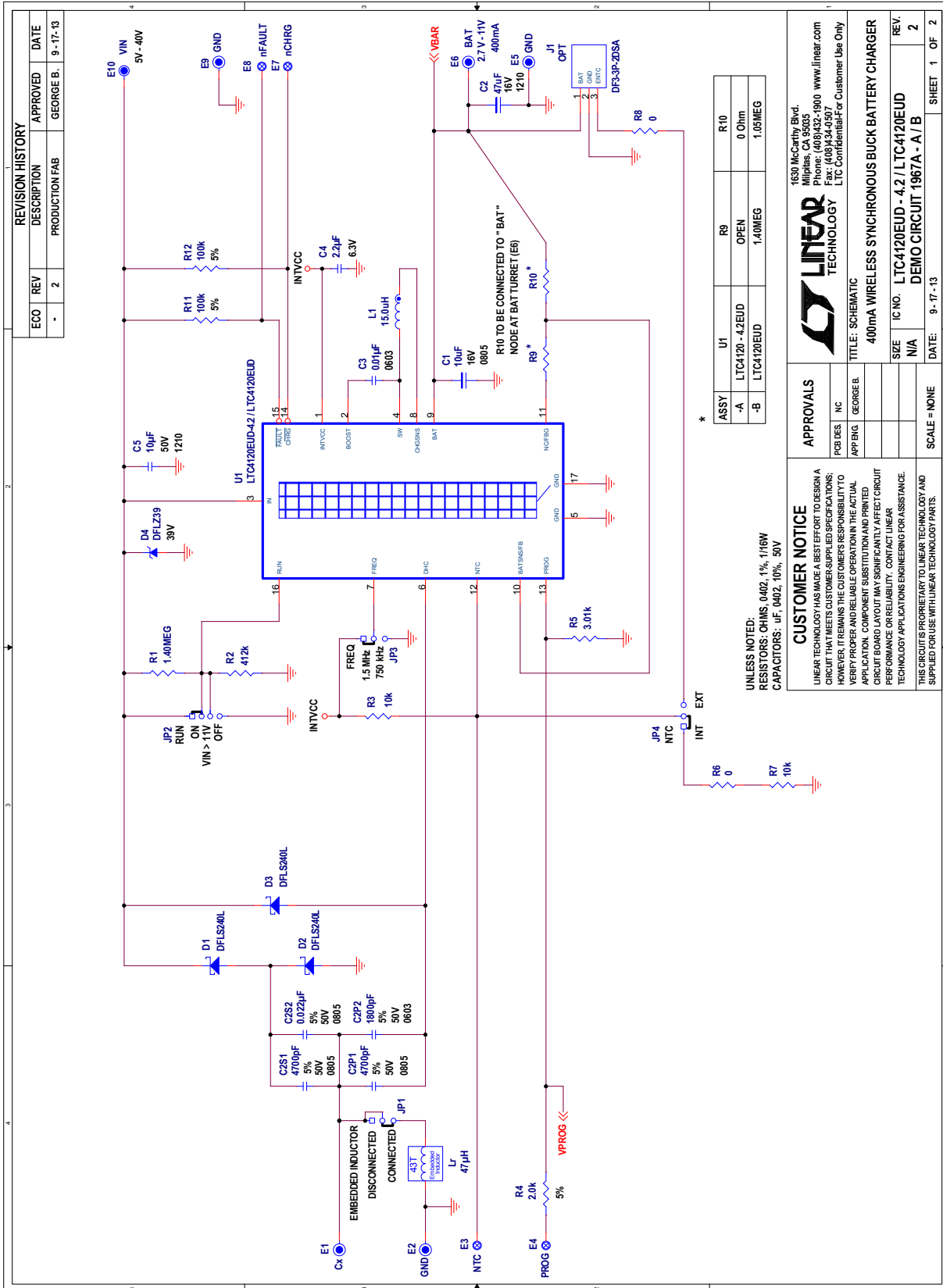
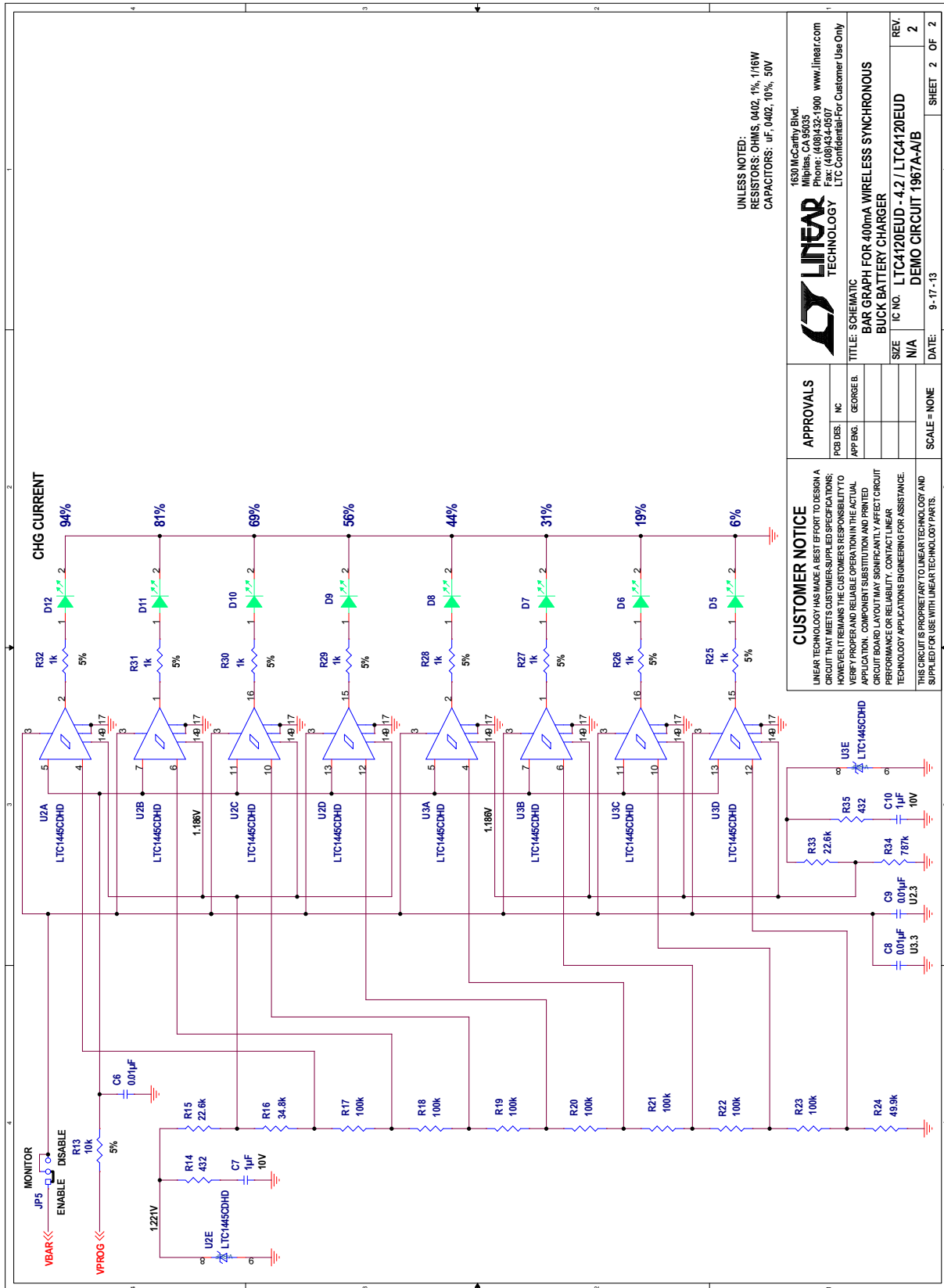

Figure 10. DC1969A Circuit Schematic

DEMO MANUAL

DC1969A-A/DC1969A-B

SCHEMATIC DIAGRAM



UNLESS NOTED:
RESISTORS: OHMS, 0A02, 1%, 1/16W
CAPACITORS: uF, 0A02, 10%, 50V

1630 McCarty Blvd.
Milpitas, CA 95035
Phone: 408.255.0900 www.linear.com
Fax: 408.255.0507
LTC Confidential-For Customer Use Only

LINEAR TECHNOLOGY

TITLE: SCHEMATIC
BAR GRAPH FOR 400mA WIRELESS SYNCHRONOUS BUCK BATTERY CHARGER

APPROVALS
PDR DES: NC
APP ENG: GEORGE B.

CUSTOMER NOTICE
LINEAR TECHNOLOGY HAS MADE A BEST EFFORT TO DESIGN A CIRCUIT THAT MEETS CUSTOMER SUPPLIED SPECIFICATIONS. HOWEVER, IT REMAINS THE CUSTOMER'S RESPONSIBILITY TO VERIFY PROPER AND RELIABLE OPERATION IN THE ACTUAL APPLICATION. COMPONENT SUBSTITUTION AND PRINTED CIRCUIT BOARD LAYOUT MAY SIGNIFICANTLY AFFECT CIRCUIT PERFORMANCE OR RELIABILITY. CONTACT LINEAR TECHNOLOGY APPLICATIONS ENGINEERING FOR ASSISTANCE.

THIS CIRCUIT IS PROPRIETARY TO LINEAR TECHNOLOGY AND SUPPLIED FOR USE WITH LINEAR TECHNOLOGY PARTS.

SIZE: N/A
IC NO: LTC1420EUD - 4.2 / LTC1420EUD
REV: 2

DATE: 9-17-13
SCALE: NONE
SHEET 2 OF 2

Figure 11. DC1969A Circuit Schematic

SCHEMATIC DIAGRAM

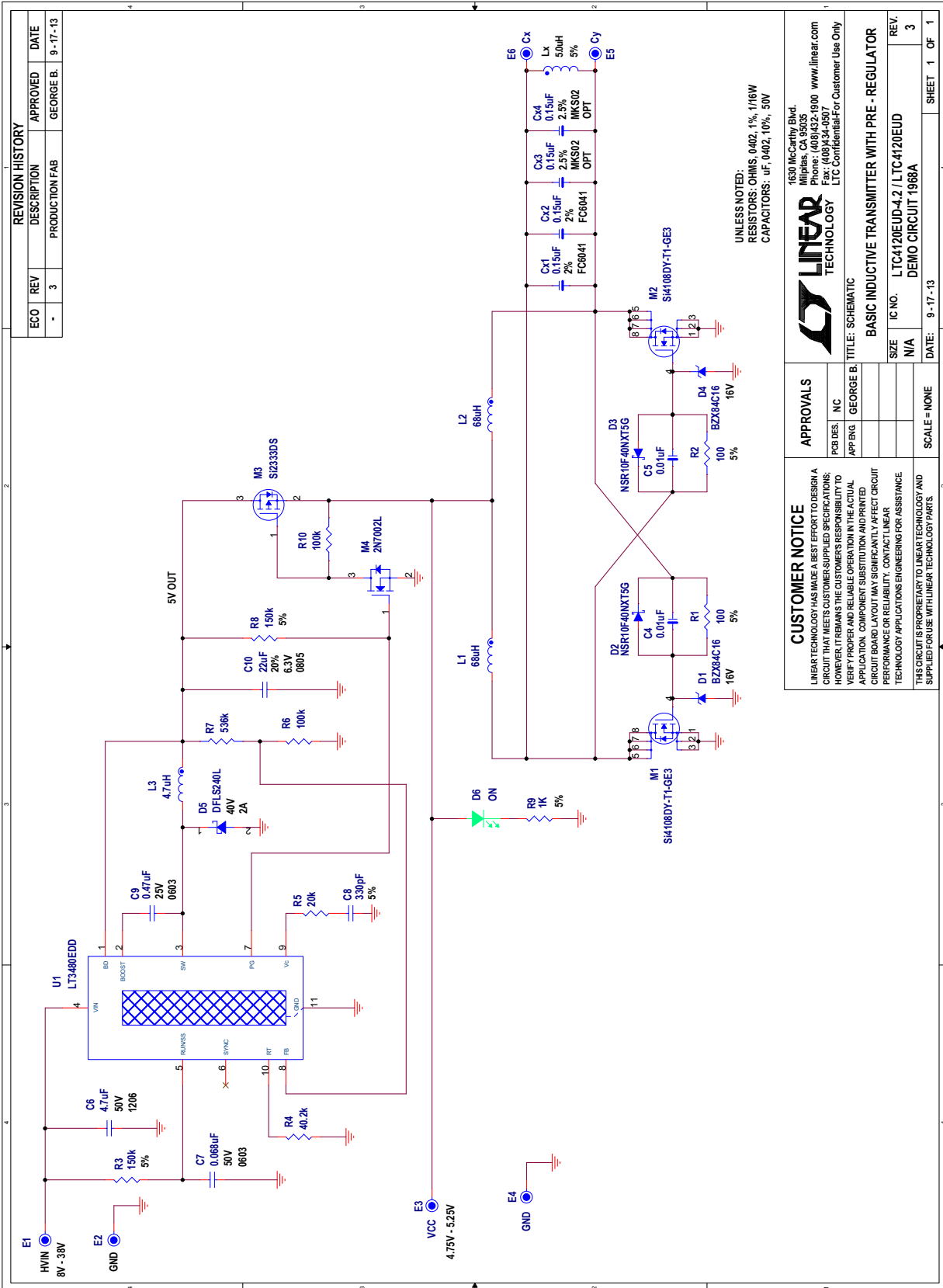

Figure 12. DC1969A Circuit Schematic

DEMO MANUAL

DC1969A-A/DC1969A-B

DEMONSTRATION BOARD IMPORTANT NOTICE

Linear Technology Corporation (LTC) provides the enclosed product(s) under the following **AS IS** conditions:

This demonstration board (DEMO BOARD) kit being sold or provided by Linear Technology is intended for use for **ENGINEERING DEVELOPMENT OR EVALUATION PURPOSES ONLY** and is not provided by LTC for commercial use. As such, the DEMO BOARD herein may not be complete in terms of required design-, marketing-, and/or manufacturing-related protective considerations, including but not limited to product safety measures typically found in finished commercial goods. As a prototype, this product does not fall within the scope of the European Union directive on electromagnetic compatibility and therefore may or may not meet the technical requirements of the directive, or other regulations.

If this evaluation kit does not meet the specifications recited in the DEMO BOARD manual the kit may be returned within 30 days from the date of delivery for a full refund. **THE FOREGOING WARRANTY IS THE EXCLUSIVE WARRANTY MADE BY THE SELLER TO BUYER AND IS IN LIEU OF ALL OTHER WARRANTIES, EXPRESSED, IMPLIED, OR STATUTORY, INCLUDING ANY WARRANTY OF MERCHANTABILITY OR FITNESS FOR ANY PARTICULAR PURPOSE. EXCEPT TO THE EXTENT OF THIS INDEMNITY, NEITHER PARTY SHALL BE LIABLE TO THE OTHER FOR ANY INDIRECT, SPECIAL, INCIDENTAL, OR CONSEQUENTIAL DAMAGES.**

The user assumes all responsibility and liability for proper and safe handling of the goods. Further, the user releases LTC from all claims arising from the handling or use of the goods. Due to the open construction of the product, it is the user's responsibility to take any and all appropriate precautions with regard to electrostatic discharge. Also be aware that the products herein may not be regulatory compliant or agency certified (FCC, UL, CE, etc.).

No License is granted under any patent right or other intellectual property whatsoever. **LTC assumes no liability for applications assistance, customer product design, software performance, or infringement of patents or any other intellectual property rights of any kind.**

LTC currently services a variety of customers for products around the world, and therefore this transaction **is not exclusive**.

Please read the DEMO BOARD manual prior to handling the product. Persons handling this product must have electronics training and observe good laboratory practice standards. **Common sense is encouraged.**

This notice contains important safety information about temperatures and voltages. For further safety concerns, please contact a LTC application engineer.

Mailing Address:

Linear Technology
1630 McCarthy Blvd.
Milpitas, CA 95035

Copyright © 2004, Linear Technology Corporation