

## IRIS-SCREW

~5° real spot beam with holder optimized for CREE XP-E. Assembly with screws.

### TECHNICAL SPECIFICATIONS:

Dimensions	Ø 38.0 mm
Height	26.9 mm
Fastening	glue, pin, screw
Colour	black
Box size	
Box weight	0 kg
Quantity in Box	360 pcs
ROHS compliant	yes ⓘ



### MATERIAL SPECIFICATIONS:

Component	Type	Material	Colour
IRIS	Lens	PMMA	clear
IRIS-XP-HLD	Holder	PC	black

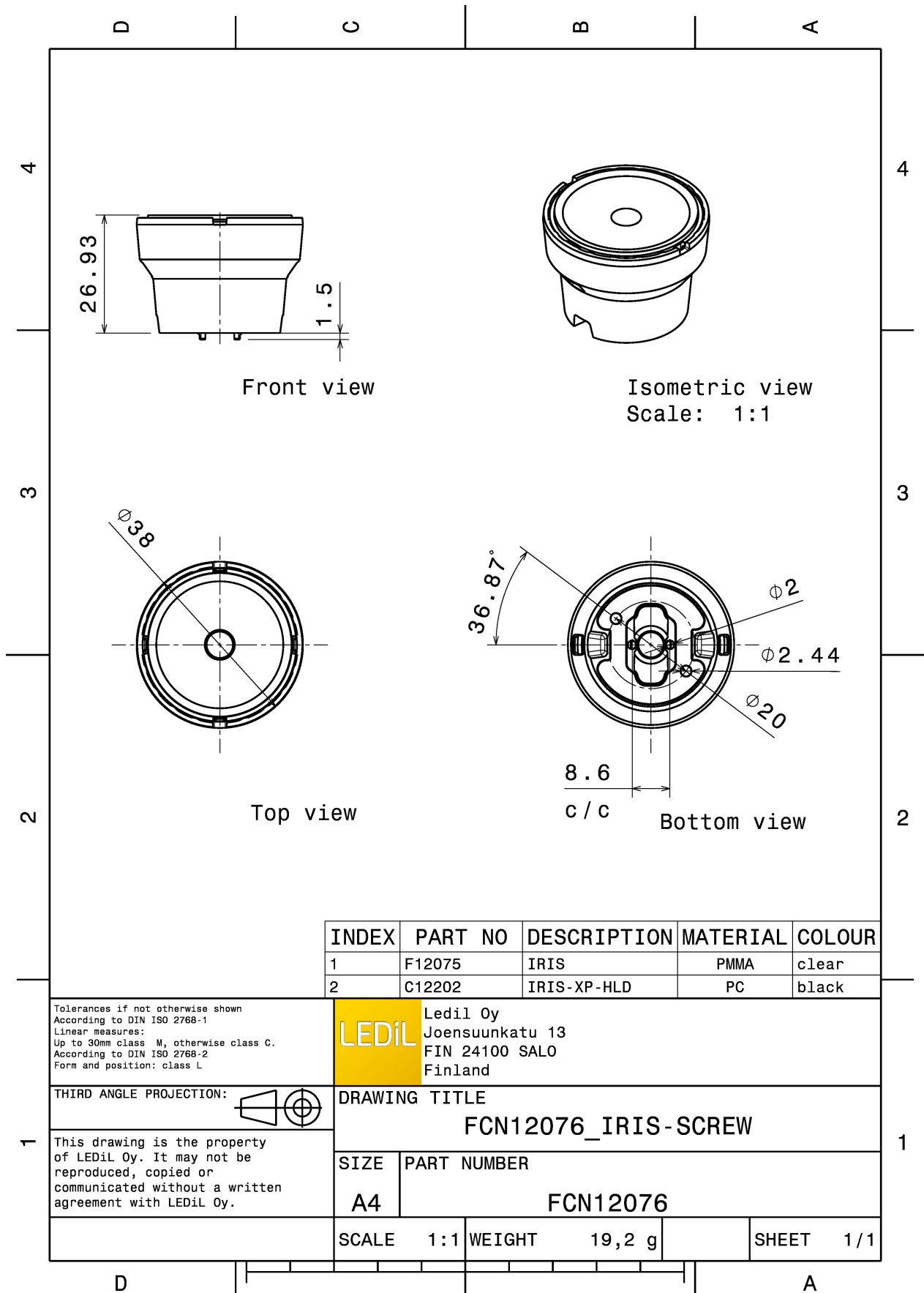

#### PHOTOMETRIC DATA (MEASURED):

**CREE** 

LED XHP35 HI  
FWHM 7.6°  
Efficiency 90 %  
Peak intensity 35.900 cd/lm  
Required components:

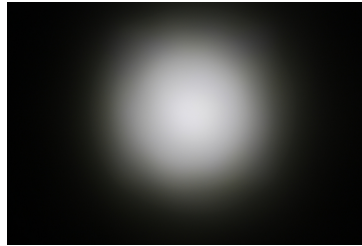

**CREE** 

LED XP-E  
FWHM 4.0°  
Efficiency 93 %  
Peak intensity 87.400 cd/lm  
Required components:

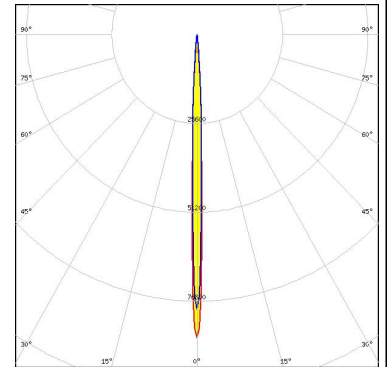

**CREE** 

LED XP-G  
FWHM 5.0°  
Efficiency 93 %  
Peak intensity 52.000 cd/lm  
Required components:

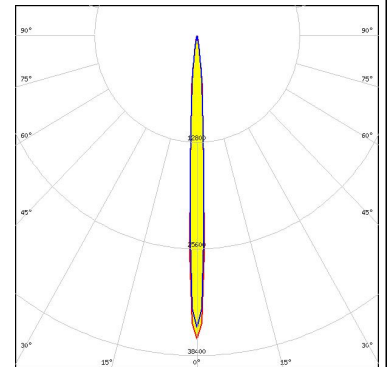
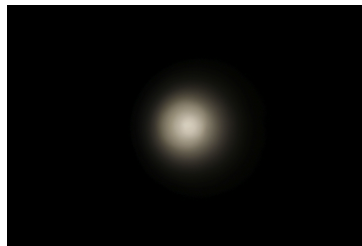

**CREE** 

LED XP-L  
FWHM 8.5°  
Efficiency 93 %  
Peak intensity 22.200 cd/lm  
Required components:

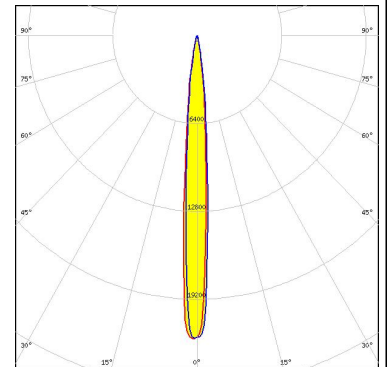

#### PHOTOMETRIC DATA (MEASURED):

##### LUMILEDS

LED LUXEON Rebel  
 FWHM 5.0°  
 Efficiency 93 %  
 Peak intensity 75.600 cd/lm  
 Required components:

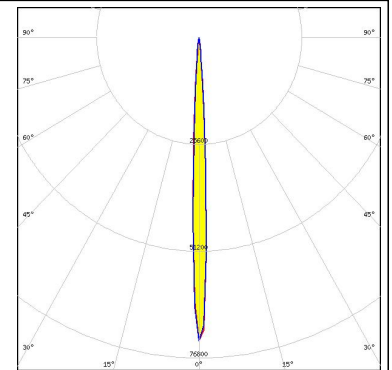

##### LUMILEDS

LED LUXEON Rebel ES  
 FWHM 7.0°  
 Efficiency 93 %  
 Peak intensity 38.500 cd/lm  
 Required components:

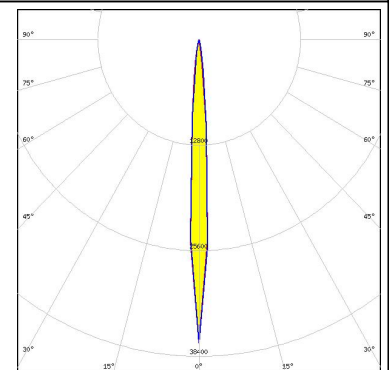

##### LUMILEDS

LED LUXEON V  
 FWHM 9.0°  
 Efficiency 92 %  
 Peak intensity 20.600 cd/lm  
 Required components:

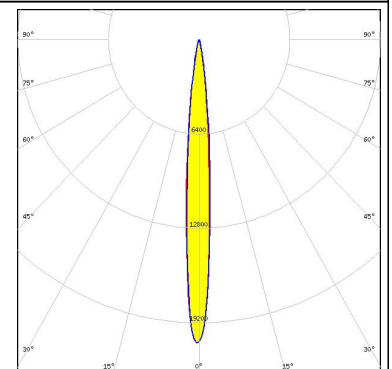



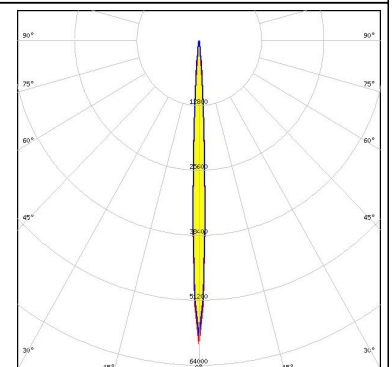

##### NICHIA

LED NCSxx19A  
 FWHM 5.0°  
 Efficiency %  
 Peak intensity cd/lm  
 Required components:

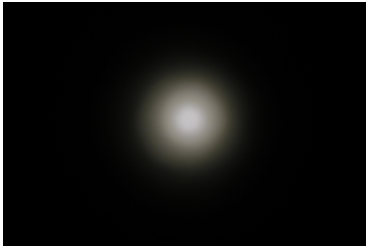
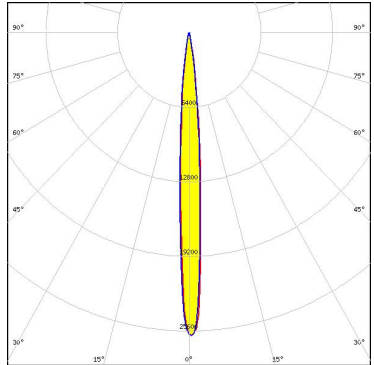

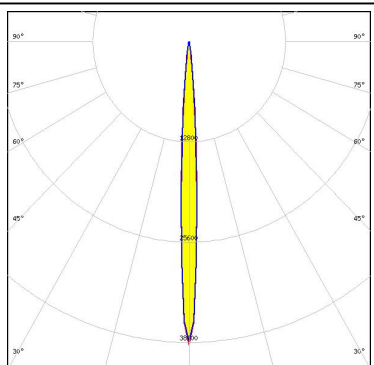
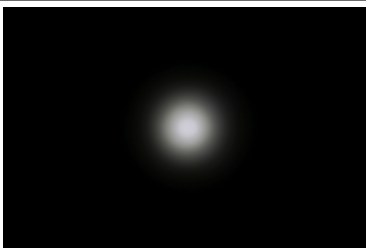
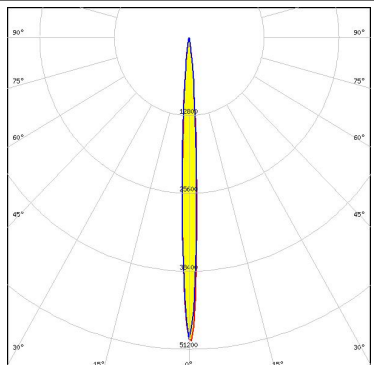
#### PHOTOMETRIC DATA (MEASURED):

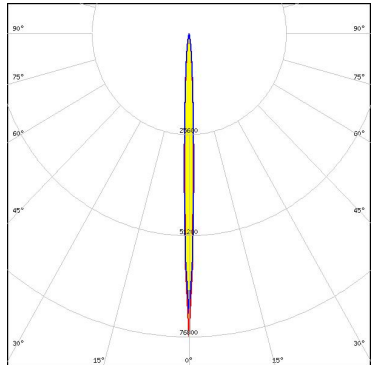
<p><b>NICHIA</b></p> <p>LED NVSW3x9A            FWHM 8.0°            Efficiency 90 %            Peak intensity 26.100 cd/lm            Required components:</p>		
<p><b>NICHIA</b></p> <p>LED NVSxx19A            FWHM 6.0°            Efficiency 93 %            Peak intensity 38.700 cd/lm            Required components:</p>		
<p><b>OSRAM</b>  <small>Opto Semiconductors</small></p> <p>LED Oslon Square Gen3            FWHM 6.0°            Efficiency 94 %            Peak intensity 49.900 cd/lm            Required components:</p>		
<p><b>OSRAM</b>  <small>Opto Semiconductors</small></p> <p>LED Oslon SSL 150            FWHM 4.0°            Efficiency 93 %            Peak intensity 76.800 cd/lm            Required components:</p>		

#### PHOTOMETRIC DATA (MEASURED):

**OSRAM**  
Opto Semiconductors

LED            Oslon SSL 80  
FWHM        4.0°  
Efficiency    90 %  
Peak intensity 89.000 cd/lm  
Required components:

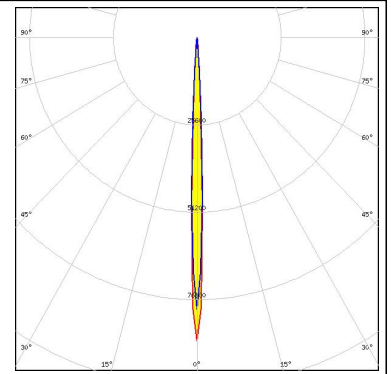

#### PHOTOMETRIC DATA (SIMULATED):



LED XP-E2  
 FWHM 5.9°  
 Efficiency 94 %  
 Peak intensity 56.600 cd/lm  
 Required components:

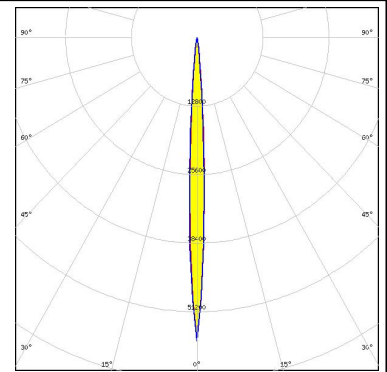

LED XP-G2  
 FWHM 6.7°  
 Efficiency 94 %  
 Peak intensity 44.300 cd/lm  
 Required components:

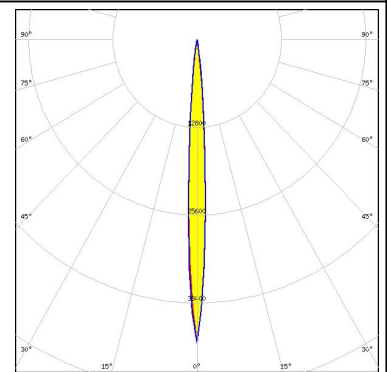

LED XP-G3  
 FWHM 7.5°  
 Efficiency 91 %  
 Peak intensity 29.600 cd/lm  
 Required components:

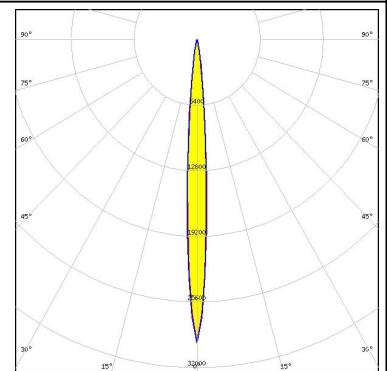

LED XQ-E  
 FWHM 5.0°  
 Efficiency 93 %  
 Peak intensity 80.000 cd/lm  
 Required components:

#### PHOTOMETRIC DATA (SIMULATED):

**CREE** 

LED XQ-E  
FWHM 5.5°  
Efficiency 94 %  
Peak intensity 74.200 cd/lm  
Required components:

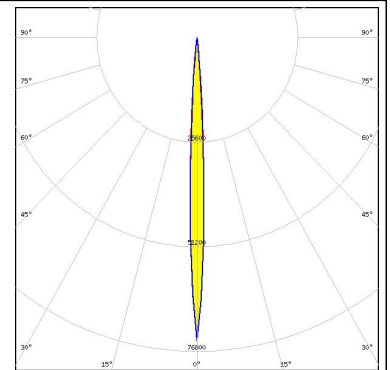

**OSRAM**  
Opto Semiconductors

LED OSCONIQ P 3737 (3W version)  
FWHM 9.0°  
Efficiency 94 %  
Peak intensity 25.500 cd/lm  
Required components:

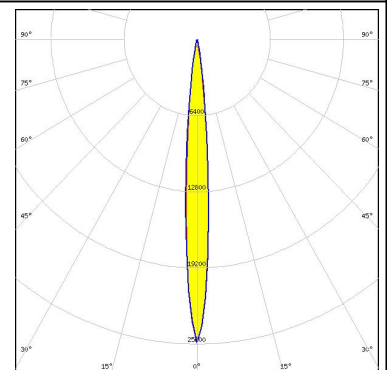

**SAMSUNG**

LED LH351B  
FWHM 7.4°  
Efficiency 94 %  
Peak intensity 33.850 cd/lm  
Required components:

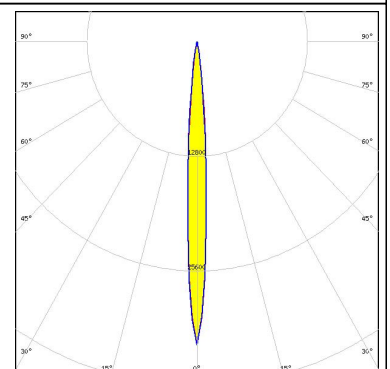

**SAMSUNG**

LED LH351D  
FWHM 9.2°  
Efficiency 90 %  
Peak intensity 20.620 cd/lm  
Required components:

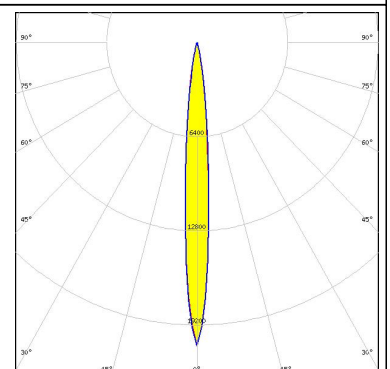



#### PHOTOMETRIC DATA (SIMULATED):

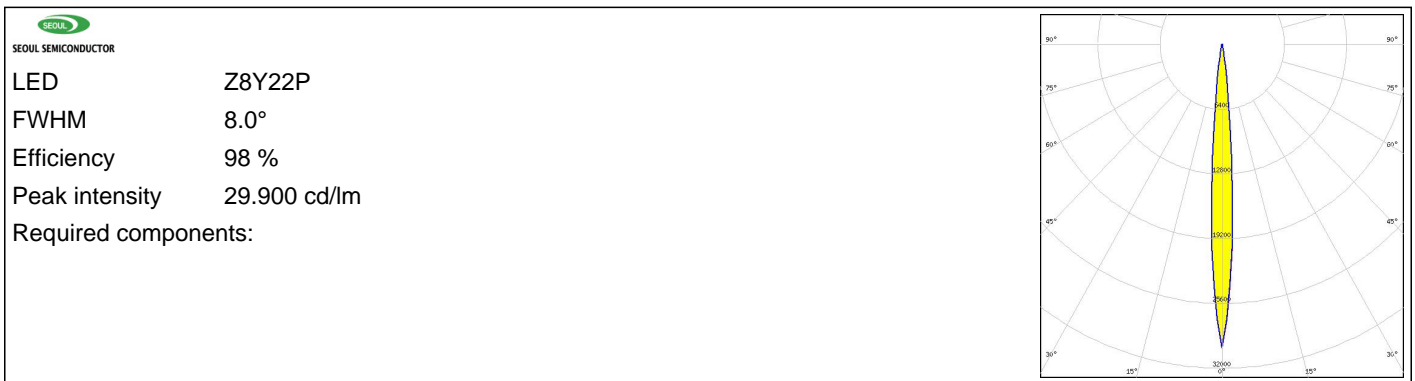

#### GENERAL INFORMATION:

NOTE: The typical beam angle will be changed by different color, chip size and chip position tolerance. The typical total beam angle is the full angle measured where the luminous intensity is half of the peak value.

#### MATERIALS:

As part of our continuous research and improvement processes, and to ensure the best possible quality and availability of our products, LEDiL reserves the right to change material grades without notice.

#### PRODUCT DATA USER AGREEMENT AND DISCLAIMER:

The measured data in the provided downloadable LEDiL Product Datasheets and Mechanical 2D-Drawings is rounded and provided as reference for planning. LEDiL Oy's optical specifications have been verified by conducting performance testing of the products in accordance with the company's quality system. The reported data are averaged results of multiple measurements with typical variation. LEDiL Oy reserves the right to without prior notification make changes and improvements to its products.

LEDiL Oy assumes neither warranty, nor guarantee nor any other liability of any kind for the contents and correctness of the provided data. The provided data has been generated with highest diligence but the provided data may in reality not represent the complete possible variation range of all intrinsic parameters. Therefore, in certain cases a deviation from the provided data could occur.

LEDiL Oy reserves the right to undertake technical changes of its products without further notification which could lead to changes in the provided data. LEDiL Oy assumes no liability of any kind for the possible deviation from any provided data or any other damage resulting from the usage of the provided data.

The user agrees to this disclaimer and user agreement with the download or usage of the provided files.

#### LEDiL Oy

Joensuunkatu 13  
FI-24240 SALO  
Finland

#### LEDiL Inc.

228 West Page Street  
Suite D  
Sycamore IL 60178  
USA

#### Local sales and technical support

[www.ledil.com/  
where\\_to\\_buy](http://www.ledil.com/where_to_buy)

#### Shipping locations

Salo, Finland  
Hong Kong, China

#### Distribution Partners

[www.ledil.com/  
where\\_to\\_buy](http://www.ledil.com/where_to_buy)