

## 4-line ESD protection for high speed lines

Datasheet – production data

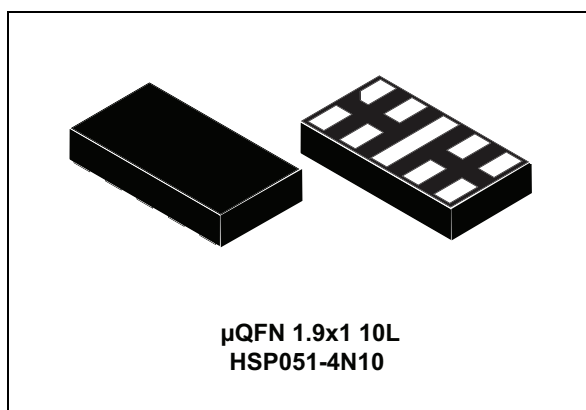
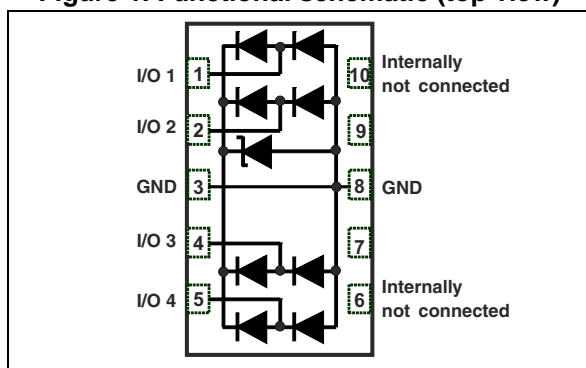

Figure 1. Functional schematic (top view)



### Features

- Flow-through routing to keep signal integrity
- Ultralarge bandwidth: 10 GHz
- Ultralow capacitance:
  - 0.2 pF (I/O to I/O)
  - 0.35 pF (I/O to GND)
- Very Low dynamic resistance: 0.48  $\Omega$
- 100  $\Omega$  differential impedance
- Low leakage current: 100 nA at 25  $^{\circ}$ C
- Extended operating junction temperature range: -40  $^{\circ}$ C to 150  $^{\circ}$ C
- RoHS compliant

### Benefits

- High ESD protection level
- High integration
- Suitable for high density boards

### Complies with following standards

- MIL-STD 883G Method 3015-7 Class 3B:
  - 8 kV
- IEC 61000-4-2 level 4:
  - 8 kV (contact discharge)
  - 15 kV (air discharge)

### Applications

The HSP051-4N10 is designed to protect against electrostatic discharge on sub micron technology circuits driving:

- HDMI 1.4 and 2.0
- Digital video Interface
- Display port
- USB 3.0 and 3.1
- Serial ATA

### Description

The HSP051-4N10 is a 4-channel ESD array with a rail to rail architecture designed specifically for the protection of high speed differential lines.

The ultralow variation of the capacitance ensures very low influence on signal-skew. The large bandwidth make it compatible with HDMI 2.0 4K/2K (=5.94 Gbps) and USB 3.1 (=10 Gbps)

The device is packaged in  $\mu$ QFN 1.9 mm x 1 mm with a 400  $\mu$ m pitch.

# 1 Characteristics

**Table 1. Absolute maximum ratings  $T_{amb} = 25\text{ }^{\circ}\text{C}$**

Symbol	Parameter		Value	Unit
$V_{PP}$	Peak pulse voltage	IEC 61000-4-2 contact discharge IEC 61000-4-2 air discharge	8 25	kV
$T_j$	Operating junction temperature range		-40 to +150	$^{\circ}\text{C}$
$T_{stg}$	Storage temperature range		-65 to +150	$^{\circ}\text{C}$
$T_L$	Maximum lead temperature for soldering during 10 s		260	$^{\circ}\text{C}$

**Table 2. Electrical characteristics  $T_{amb} = 25\text{ }^{\circ}\text{C}$**

Symbol	Test conditions		Min.	Typ.	Max.	Unit
$V_{BR}$	$I_R = 1\text{ mA}$		4.5	5.8		V
$I_{RM}$	$V_{RM} = 3.6\text{ V}$			10	100	nA
$V_{CL}$	$I_{PP} = 1\text{ A}$ , 8/20 $\mu\text{s}$				10	V
$V_{CL}$	IEC 61000-4-2, +8 kV contact ( $I_{PP} = 16\text{ A}$ ), measured at 30 ns			13		V
$R_d$	Dynamic resistance, pulse duration 100 ns	I/O to GND		0.48		$\Omega$
		GND to I/O		0.96		
$C_{I/O - I/O}$	$V_{I/O} = 0\text{ V}$ , $F = 200\text{ MHz}$ to 9 GHz			0.2	0.3	pF
$C_{I/O - GND}$	$V_{I/O} = 0\text{ V}$	$F = 200\text{ MHz}$ to 2.5 GHz		0.4	0.55	pF
		$F = 2.5\text{ GHz}$ to 9 GHz		0.35	0.45	pF
$f_C$	-3dB			10		GHz
$Z_{diff}$	Time domain reflectometry: $t_r = 200\text{ ps}$ (10 - 90%), $Z_0 = 100\ \Omega$		85	100	115	$\Omega$

**Figure 2. Leakage current versus junction temperature (typical values)**

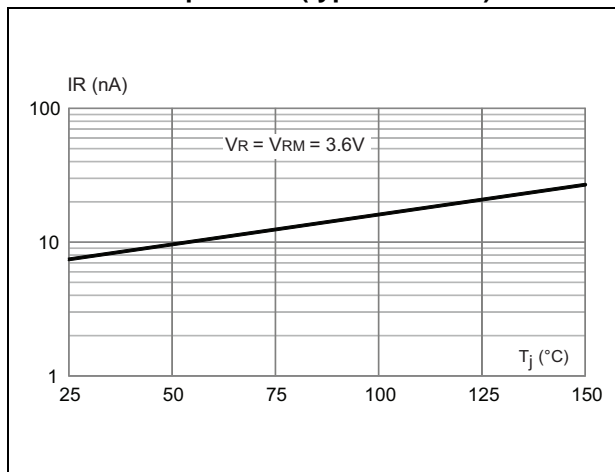

**Figure 3. S21 attenuation measurement**

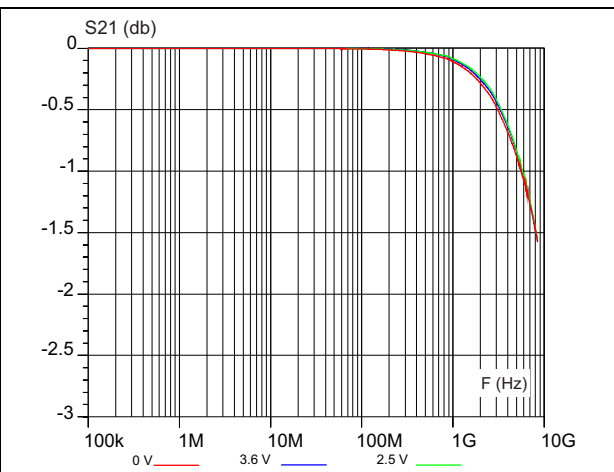
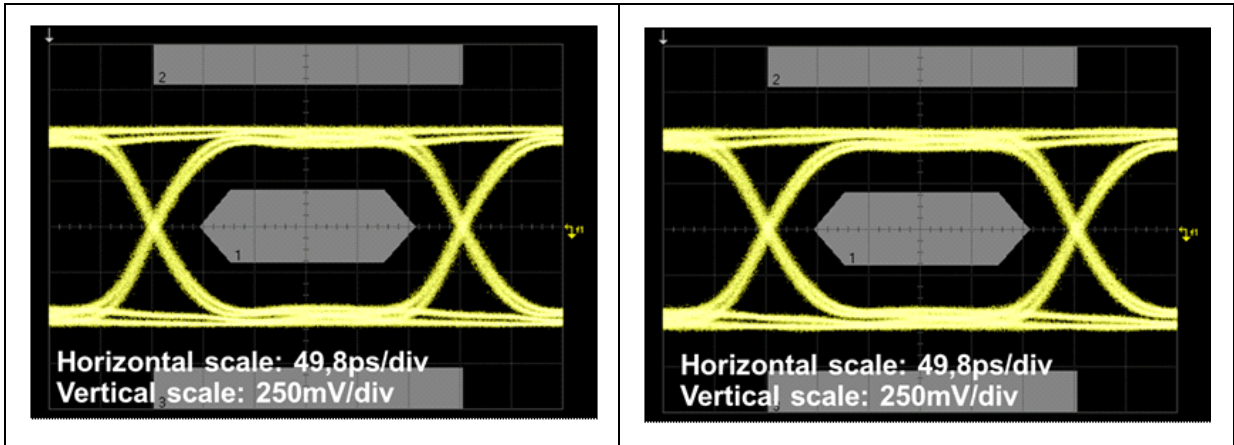

Figure 4. Eye diagram - HDMI mask at 3.4 Gbps per channel (without HSP051-4N10)<sup>(1)</sup>

Figure 5. Eye diagram - HDMI mask at 3.4 Gbps per channel<sup>(1)</sup> (with HSP051-4N10)



1. HDMI specification conditions. This information can be provided for other applications. Please contact your local ST office.

Figure 6. Eye diagram - HDMI 2.0 mask at 5.94 Gbps per channel (without HSP051-4N10)

Figure 7. Eye diagram - HDMI 2.0 mask at 5.94 Gbps per channel (with HSP051-4N10)

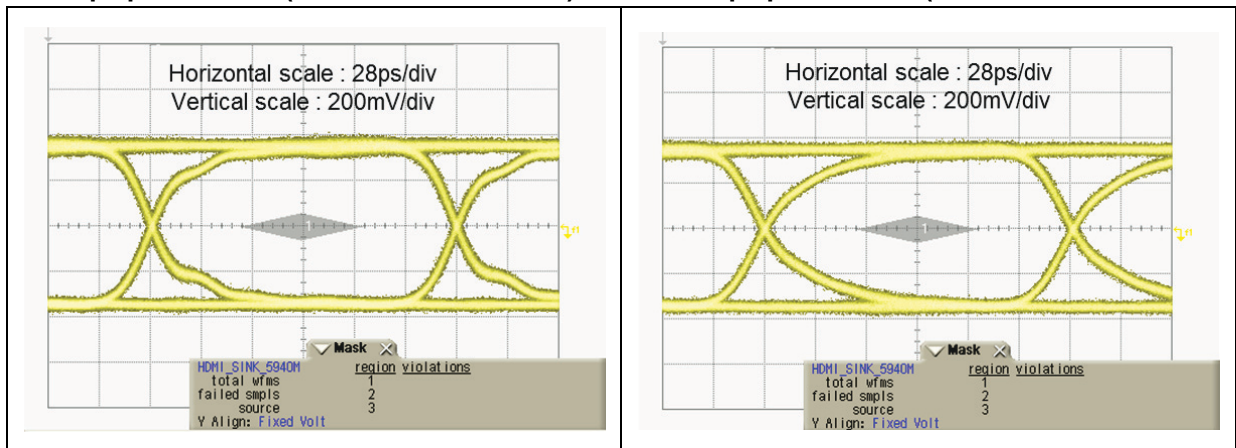

Figure 8. Eye diagram - USB 3.0 mask at 5.0 Gbps per channel (without HSP051-4N10)

Figure 9. Eye diagram - USB 3.0 mask at 5.0 Gbps per channel (with HSP051-4N10)

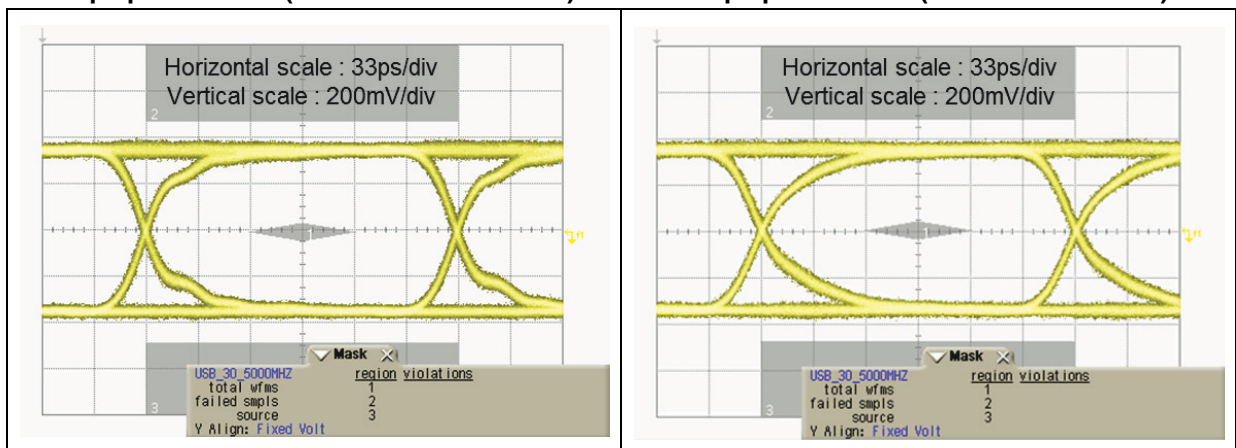

Figure 10. Eye diagram - USB 3.1 mask at 10.0 Gbps per channel (without HSP051-4N10)

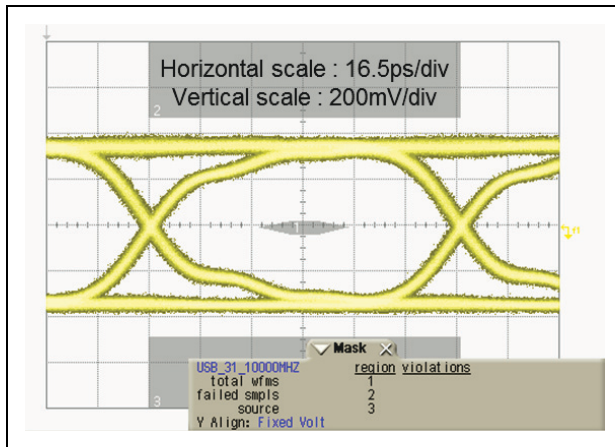

Figure 11. Eye diagram - USB 3.1 mask at 10.0 Gbps per channel (with HSP051-4N10)

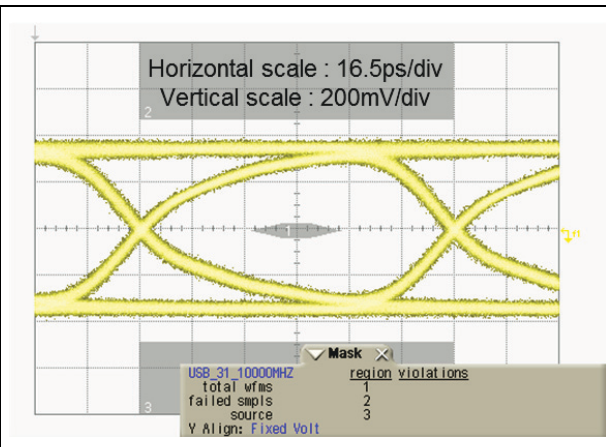

Figure 12. ESD response to IEC 61000-4-2 (+8 kV contact discharge)

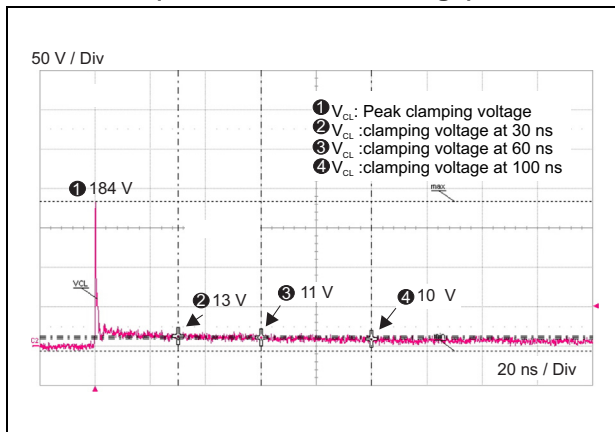

Figure 13. ESD response to IEC 61000-4-2 (-8 kV contact discharge)

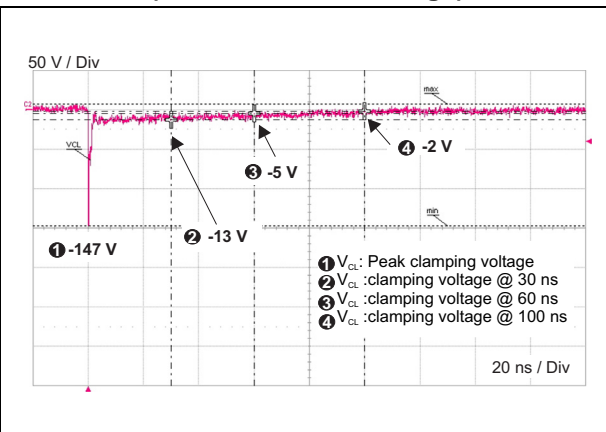

Figure 14. TLP measurement (pulse duration 100 ns)

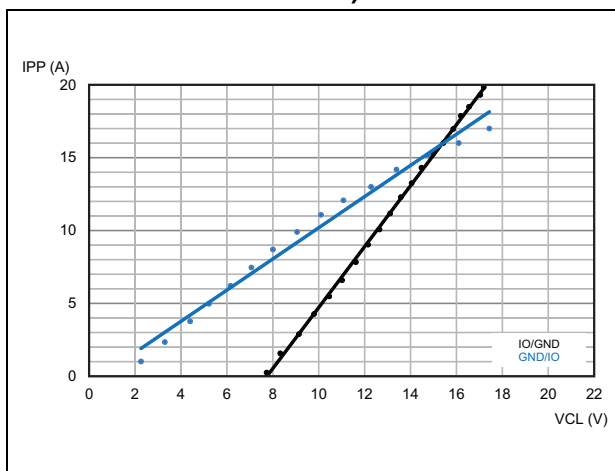
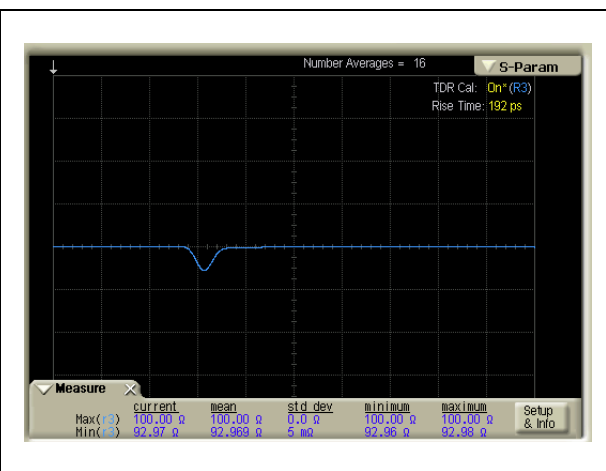

Figure 15. TDR measurement



## 2 Package information

- Epoxy meets UL94, V0
- Lead-free packages

In order to meet environmental requirements, ST offers these devices in different grades of ECOPACK® packages, depending on their level of environmental compliance. ECOPACK® specifications, grade definitions and product status are available at: [www.st.com](http://www.st.com). ECOPACK® is an ST trademark.

Figure 16.  $\mu$ QFN 1.9x1 10L dimension definitions

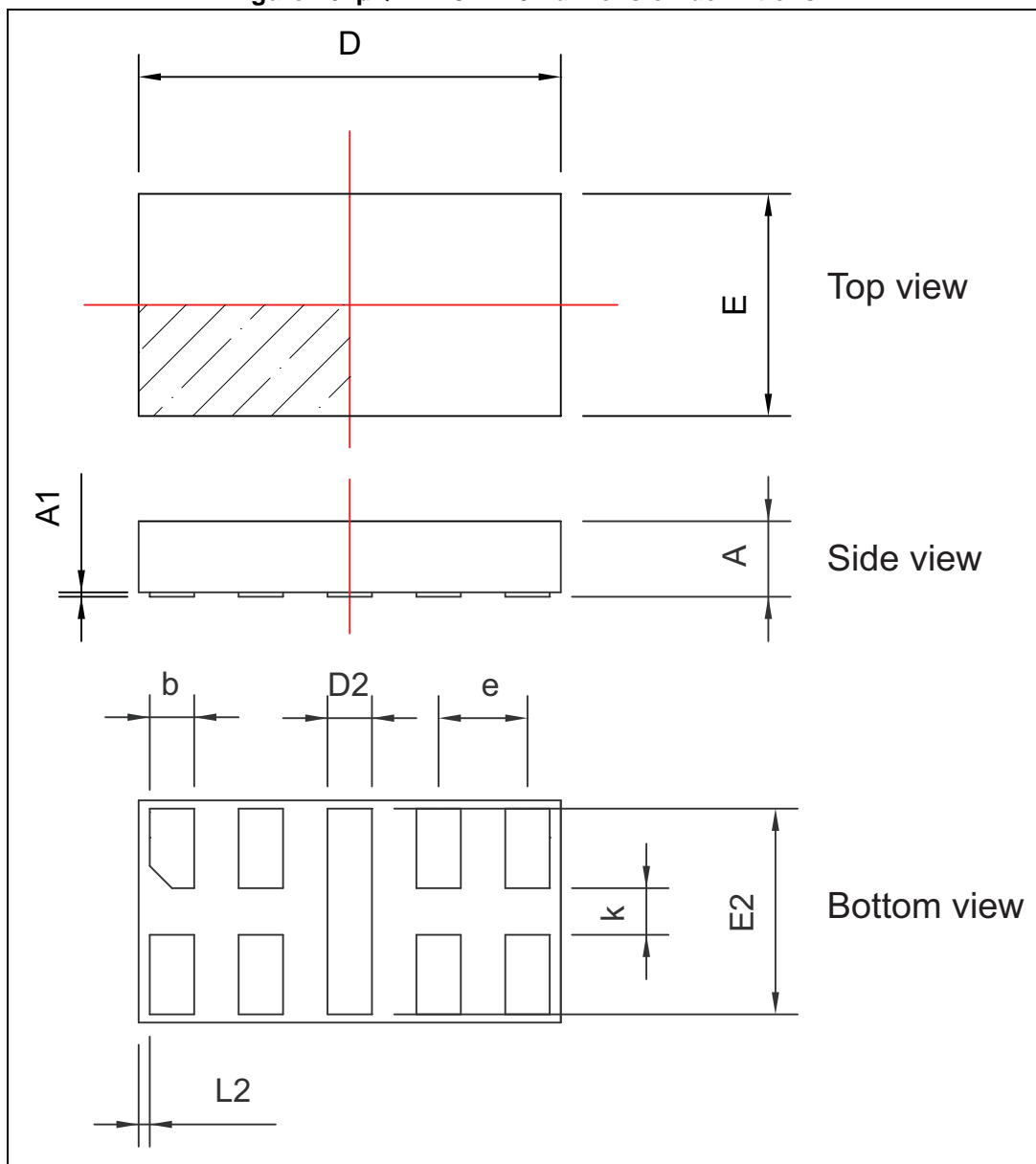

Table 3.  $\mu$ QFN 1.9x1 10L dimension values

Ref.	Dimensions		
	Millimeters		
	Min.	Typ.	Max.
A	0.29	0.32	0.35
A1	0.00	0.02	0.05
b	0.15	0.20	0.25
D	1.85	1.90	1.95
D2	0.15	0.20	0.25
E	0.95	1.00	1.05
E2	0.88	0.93	0.98
e		0.40	
k		0.21	
L2	0.02	0.05	0.07

Figure 17. Footprint recommendations (dimensions in mm)

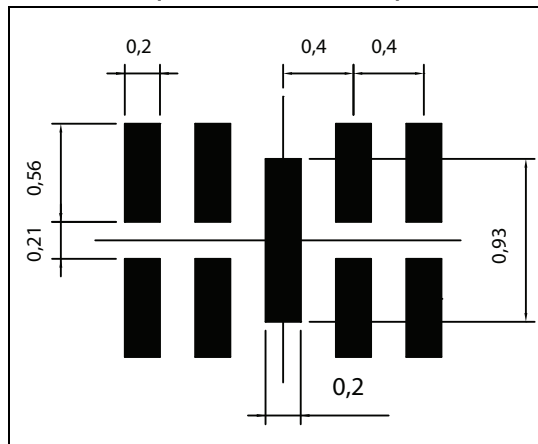

Figure 18. Marking

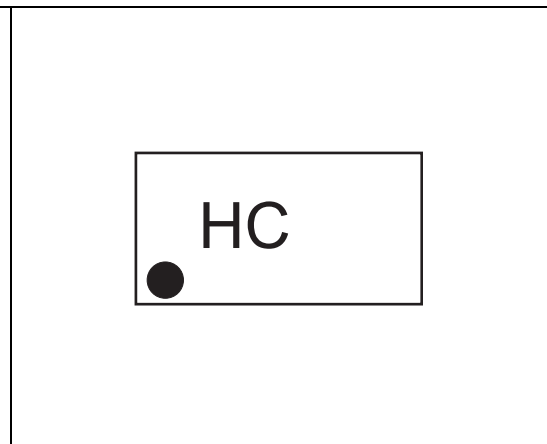
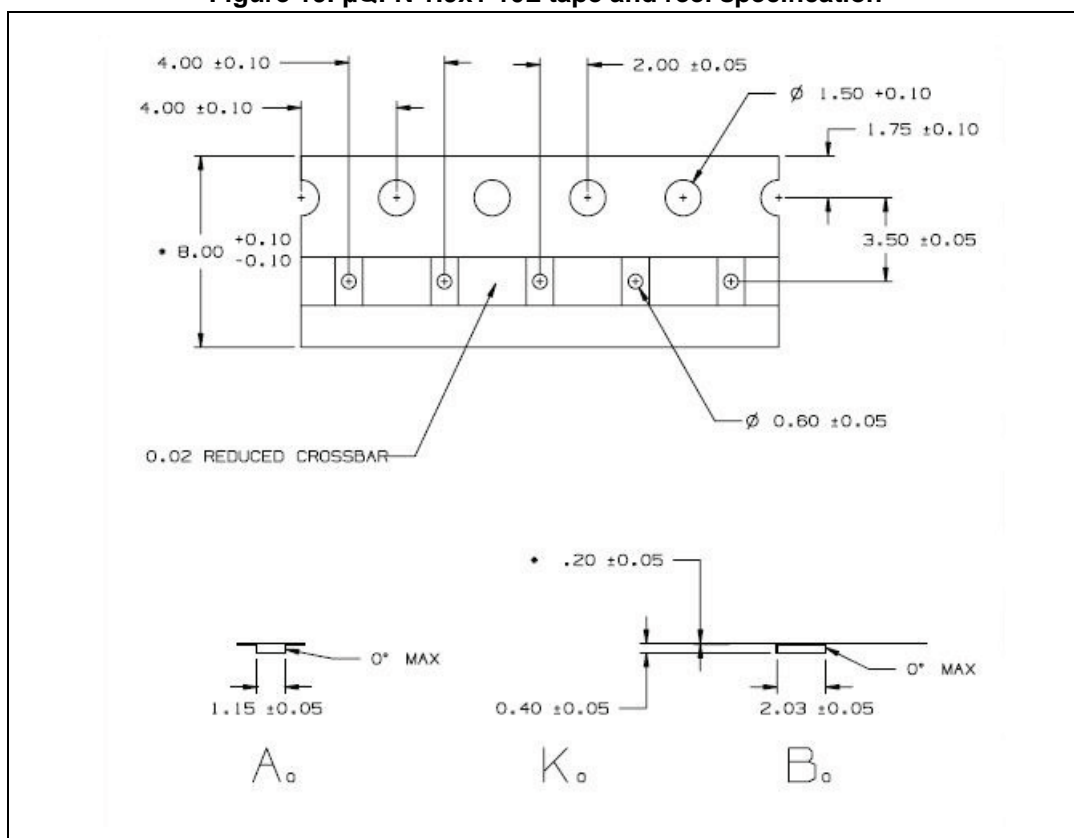
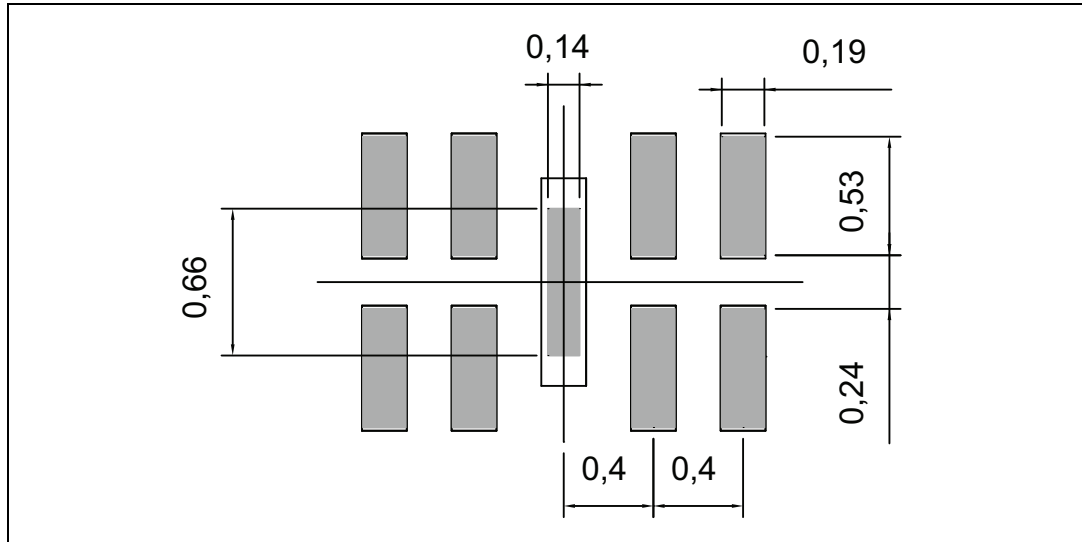

Figure 19.  $\mu$ QFN 1.9x1 10L tape and reel specification



### 3 Recommendation on PCB assembly

Figure 20. Recommended stencil window position



#### 3.1 Solder paste

1. Use halide-free flux, qualification ROL0 according to ANSI/J-STD-004.
2. "No clean" solder paste recommended.
3. Offers a high tack force to resist component displacement during PCB movement.
4. Use solder paste with fine particles: powder particle size 20-45  $\mu\text{m}$ .

#### 3.2 Placement

1. Manual positioning is not recommended.
2. It is recommended to use the lead recognition capabilities of the placement system, not the outline centering.
3. Standard tolerance of  $\pm 0.05$  mm is recommended.
4. 3.5 N placement force is recommended. Too much placement force can lead to squeezed out solder paste and cause solder joints to short. Too low placement force can lead to insufficient contact between package and solder paste that could cause open solder joints or badly centered packages.
5. To improve the package placement accuracy, a bottom side optical control should be performed with a high resolution tool.
6. For assembly, a perfect supporting of the PCB (all the more on flexible PCB) is recommended during solder paste printing, pick and place and reflow soldering by using optimized tools.



### 3.3 PCB design

1. To control the solder paste amount, the closed via is recommended instead of open vias.
2. The position of tracks and open vias in the solder area should be well balanced. The symmetrical layout is recommended, in case any tilt phenomena caused by asymmetrical solder paste amount due to the solder flow away.

Figure 21. Printed circuit board layout recommendations

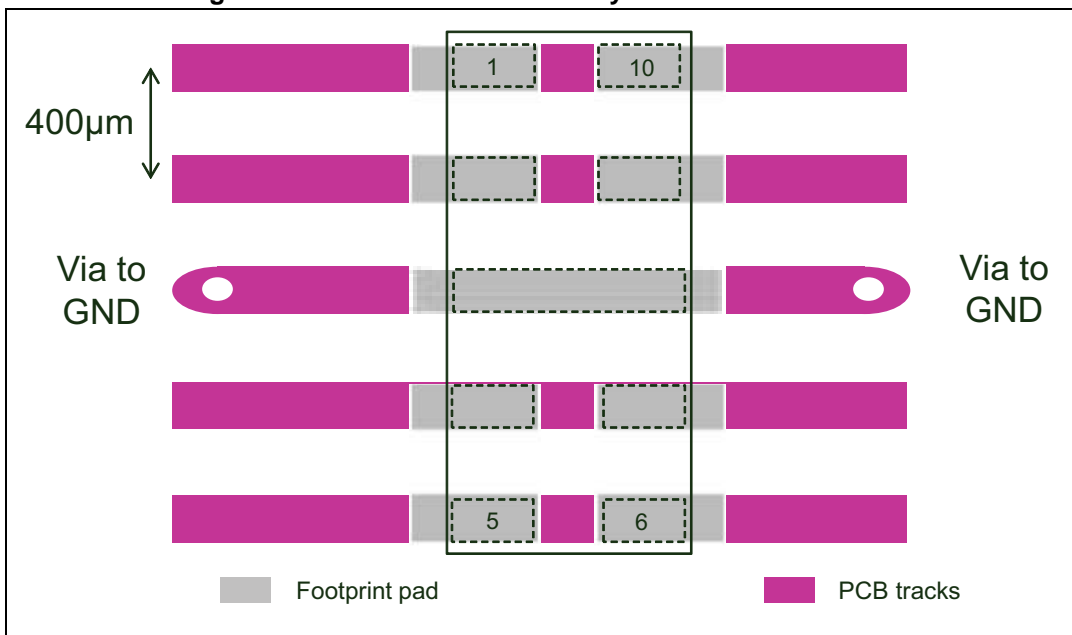

### 3.4 Reflow profile

Figure 22. ST ECOPACK® recommended soldering reflow profile for PCB mounting

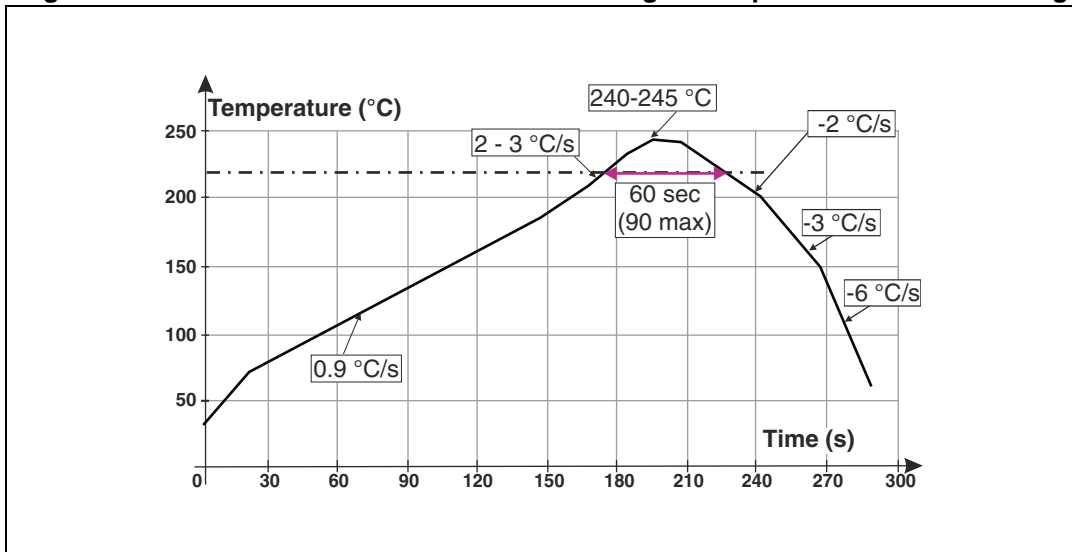

Note: Minimize air convection currents in the reflow oven to avoid component movement. Maximum soldering profile corresponds to the latest IPC/JEDEC J-STD-020.



## 4 Ordering information

Figure 23. Ordering information scheme

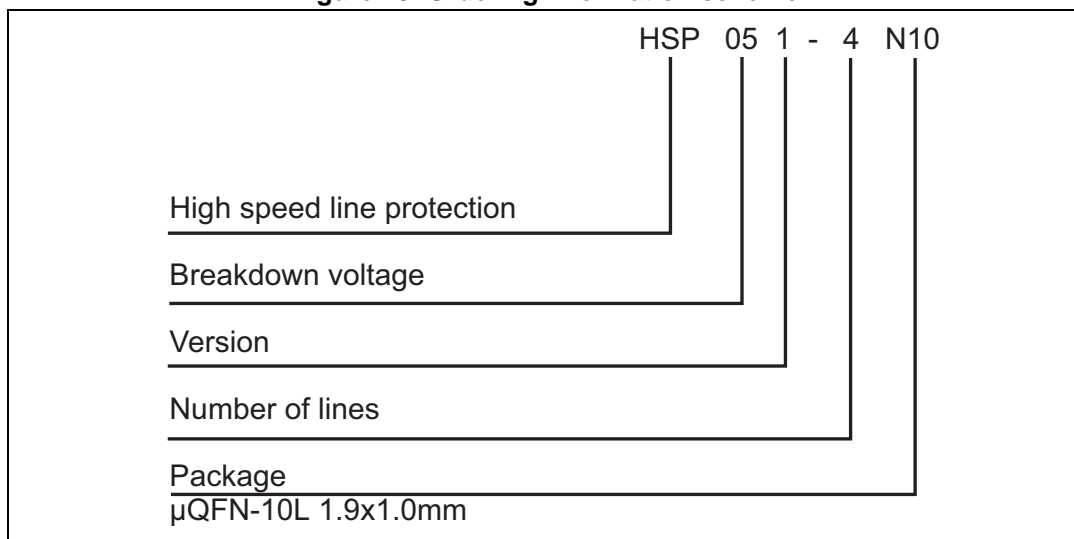

Table 4. Ordering information

Order code	Marking	Package	Weight	Base qty	Delivery mode
HSP051-4N10	HC	$\mu$ QFN-10L	1.61 mg	7000	Tape and reel

## 5 Revision history

Table 5. Document revision history

Date	Revision	Changes
11-Jul-2014	1	Initial release.

**IMPORTANT NOTICE – PLEASE READ CAREFULLY**

STMicroelectronics NV and its subsidiaries ("ST") reserve the right to make changes, corrections, enhancements, modifications, and improvements to ST products and/or to this document at any time without notice. Purchasers should obtain the latest relevant information on ST products before placing orders. ST products are sold pursuant to ST's terms and conditions of sale in place at the time of order acknowledgement.

Purchasers are solely responsible for the choice, selection, and use of ST products and ST assumes no liability for application assistance or the design of Purchasers' products.

No license, express or implied, to any intellectual property right is granted by ST herein.

Resale of ST products with provisions different from the information set forth herein shall void any warranty granted by ST for such product.

ST and the ST logo are trademarks of ST. All other product or service names are the property of their respective owners.

Information in this document supersedes and replaces information previously supplied in any prior versions of this document.

© 2014 STMicroelectronics – All rights reserved