



INVENTEK SYSTEMS
ISM4390-L57
Embedded Serial-to-Wi-Fi Module
eS-WiFi™
Data Sheet

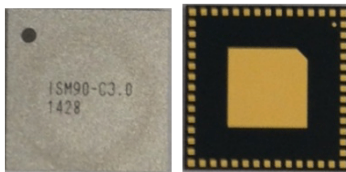

Table of Contents

1	GENERAL DESCRIPTION	3
2	PART NUMBER DETAIL DESCRIPTION	4
2.1	Ordering Information	4
3	GENERAL FEATURES	4
3.1	Limitations	4
4	SPECIFICATIONS	5
4.1	Module Architecture	5
5	ELECTRICAL SPECIFICATIONS	5
5.1	Recommended Operating Ratings	5
5.2	Environmental Specifications	5
6	PIN DEFINITION	6
6.1	Pin Out	6
6.2	Detailed Pin Description	7
6.3	Interface Selection Guide	9
7	SERIAL HOST INTERFACES AVAILABLE	9
7.1	UART	9
7.1.1	Data Mode	9
7.1.2	Flow Control	9
7.1.3	Supported Baud Rates	9
8	Wi-Fi RF SPECIFICATION	10
8.1	RF Specification	10
8.2	Wi-Fi RF Transmitter Specification	10
8.3	Wi-Fi RF Receiver Specification	12
9	ANTENNA PATTERNS	13
9.1	External Antenna	13
10	MECHANICAL SPECIFICATION	14
10.1	Mechanical Dimensions (mm)	14
10.2	Modules Dimensions (mm)	15
11	PRODUCT COMPLIANCE CONSIDERATIONS	16
12	REFLOW PROFILE	16
13	PACKING INFORMATION	17
13.1	MSL Level / Storage Condition	17
14	REVISION CONTROL	18
15	CONTACT INFORMATION	18

1 GENERAL DESCRIPTION

The Inventek ISM4390-L57 is an embedded (eS-WiFi™) 2.4 GHz wireless Internet Connectivity device. The Wi-Fi module hardware consists of an ARM Cortex™ M3 MCU host processor, and Broadcom Wi-Fi device. The module provides a UART interface enabling connection to an embedded design. The Wi-Fi module requires no operating system and has a completely integrated TCP/IP Stack that only requires AT commands to establish connectivity for your wireless product, minimizing development time, testing routines and certification. The low cost, small foot print (10.5 mm x 10.5 mm) and ease of design-in make it ideal for a range of embedded applications. The module hardware can be used with Inventek's AT Command set or with Broadcom's WICED™ SDK.

Summary of Key Features:

- 802.11 b/g/n compliant based on Broadcom MAC/Baseband/Radio device.
- Fully contained TCP/IP stack minimizing host CPU requirements.
- Configurable using AT commands.
- UART Host interface
- Network features: ICMP (Ping), ARP, DHCP, TCP, UDP.
- Low power operation (3.3V supply) with built-in low power modes.
- Secure Wi-Fi authentication WEP-128, WPA-PSK (TKIP), WPA2-PSK.
- Proven Interoperability
- Connects with other vendor's b/g/n Access Points in the Wireless LAN.
- Supported by Broadcom WICED™ SDK.

Typical Applications:

- PDA, Pocket PC, computing devices.
- Building automation and smart energy control.
- Industrial sensing and remote equipment monitoring.
- Warehousing, logistics and freight management.
- PC and gaming peripherals.
- Printers, scanners, alarm and video systems.
- Medical applications including patient monitoring and remote diagnostics.

2 PART NUMBER DETAIL DESCRIPTION

2.1 Ordering Information

Device	Description	Firmware	Ordering Number
ISM4390-L57	802.11b/g/n Wifi Module	UART	ISM4390-L57

3 GENERAL FEATURES

- Based on the Broadcom BCM4390 MAC/Baseband/Radio device.
- Supports Broadcom WICED SDK.
- ARM Cortex™ M3 MCU at 48 Mhz.
- 3.5 Mb SRAM, 16 Mb Flash
- IEEE 802.11n D7.0 -OFDM-72.2 Mbps -single stream w/20 MHz, Short GI
- IEEE 802.11g (OFDM 54 Mbps)
- IEEE 802.11b (DSSS 11Mbps)
 - WPA (Wi-Fi Protected Access) –PSK/TKIP
 - WPA2 (Wi-Fi Protected Access 2)- AES/CCMP/802.1x Authentication
 - WEP
- Inputs +3.3 V tolerant
- 7 GPIO Pins
- The devices operate from a 3.0 to 3.6 V power supply.
- -40 to +85 °C temperature range.
- Power-saving mode allows the design of low-power applications.
- Lead Free Design which is compliant with ROHS requirements.
- EMI/EMC Metal Shield for best RF performance in noisy environments and to accommodate for lower RF emissions/signature for easier FCC compliance.

3.1 Limitations

Inventek Systems products are not authorized for use in safety-critical applications (such as life support) where a failure of the Inventek Systems product would reasonably be expected to cause severe personal injury or death.

4 SPECIFICATIONS

4.1 Module Architecture

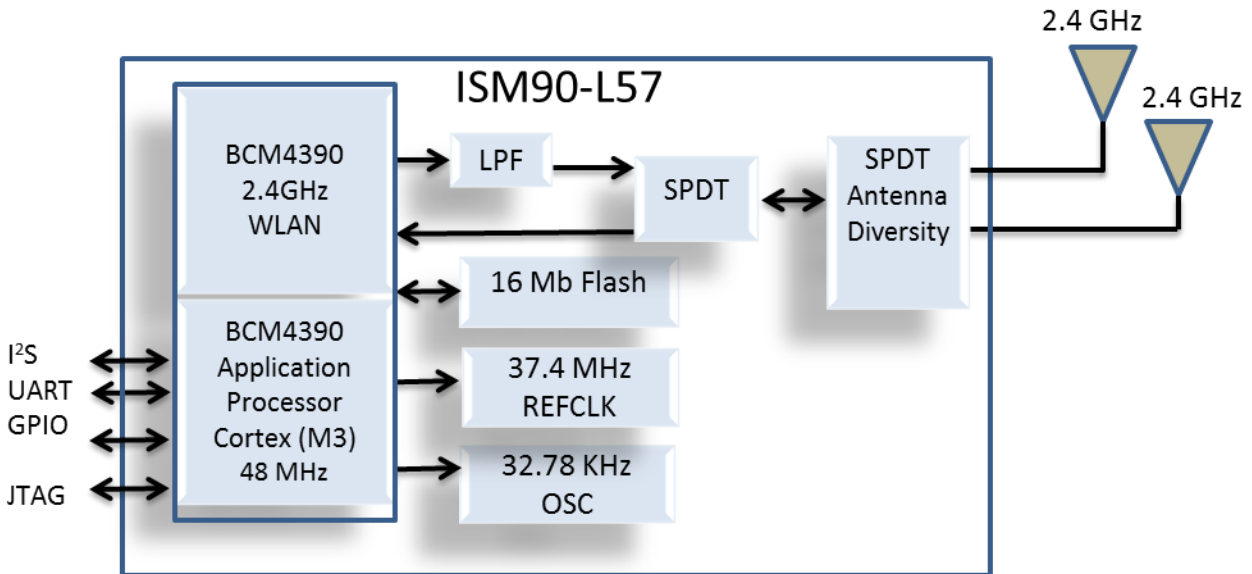

Figure 1 Inventek's ISM90_L57 General Block Diagram

5 ELECTRICAL SPECIFICATIONS

5.1 Recommended Operating Ratings

Symbol	Description	Min.	Typ.	Max.	Unit.
VDD	Wi-Fi Voltage	3.13	3.3	3.46	V
Voltage Ripple	+/- 2%	-	-	-	Voltage Ripple

5.2 Environmental Specifications

Item	Description
Operating temperature range	-40° C to +85° C
Storage temperature range	-40° C to +85° C
Humidity	95% max non-condensing , relative humidity

6 PIN DEFINITION

6.1 Pin Out

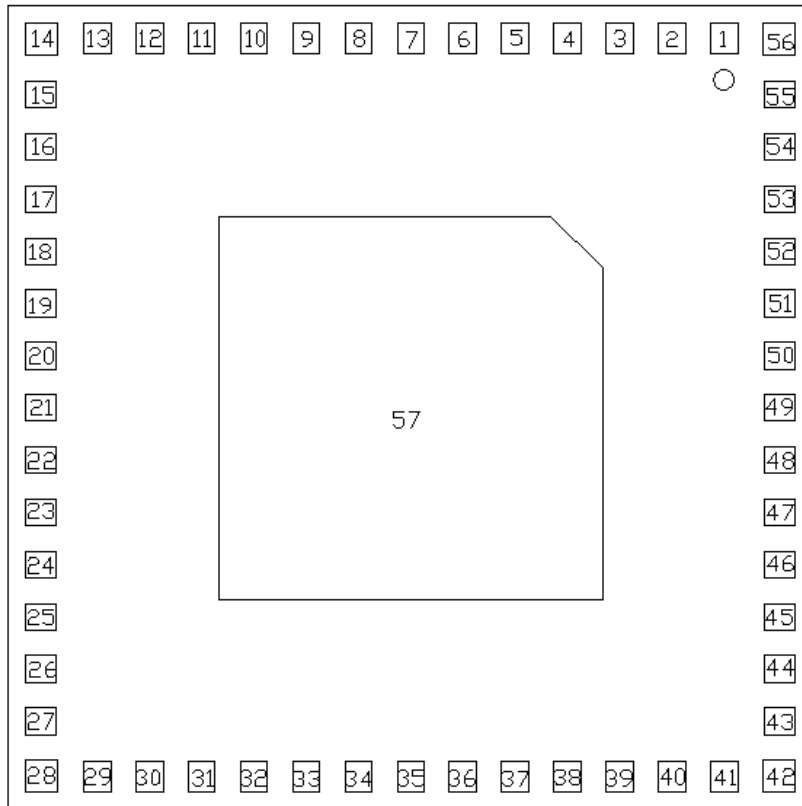

Top View

6.2 Detailed Pin Description

Pin	Type	Default Pin Name	Description
1	-	GND	Ground
2	I	VDD	3.3 V
3	-	GND	Ground
4	I/O	RESET_N	RESET_N
5	I/O	GPIO10/SPI_IRQ(A11)	GPIO/APP SPI IRQ
6	-	NC	Floating
7	I/O	OSC_32K_OUT	OSC 32K Signal Test Pin
8	I	VDD	3.3V
9	-	GND	Ground
10	I/O	ANTENNA1	Antenna Diversity RF_1
11	-	GND	Ground
12	I/O	WKUP/GPIO11 (A10)	Wakeup/GPIO
13	-	GND	Ground
14	I/O	ANTENNA0	Antenna Diversity RF_0
15	-	GND	Ground
16	I/O	GPIO2/I ² S_WS(A7)	I ² S Word Select
17	I/O	GPIO4/I ² S_CLK(A9)	I ² S Clock
18	I/O	GPIO3/I ² S_DO (A8)	I ² S Data Output
19	I/O	GPIO1/I ² S_DI (A6)	I ² S Data Input
20	-	GND	Ground
21	I/O	UART1_CTS/SCK (A1)	UART1 CTS/ APP SPI SCK
22	I/O	UART1_RX	UART1 RX
23	I/O	UART1_RTS (A0)	UART1 RTS
24	I/O	UART1_TX	UART1 TX
25	-	GND	Ground
26	I	VDD	3.3 V
27	-	GND	Ground
28	I/O	TCK (A3)	JTAG TCK signal/GPIO8
29	I/O	TDO (A5)	JTAG TDO signal/GPIO10
30	I/O	TMS (A2)	JTAG TMS signal/GPIO7
31	I/O	TDI (A4)	JTAG TDI signal/GPIO9
32	I/O	WRF_GPIO_OUT	GPIO
33	I/O	UART4_TX	UART4 Serial Output
34	I/O	UART4_RX	UART4 Serial Input
35	NC	NC	Floating

36	NC	NC	Floating
37	NC	NC	Floating
38	NC	NC	Floating
39	NC	NC	Floating
40	NC	NC	Floating
41	NC	NC	Floating
42	NC	NC	Floating
43	NC	NC	Floating
44	NC	NC	Floating
45	NC	NC	Floating
46	-	GND	Ground
47	I	VDD	3.3 V
48	-	GND	Ground
49	I/O	GPIO_B0	GPIO
50	I/O	GPIO_B1	GPIO
51	I/O	GPIO_B9	GPIO
52	I/O	GPIO_B10	GPIO
53	I/O	GPIO_B11	GPIO
54	I/O	GPIO_B8	GPIO
55	I/O	GPIO_B7	GPIO
56	-	GND	Ground
57	-	GND	Ground

6.3 Interface Selection Guide

ISM90 Signal	Default	Option 1	Option 2	Option 3	Option 4
GPIO A0	UART1_RTS	APP SPI CSB	UART3 RX	UART3 TX	GPIO
GPIO A1	UART1_CTS	APP SPI SCK	UART3 RX	UART3 TX	GPIO
GPIO A2	TMS	I2S_DI	UART3 RX	UART3 TX	GPIO
GPIO A3	TCK	I2S_WS	UART3 RX	UART3 TX	GPIO
GPIO A4	TDI	I2S_DO	UART3 RX	UART3 TX	GPIO
GPIO A5	TDO	I2S_CLK	UART3 RX	UART3 TX	GPIO
GPIO A6	I2S_DI	UART2_CTS	UART3 RX	UART3 TX	GPIO
GPIO A7	I2S_WS	UART2_RXD	UART3 RX	UART3 TX	GPIO
GPIO A8	I2S_D0	UART2_RTS	UART3 RX	UART3 TX	GPIO
GPIO A9	I2S_CLK	UART2_TXD	UART3 RX	UART3 TX	GPIO
GPIO A10	WAKE	GPIO	UART3 RX	UART3 TX	
GPIO A11	GPIO	SPI_IRQ	UART3 RX	UART3 TX	
UART1_TX	UART1_TX	APP SPI MOSI*	I2C_SCL	GPIO	
UART1_RX	UART1_RX	APP SPI MISO*	I2C_SDA	GPIO	

7 SERIAL HOST INTERFACES AVAILABLE

7.1 UART

A universal asynchronous receiver / transmitter (UART) with 3.3v logic levels is available.

7.1.1 Data Mode

When the eS-WiFi module is interfaced serially, the serial interface needs to be configured for 8 bit data, no parity, and one stop bit -- (8-n-1).

7.1.2 Flow Control

The eS-WiFi module doesn't require or support Flow Control, so Flow Control should be 'None'

7.1.3 Supported Baud Rates

The eS-WiFi module supports the following serial baud rates are supported: 1200, 2400, 4800, 9600, 19200, 38400, 57600, 115200, 230400, 460800, 921600, 1152000, 1382400, 1612800, 1834200, 2073600.

8 Wi-Fi RF SPECIFICATION

8.1 RF Specification

The ISM4390-L57 module complies with the following features and standards.
 The default Voltage is 3.3 V.

Features	Description
WLAN Standards	IEEE 802 Part 11b/g/n (802.11b/g/n single stream n)
Antenna Port	Support Antenna Diversity
Frequency Band	2.4000 – 2.497 GHz (2.4 GHz ISM Band)
Number of selectable Sub channels	14 channels (Region Dependent)
Modulation	OFDM, DSSS (Direct Sequence Spread Spectrum), DBPSK, DQPSK, CCK , 16QAM, 64QAM
Supported rates	1,2, 5.5,11,6,9,12,24,36,48,54 Mbps & HT20 MCS 0~7
Maximum receive input level	- 10dBm (with PER < 8%@11 Mbps) - 20dBm (with PER < 10%@54 Mbps) - 20dBm (with PER < 10%@MCS7)
Output Power	17dBm @ 802.11b 13dBm @ 802.11g 13dBm @ 802.11n
Carrier Frequency Accuracy	+/- 20ppm (crystal: 26MHz +/-10ppm in 25 ⁰ C)

8.2 Wi-Fi RF Transmitter Specification

802.11b Transmit					
Item	Condition	Min.	Typ.	Max.	Unit
Transmit output power level	1M/2M/5.5M/11M	15.5	17	18.5	dBm
Transmit center frequency tolerance		-20	0	20	ppm
Transmit spectrum mask	$F_c - 22\text{MHz} < F < F_c - 11\text{MHz}$ & $F_c + 11\text{MHz} < F < F_c + 22\text{MHz}$ (1/2/5.5/11Mbps; channel 1~13)			-30*	dBr
	$F < F_c - 22\text{MHz}$ & $F > F_c + 22\text{MHz}$ (1/2/5.5/11Mbps; channel 1~13)			-50*	dBr
Transmit power	10% ~ 90 %		0.3	2*	us

-on					
Transmit power -down	90% ~ 10 %		1.5	2*	us
Transmit modulation accuracy	1/2/5.5/11 Mbps		-17	-10	dB

“*” indicates IEEE802.11 specification

802.11g Transmit					
Item	Condition	Min.	Typ.	Max.	Unit
Transmit output power level	6M/9M/12M/18M/24M/36M/48M/54M	11.5	13	14.5	dBm
					dBm
					dBm
Transmit center frequency tolerance		-20	0	20	ppm
Transmit modulation accuracy	6Mbps		-30	-5*	dB
	9Mbps		-30	-8*	dB
	12Mbps		-30	-10*	dB
	18Mbps		-30	-13*	dB
	24Mbps		-30	-16*	dB
	36Mbps		-30	-19*	dB
	48Mbps		-30	-22*	dB
Transmit spectrum mask	@ 11MHz			-20*	dBr
	@ 20MHz			-28*	dBr
	@ 30MHz			-40*	dBr

“*” indicates IEEE802.11 specification

802.11n Transmit					
Item	Condition	Min.	Typ.	Max.	Unit
Transmit output power level	HT20 MCS 0~7	11.5	13	14.5	dBm
					dBm
					dBm
Transmit center frequency		-20	0	20	ppm

tolerance					
Transmit modulation accuracy	HT20, MCS0~7		-30	-27*	dB
					dB
Transmit Spectrum mask	@ 11MHz			-20*	dBr
	@ 20MHz			-28*	dBr
	@ 30MHz			-40*	dBr

“*” indicates IEEE802.11 specification

8.3 Wi-Fi RF Receiver Specification

802.11 b Receiver					
Item	Condition	Min.	Typ.	Max.	Unit
Receiver minimum input level sensitivity (PER< 8 %)	1Mbps		-90	-80*	dBm
	2Mbps		-90	-80*	dBm
	5.5Mbps		-90	-76*	dBm
	11Mbps		-87	-76*	dBm
Receiver maximum input level sensitivity (PER< 8 %)	1/2/5.5/11 Mbps			-10*	dBm

“*” indicates IEEE802.11 specification

802.11g Receiver					
Item	Condition	Min.	Typ.	Max.	Unit
Receiver minimum input level sensitivity (PER<10 %)	6Mbps		-85	-82*	dBm
	9Mbps		-85	-81*	dBm
	12Mbps		-85	-79*	dBm
	18Mbps		-84.5	-77*	dBm
	24Mbps		-82	-74*	dBm
	36Mbps		-78.5	-70*	dBm
	48Mbps		-74	-66*	dBm
	54Mbps		-70	-65*	dBm
Receiver maximum input level (PER<10%)	6/9/12/18/24/36/48/54			-20*	dBm

“*” indicates IEEE802.11 specification

802.11n Receiver					
Item	Condition	Min.	Typ.	Max.	Unit
Receiver minimum input level sensitivity (PER<10 %)	HT20, MCS0		-84	-82*	dBm
	HT20, MCS1		-84	-79*	dBm
	HT20, MCS2		-82.5	-77*	dBm
	HT20, MCS3		-80.5	-74*	dBm
	HT20, MCS4		-77	-70*	dBm
	HT20, MCS5		-73	-66*	dBm
	HT20, MCS6		-71	-65*	dBm
Receiver maximum input level (PER<10%)	HT20, MCS7		-70	-64*	dBm
	MSC0~MSC7			-20*	dBm

“*” indicates IEEE802.11 specification

9 ANTENNA PATTERNS

9.1 External Antenna

We recommend using the 50 Ohm Inventek U.FL PCB antenna .The part number is W24P-U. It is a 2.4 GHz PCB antenna with a U.FL connector.

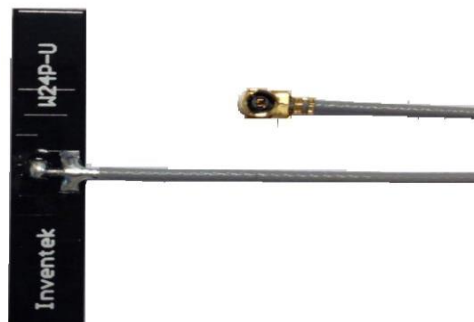

10 MECHANICAL SPECIFICATION

10.1 Mechanical Dimensions (mm)

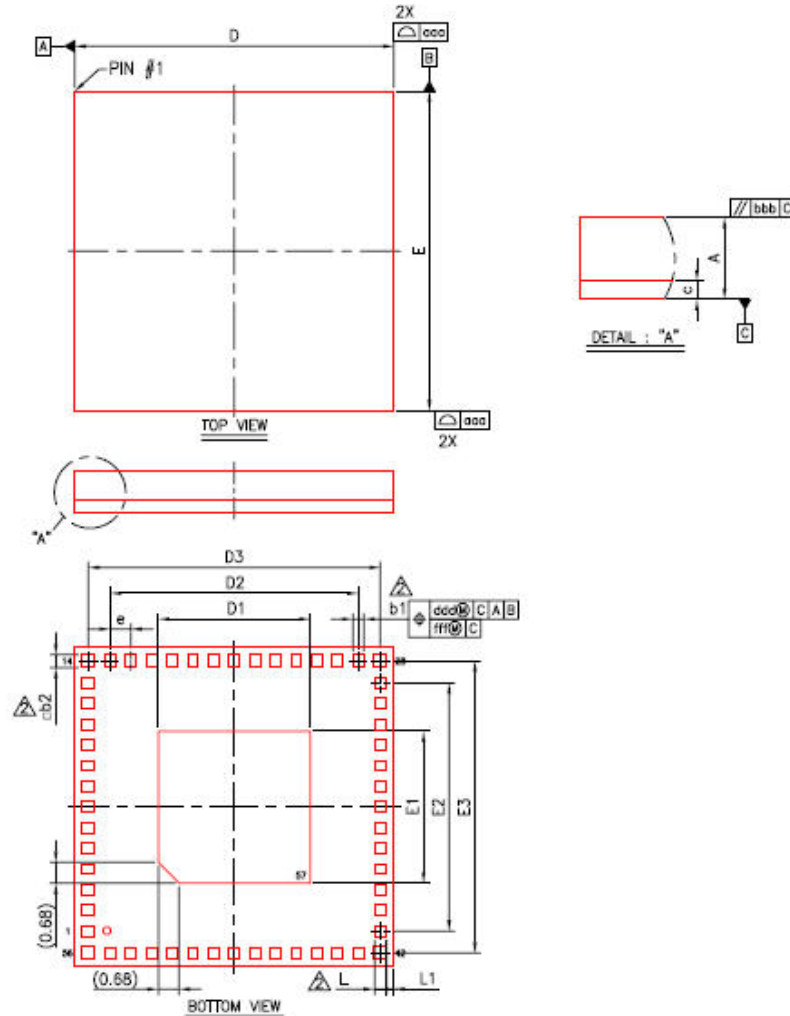

Symbol	Dimension In mm			Dimension In Inch		
	MIN	NOM	MAX	MIN	NOM	MAX
A	—	—	1.40	—	—	0.055
c	0.36	0.40	0.44	0.014	0.016	0.017
D	10.40	10.50	10.60	0.409	0.413	0.417
E	10.40	10.50	10.60	0.409	0.413	0.417
D1	—	5.00	—	—	0.197	—
E1	—	5.00	—	—	0.197	—
D2	—	8.16	—	—	0.321	—
E2	—	8.16	—	—	0.321	—
D3	—	9.60	—	—	0.378	—
E3	—	9.60	—	—	0.378	—
e	—	0.68	—	—	0.027	—
b1	—	0.35	—	—	0.014	—
b2	—	0.42	—	—	0.017	—
L	—	0.40	—	—	0.016	—
L1	—	0.24	—	—	0.009	—
aaa	0.15			0.006		
bbb	0.10			0.004		
ddd	0.10			0.004		
fff	0.05			0.002		

NOTE:

1. CONTROLLING DIMENSION : MILLIMETER
- △ DIMENSION b1,b2,L IS MEASURED AT THE MAXIMUM OPENING DIAMETER, PARALLEL TO PRIMARY DATUM C.

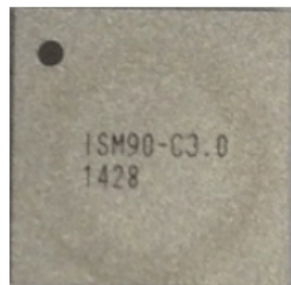

Top View

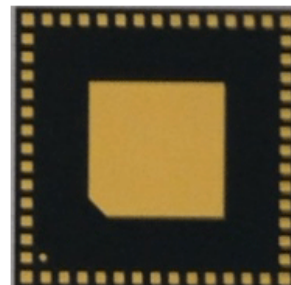

Bottom View

10.2 Modules Dimensions (mm)

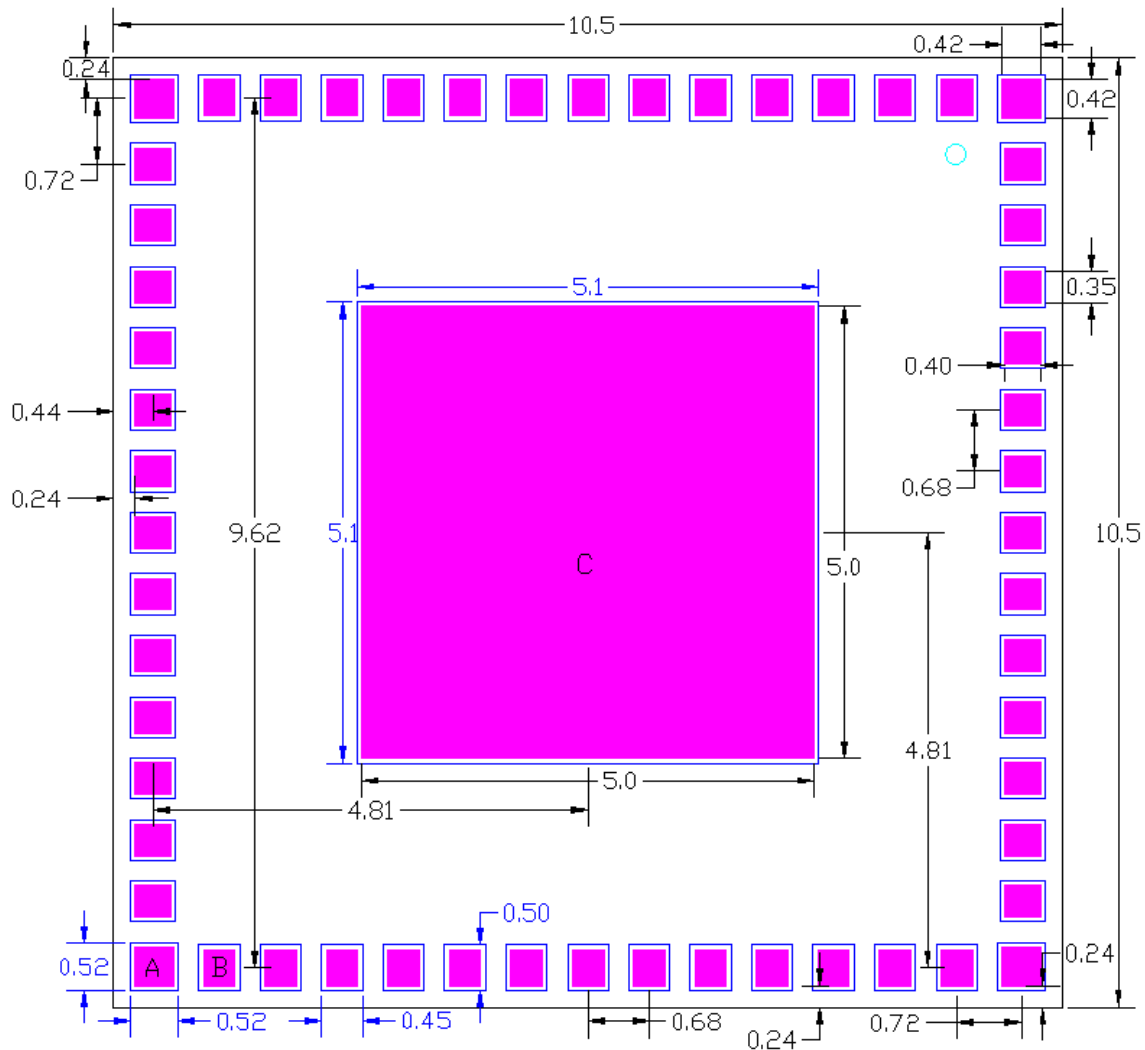

Note:

1. Please use Un-Solder Mask to design the Module Footprint.
2. There are three types pad size in the Module.
 - Type A:
Pad size: $0.42 \times 0.42 \text{ mm}^2$ & Solder Mask size: $0.52 \times 0.52 \text{ mm}^2$
 - Type B
Pad size: $0.35 \times 0.4 \text{ mm}^2$ & Solder Mask size: $0.45 \times 0.5 \text{ mm}^2$
 - Type C
Pad size: $5 \times 5 \text{ mm}^2$ & Solder Mask size: $5.1 \times 5.1 \text{ mm}^2$

11 PRODUCT COMPLIANCE CONSIDERATIONS

RoHS: Restriction of Hazardous Substances (RoHS) directive has come into force since 1st July 2006 all electronic products sold in the EU must be free of hazardous materials, such as lead. Inventek is fully committed to being one of the first to introduce lead-free products while maintaining backwards compatibility and focusing on a continuously high level of product and manufacturing quality.

EMI/EMC: The Inventek module design embeds EMI/EMC suppression features and accommodations to allow for higher operational reliability in noisier (RF) environments and easier integration compliance in host (OEM) applications.

12 REFLOW PROFILE

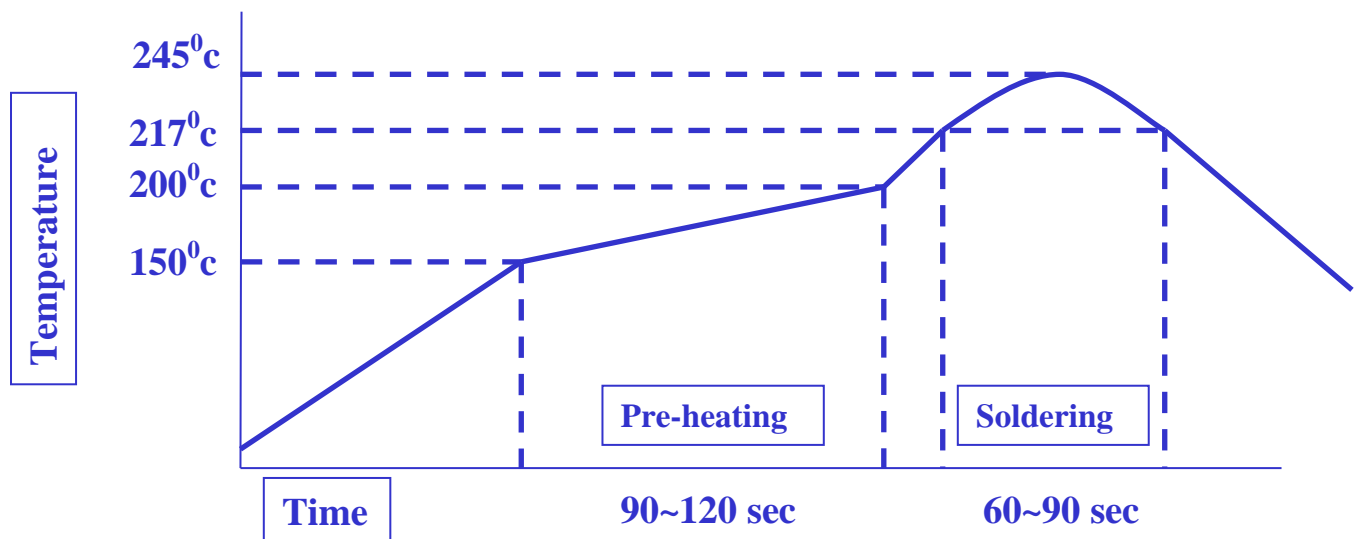

13 PACKING INFORMATION

13.1 MSL Level / Storage Condition

	<p>Caution This bag contains MOISTURE-SENSITIVE DEVICES</p>	<p>LEVEL 3 If blank, see adjacent bar code label</p>
	<ol style="list-style-type: none"> 1. Calculated shelf life in sealed bag: 12 months at <math><40^{\circ}\text{C}</math> and <math><90\%</math> relative humidity (RH) 2. Peak package body temperature: <u>260</u> °C If blank, see adjacent bar code label 3. After bag is opened, devices that will be subjected to reflow solder or other high temperature process must be <ol style="list-style-type: none"> a) Mounted within: <u>168</u> hours of factory conditions If blank, see adjacent bar code label ≤ 30 °C/60% RH. or b) Stored per J-STD-033 4. Devices require bake, before mounting, if: <ol style="list-style-type: none"> a) Humidity Indicator Card reads >10% for level 2a - 5a devices or >60% for level 2 devices whwn read at 23 ±5°C b) 3a or 3b are not met 5. If baking is required, refer to IPC/JEDEC J-STD-033 for bake procedure. 	
<p>Bag Seal Date: <u>APR 26 2011</u> If blank, see adjacent bar code label</p>		
<p>Note: Level and body temperature defined by IPC/JEDEC J-STD-020</p>		

14 REVISION CONTROL

Document : ISM4390-L57	Wi-Fi module
External Release	DOC-DS-20081

Date	Author	Revision	Comment
7/24/2014	KMT	1.0	Preliminary
8/8/2014	KMT	2.0	Updated Pin descriptions, Host Interfaces, Block Diagram, and Electrical Specification
9/25/2014	MT	2.1	Updated 6.1 to correct view

15 CONTACT INFORMATION

Inventek Systems
 2 Republic Road
 Billerica Ma, 01862
 Tel: 978-667-1962
Sales@inventeksys.com

www.inventeksys.com

Inventek Systems reserves the right to make changes without further notice to any products or data herein to improve reliability, function, or design. The information contained within is believed to be accurate and reliable. However Inventek Systems does not assume any liability arising out of the application or use of this information, nor the application or use of any product or circuit described herein, neither does it convey any license under its patent rights nor the rights of others.