

# 16-Channel 50mA LED Driver with Buck Controller

## FEATURES

- **6V to 55V Power Input Voltage Range**
- **16 Independent LED Outputs Up to 75mA/36V**
- **±4% LED Current Matching at 50mA (Typ ±1%)**
- **6-Bit Dot Correction Current Adjustment**
- **12-Bit Grayscale PWM Dimming**
- **0.5µs Minimum LED On-Time**
- **Adaptive LED Bus Voltage for High Efficiency**
- **Cascadable 30MHz LVDS Serial Data Interface**
- Full Diagnostic and Protection: Individual Open/Short LED and Overtemperature Fault
- 40-Lead 6mm × 6mm QFN Package

## APPLICATIONS

- Large Screen Display LED Backlighting
- Mono-, Multi-, Full-Color LED Displays
- LED Billboards and Signboards

LT, LT, LTC, LTM, Linear Technology and the Linear logo are registered trademarks and True Color PWM is a trademark of Linear Technology Corporation. All other trademarks are the property of their respective owners. Protected by U.S. Patents, including 8058810

## DESCRIPTION

The LT<sup>®</sup>3745-1 integrates a 16-channel LED driver with a 55V buck controller. The LED driver lights up to 75mA/36V of LEDs in series per channel, and the buck controller generates an adaptive bus voltage supplying the parallel LED strings. Each channel has individual 6-bit dot correction current adjustment and 12-bit grayscale PWM dimming. Both dot correction and grayscale are accessible via a serial data interface in LVDS logic. A ±4% LED current matching and a 0.5µs minimum LED on-time can be achieved at 50mA per channel.

The LT3745-1 performs full diagnostic and protection against open/short LED and overtemperature fault. The fault status is sent back through the serial data interface. The 30MHz fully-buffered, cascadable LVDS serial data interface makes the chip extremely suitable for large screen LCD dynamic backlighting and mono-, multi-, full-color LED displays. The LT3745 uses a TTL/CMOS serial data interface instead of LVDS.

## TYPICAL APPLICATION

**16-Channel LED Driver, 1MHz Buck, 10 LEDs, 25mA to 75mA per Channel, 500Hz 12-Bit Dimming**

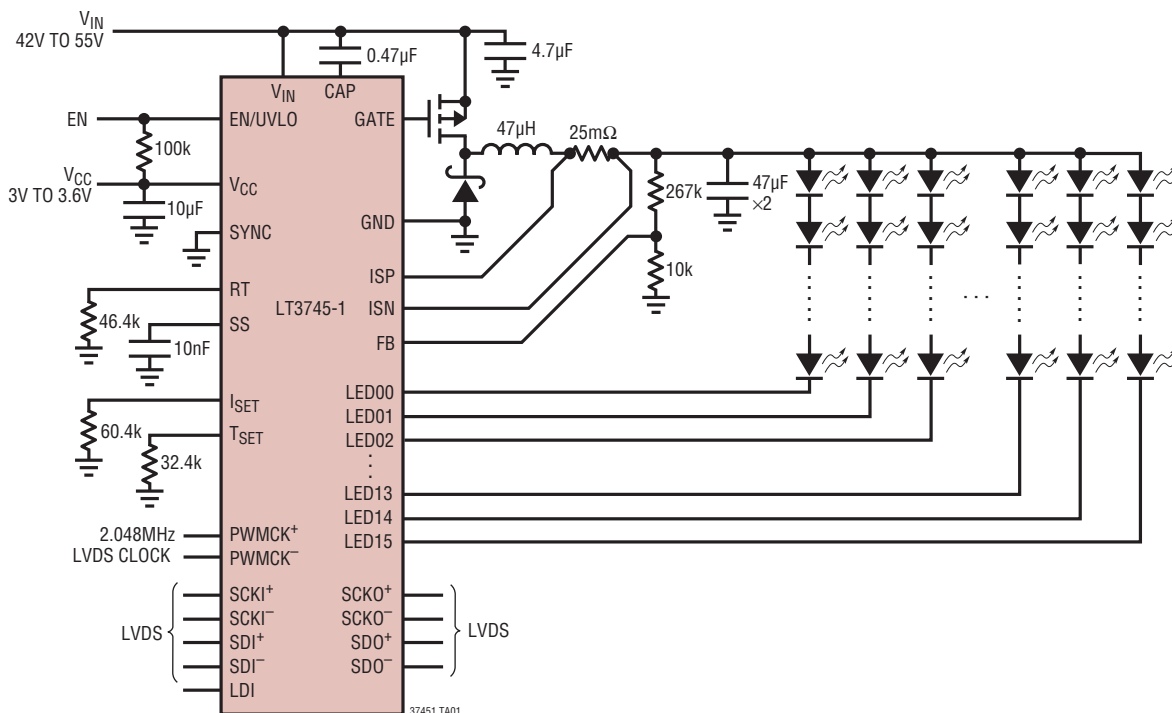

37451f

# LT3745-1

## ABSOLUTE MAXIMUM RATINGS

(Note 1)

|  |                           |
|--|---------------------------|
| $V_{IN}$ .....   | 57V                       |
| CAP .....  | $V_{IN} - 8V$ to $V_{IN}$ |
| GATE .....   | CAP to $V_{IN}$           |
| LED00 to LED15, ISP, ISN .....   | 40V                       |
| ISP .....  | $ISN - 1V$ to $ISN + 1V$  |
| FB, RT, $T_{SET}$ , $I_{SET}$ .....  | 2V                        |
| $V_{CC}$ .....   | -0.3V to 4V               |
| SCKI <sup>+</sup> , SCKI <sup>-</sup> , SCKO <sup>+</sup> , SCKO <sup>-</sup> , SDI <sup>+</sup> , SDI <sup>-</sup> ,<br>SDO <sup>+</sup> , SDO <sup>-</sup> , LDI, PWMCK <sup>+</sup> , PWMCK <sup>-</sup> , SYNC,<br>SS, EN/UVLO ..... | -0.3V to $V_{CC}$         |
| Operating Junction Temperature Range<br>(Notes 2, 3)   |                           |
| LT3745E-1 .....  | -40°C to 125°C            |
| LT3745I-1 .....  | -40°C to 125°C            |
| Storage Temperature Range .....  | -65°C to 125°C            |

## PIN CONFIGURATION

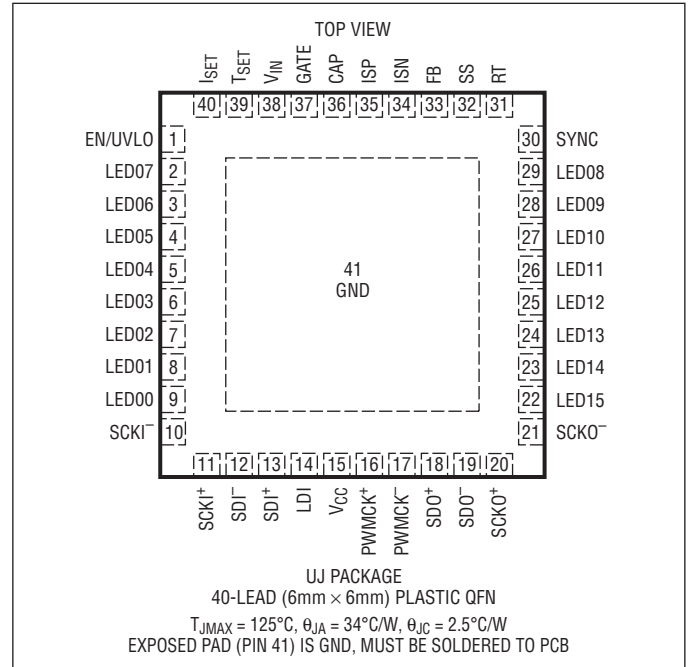

## ORDER INFORMATION

| LEAD FREE FINISH | TAPE AND REEL     | PART MARKING* | PACKAGE DESCRIPTION             | TEMPERATURE RANGE |
|------------------|-------------------|---------------|---------------------------------|-------------------|
|                  | LT3745EUJ-1#TRPBF | LT3745UJ-1    | 40-Lead (6mm × 6mm) Plastic QFN | -40°C to 125°C    |
|                  | LT3745IUJ-1#PBF   | LT3745UJ-1    | 40-Lead (6mm × 6mm) Plastic QFN | -40°C to 125°C    |

Consult LTC Marketing for parts specified with wider operating temperature ranges. \*The temperature grade is identified by a label on the shipping container.

Consult LTC Marketing for information on nonstandard lead based finish parts.

For more information on lead free part marking, go to: <http://www.linear.com/leadfree/>

For more information on tape and reel specifications, go to: <http://www.linear.com/tapeandreeel/>

**ELECTRICAL CHARACTERISTICS** The ● denotes the specifications which apply over the full operating temperature range, otherwise specifications are at  $T_A = 25^{\circ}C$ .  $V_{IN} = 12V$ ,  $V_{CC} = 3.3V$ ,  $V_{EN/UVLO} = 1.5V$ ,  $V_{FB} = 1.5V$ ,  $V_{ISP} = V_{ISN} = 0V$ ,  $R_T = 105k$ ,  $R_{ISET} = 60.4k$ ,  $C_{CAP} = 0.47\mu F$  to  $V_{IN}$ , unless otherwise noted.

| SYMBOL        | PARAMETER                        | CONDITIONS   | MIN | TYP                    | MAX       | UNITS                     |
|---------------|----------------------------------|--|-----|------------------------|-----------|---------------------------|
| <b>Supply</b> |                                  |  |     |                        |           |                           |
| $V_{IN}$      | $V_{IN}$ Operating Voltage       |  | ●   | 6                      | 55        | V                         |
| $I_{VIN}$     | $V_{IN}$ Supply Current          | $V_{EN/UVLO} = 0V$<br>No Switching   |     | 0.2<br>0.4             | 2<br>0.55 | $\mu A$<br>mA             |
| $V_{CC}$      | $V_{CC}$ Operating Voltage       |  | ●   | 3                      | 3.6       | V                         |
| $I_{VCC}$     | $V_{CC}$ Supply Current (Note 4) | $V_{EN/UVLO} = 0V$<br>LED Channel Off, 30MHz Data Off<br>LED Channel On, 30MHz Data Off<br>LED Channel On, 30MHz Data On |     | 0.25<br>11<br>16<br>19 |           | $\mu A$<br>mA<br>mA<br>mA |

37451f

**ELECTRICAL CHARACTERISTICS** The ● denotes the specifications which apply over the full operating temperature range, otherwise specifications are at  $T_A = 25^\circ\text{C}$ .  $V_{IN} = 12\text{V}$ ,  $V_{CC} = 3.3\text{V}$ ,  $V_{EN/UVLO} = 1.5\text{V}$ ,  $V_{FB} = 1.5\text{V}$ ,  $V_{ISP} = V_{ISN} = 0\text{V}$ ,  $R_T = 105\text{k}$ ,  $R_{ISET} = 60.4\text{k}$ ,  $C_{CAP} = 0.47\mu\text{F}$  to  $V_{IN}$ , unless otherwise noted.

| SYMBOL                                    | PARAMETER  | CONDITIONS   | MIN                  | TYP                  | MAX                | UNITS             |
|---|--|--|----------------------|----------------------|--------------------|-------------------|
| <b>Undervoltage Lockout (UVLO)</b>        |  |  |                      |                      |                    |                   |
|   | $V_{CC}$ UVLO Threshold                                | $V_{CC}$ Rising<br>$V_{CC}$ Falling  | 2.76<br>2.58         | 2.86<br>2.68         | 2.96<br>2.78       | V<br>V            |
|   | EN/UVLO Shutdown Threshold<br>UVLO Threshold           | $I_{VCC} < 1\text{mA}$<br>$V_{EN/UVLO}$ Rising<br>$V_{EN/UVLO}$ Falling            | 0.35<br>1.26<br>1.18 | 1.30<br>1.34<br>1.22 | 1.34<br>1.26       | V<br>V<br>V       |
| $I_{EN/UVLO}$                             | EN/UVLO Bias Current                                   | $V_{EN/UVLO} = V_{CC} = 3.3\text{V}$   |                      | 0.1                  | 1                  | $\mu\text{A}$     |
|   | $(V_{IN} - V_{CAP})$ UVLO Threshold                    | $(V_{IN} - V_{CAP})$ Rising<br>$(V_{IN} - V_{CAP})$ Falling                        | 4.6<br>4.2           | 4.9<br>4.5           | 5.2<br>4.8         | V<br>V            |
| <b>Soft-Start (SS)</b>                    |  |  |                      |                      |                    |                   |
| $I_{SS}$                                  | Soft-Start Charge Current                              | $V_{SS} = 1\text{V}$   | -16                  | -12                  | -8                 | $\mu\text{A}$     |
|   | Soft-Start Discharge Current                           | $V_{SS} = V_{CC}$ , $V_{EN/UVLO} = 1\text{V}$                                      |                      | 330                  |                    | $\mu\text{A}$     |
| $V_{SS(TH)}$                              | Soft-Start Reset Threshold                             |  |                      | 0.35                 |                    | V                 |
| <b>Oscillator</b>                         |  |  |                      |                      |                    |                   |
| $V_{RT}$                                  | RT Pin Voltage   |  | 1.186                | 1.205                | 1.224              | V                 |
| $I_{RT}$                                  | RT Pin Current Limit                                   | $V_{RT} = 0\text{V}$   |                      | -80                  |                    | $\mu\text{A}$     |
| $f_{OSC}$                                 | Oscillator Frequency                                   | $R_T = 280\text{k}$<br>$R_T = 105\text{k}$<br>$R_T = 46.4\text{k}$                 | 184<br>460<br>935    | 204<br>510<br>1035   | 224<br>560<br>1135 | kHz<br>kHz<br>kHz |
| $f_{SYNC}$                                | Sync Frequency Range (Note 5)                          | $R_T = 348\text{k}$  | 200                  |                      | 1000               | kHz               |
|   | SYNC LOGIC<br>High Level Voltage<br>Low Level Voltage  | $V_{CC} = 3\text{V}$ to $3.6\text{V}$  | 2.4<br>0             |                      | $V_{CC}$<br>0.6    | V<br>V            |
| <b>Error Amplifiers and Loop Dynamics</b> |  |  |                      |                      |                    |                   |
| $V_{FB}$                                  | FB Regulation Voltage                                  | $V_{ISN} = 5\text{V}$  | ● 1.186              | 1.210                | 1.234              | V                 |
| $I_{FB}$                                  | FB Input Bias Current                                  | $V_{ISN} = 5\text{V}$ , $V_{FB}$ Regulated   |                      | -120                 |                    | nA                |
|   | LED Regulation Voltage                                 | $V_{ISN} = 5\text{V}$ , $V_{FB} = 1\text{V}$                                       | 0.6                  | 0.7                  | 0.8                | V                 |
| $t_{OFF(MIN)}$                            | Minimum GATE Off-Time                                  | $V_{ISP} = V_{ISN} = 5\text{V}$ , $V_{FB} = 1\text{V}$                             |                      | 120                  |                    | ns                |
| $t_{ON(MIN)}$                             | Minimum GATE On-Time                                   | $(V_{ISP} - V_{ISN}) = 60\text{mV}$ , $V_{ISN} = 5\text{V}$ , $V_{FB} = 1\text{V}$ |                      | 200                  |                    | ns                |
| <b>Current Sense Amplifier</b>            |  |  |                      |                      |                    |                   |
|   | ISP/ISN Pin Common Mode                                | $V_{ISP} = V_{ISN}$  | ● 0                  |                      | 36                 | V                 |
|   | $V_{IN}$ to ISN Dropout Voltage ( $V_{IN} - V_{ISN}$ ) | $V_{ISP} = V_{ISN}$ , $V_{FB} = 1\text{V}$   | ●                    | 1.7                  | 2.1                | V                 |
|   | Current Limit Sense Threshold ( $V_{ISP} - V_{ISN}$ )  | $V_{FB} = 1\text{V}$   | 30                   | 44                   | 58                 | mV                |
| $I_{ISP}$                                 | ISP Input Bias Current                                 |  |                      | -24                  |                    | $\mu\text{A}$     |
| $I_{ISN}$                                 | ISN Input Bias Current                                 |  |                      | -48                  |                    | $\mu\text{A}$     |
| <b>Gate Driver</b>                        |  |  |                      |                      |                    |                   |
| $V_{BIAS}$                                | CAP Bias Voltage ( $V_{IN} - V_{CAP}$ )                | $7\text{V} < V_{IN} < 55\text{V}$  | 6.4                  | 6.8                  | 7.1                | V                 |
| $I_{CAP}$                                 | CAP Bias Current Limit                                 | $(V_{IN} - V_{CAP}) = V_{BIAS} - 0.5\text{V}$                                      |                      | 22                   |                    | mA                |
|   | GATE High Level ( $V_{IN} - V_{GATE}$ )                | $I_{GATE} = -100\text{mA}$   |                      | 0.4                  |                    | V                 |
|   | GATE Low Level ( $V_{GATE} - V_{CAP}$ )                | $I_{GATE} = 100\text{mA}$  |                      | 0.3                  |                    | V                 |
|   | GATE Rise Time   | $C_{GATE} = 3.3\text{nF}$ to $V_{IN}$  |                      | 30                   |                    | ns                |
|   | GATE Fall Time   | $C_{GATE} = 3.3\text{nF}$ to $V_{IN}$  |                      | 30                   |                    | ns                |

## ELECTRICAL CHARACTERISTICS

The ● denotes the specifications which apply over the full operating temperature range, otherwise specifications are at  $T_A = 25^\circ\text{C}$ .  $V_{IN} = 12\text{V}$ ,  $V_{CC} = 3.3\text{V}$ ,  $V_{EN/UVLO} = 1.5\text{V}$ ,  $V_{FB} = 1.5\text{V}$ ,  $V_{ISP} = V_{ISN} = 0\text{V}$ ,  $R_T = 105\text{k}$ ,  $R_{ISET} = 60.4\text{k}$ ,  $C_{CAP} = 0.47\mu\text{F}$  to  $V_{IN}$ , unless otherwise noted.

| SYMBOL                             | PARAMETER  | CONDITIONS  | MIN         | TYP                  | MAX                | UNITS          |               |
|------------------------------------|--|---|-------------|----------------------|--------------------|----------------|---------------|
| <b>LED Driver</b>                  |  |   |             |                      |                    |                |               |
| $V_{ISET}$                         | Trimmed $I_{SET}$ Pin Voltage  |   | ● 1.181     | 1.205                | 1.229              | V              |               |
|                                    | LEDxx Operating Voltage  | $V_{IN} = 48\text{V}$ , $V_{ISP} = V_{ISN} = V_{LEDxx}$   | ●           |                      | 36                 | V              |               |
|                                    | LEDxx Leakage Current  | LED Channel Off, $V_{IN} = 48\text{V}$ ,<br>$V_{ISP} = V_{ISN} = 36\text{V}$ , $V_{LEDxx} = 24\text{V}$                                       |             |                      | 0.2                | $\mu\text{A}$  |               |
| $I_{LED}$                          | LED Constant Sink Current  | $V_{ISP} = V_{ISN} = 5\text{V}$ , $V_{LEDxx} = 1\text{V}$<br>REG <sub>DC</sub> = 0x00<br>REG <sub>DC</sub> = 0x20<br>REG <sub>DC</sub> = 0x3F | ●<br>●<br>● | 23.3<br>25.3<br>27.3 | 27.3<br>53.5<br>78 | mA<br>mA<br>mA |               |
| $\Delta I_{LEDC}$                  | Current Mismatch Between Channels  | $V_{ISP} = V_{ISN} = 5\text{V}$ , $V_{LEDxx} = 1\text{V}$ ,<br>REG <sub>DC</sub> = 0x20 (Note 6)  | ●           | $\pm 1$              | $\pm 4$            | %              |               |
| $\Delta I_{LEDD}$                  | Current Mismatch Between Devices   | $V_{ISP} = V_{ISN} = 5\text{V}$ , $V_{LEDxx} = 1\text{V}$ ,<br>REG <sub>DC</sub> = 0x20 (Note 7)  | ●           | $\pm 1$              | $\pm 3$            | %              |               |
| $\Delta I_{LINE}$                  | LED Current Line Regulation  | $V_{ISP} = V_{ISN} = 5\text{V}$ , $V_{LEDxx} = 1\text{V}$ ,<br>REG <sub>DC</sub> = 0x20, $V_{CC} = 3\text{V}$ to $3.6\text{V}$ (Note 8)       |             | 0.1                  | 0.2                | %/V            |               |
| $\Delta I_{LOAD}$                  | LED Current Load Regulation  | $V_{ISP} = V_{ISN} = 5\text{V}$ , REG <sub>DC</sub> = 0x20,<br>$V_{LEDxx} = 1\text{V}$ to $3\text{V}$ (Note 9)                                |             | 0.1                  | 0.2                | %/V            |               |
| $V_{OPEN}$                         | Open LED Threshold   | $V_{ISP} = V_{ISN} = 5\text{V}$ , $V_{LEDxx}$ Falling   |             | 0.35                 |                    | V              |               |
| $V_{SHT}$                          | Short LED Threshold  | $V_{ISP} = V_{ISN} = 5\text{V}$ , $V_{LEDxx}$ Rising  |             | 3.7                  | 3.9                | 4.1            | V             |
| $t_{LEDON}$                        | Minimum LED On-Time  | $V_{ISP} = V_{ISN} = 5\text{V}$ , REG <sub>GS</sub> = 0x001   |             | 0.5                  |                    | $\mu\text{s}$  |               |
| <b>Thermal Protection</b>          |  |   |             |                      |                    |                |               |
| $I_{TSET}$                         | $T_{SET}$ Output Current   | $V_{TSET} = 1\text{V}$  | ●           | 19.0                 | 19.8               | 20.6           | $\mu\text{A}$ |
|                                    | $T_{SET}$ Over Temperature Threshold   | $T_A = 25^\circ\text{C}$  |             |                      | 510                | mV             |               |
| <b>Serial Data Interface</b>       |  |   |             |                      |                    |                |               |
| $V_{SIH}$<br>$V_{SIL}$             | Single-Ended Input (Note 10)<br>High Level Voltage<br>Low Level Voltage        | $V_{CC} = 3\text{V}$ to $3.6\text{V}$   |             | 2.4<br>0             | $V_{CC}$<br>0.6    | V<br>V         |               |
| $I_{SI}$                           | Single-Ended Input Current   | $V_{CC} = 3\text{V}$ to $3.6\text{V}$ , $SI = V_{CC}$ or GND  |             | -0.2                 | 0.2                | $\mu\text{A}$  |               |
| $V_{CM}$<br>$V_{DTH}$<br>$V_{DTL}$ | Differential Input (Note 11)<br>Common Mode<br>High Threshold<br>Low Threshold | $V_{CC} = 3\text{V}$ to $3.6\text{V}$<br>$V_{ID} = 200\text{mV}$<br>$V_{CM} = 1.2\text{V}$<br>$V_{CM} = 1.2\text{V}$                          |             | 0.1<br>-100          | 2.3<br>-50         | V<br>mV<br>mV  |               |
| $I_{DI}$                           | Differential Input Current   | $V_{CC} = 3.6\text{V}$ ; $DI^+$ , $DI^- = 2.4\text{V}$ or $0\text{V}$   |             | -0.2                 | 0.2                | $\mu\text{A}$  |               |
| $V_{OD}$                           | Differential Output Voltage (Note 11)  | $R_L = 100\Omega$   |             | 230                  | 330                | 430            | mV            |
| $\Delta V_{OD}$                    | $V_{OD}$ Magnitude Change Between Complementary Outputs                        | $R_L = 100\Omega$   |             |                      | 1                  | 10             | mV            |
| $V_{OS}$                           | Differential Output Offset Voltage   | $R_L = 100\Omega$   |             | 1.1                  | 1.2                | 1.3            | V             |
| $\Delta V_{OS}$                    | $V_{OS}$ Magnitude Change Between Complementary Outputs                        | $R_L = 100\Omega$   |             |                      | 1                  | 10             | mV            |
| $I_{OSD}$                          | Differential Output Short-Circuit Current                                      | $DO^+ = 0\text{V}$ or $DO^- = 0\text{V}$  |             |                      | -6                 | -8             | mA            |

**TIMING CHARACTERISTICS** The ● denotes the specifications which apply over the full operating temperature range, otherwise specifications are at  $T_A = 25^\circ\text{C}$ .  $V_{IN} = 12\text{V}$ ,  $V_{CC} = 3\text{V}$  to  $3.6\text{V}$ ,  $V_{EN/UVLO} = 1.5\text{V}$ ,  $V_{FB} = 1.5\text{V}$ ,  $V_{ISP} = V_{ISN} = 5\text{V}$ ,  $V_{LEDxx} = 1\text{V}$ ,  $R_T = 105\text{k}$ ,  $R_{ISET} = 60.4\text{k}$ ,  $C_{CAP} = 0.47\mu\text{F}$  to  $V_{IN}$ ,  $C_{SCKO+}/SCKO- = C_{SDO+}/SDO- = 15\text{pF}$ , unless otherwise noted.

| SYMBOL                 | PARAMETER                             | CONDITIONS  | MIN | TYP | MAX | UNITS |    |
|------------------------|---------------------------------------|---|-----|-----|-----|-------|----|
| $f_{SCKI}$             | Data Shift Clock Frequency            |   | ●   |     | 30  | MHz   |    |
| $f_{PWMCK}$            | PWMCK Clock Frequency                 |   | ●   |     | 25  | MHz   |    |
| $t_{WH-CKI}$           | SCKI Pulse Duration                   | SCKI = H (Figure 3)   | ●   | 16  |     | ns    |    |
| $t_{WL-CKI}$           |                                       | SCKI = L (Figure 3)   | ●   | 16  |     | ns    |    |
| $t_{WH-PWM}$           | PWMCK Pulse Duration                  | PWMCK = H (Figure 4)  | ●   | 20  |     | ns    |    |
| $t_{WL-PWM}$           |                                       | PWMCK = L (Figure 4)  | ●   | 20  |     | ns    |    |
| $t_{WH-LDI}$           | LDI Pulse Duration                    | LDI = H (Figure 3)  | ●   | 20  |     | ns    |    |
| $t_{SU-SDI}$           | SDI-SCKI Setup Time                   | SDI – SCKI↑ (Figure 3)  | ●   | 5   |     | ns    |    |
| $t_{HD-SDI}$           | SCKI-SDI Hold Time                    | SCKI↑ – SDI (Figure 3)  | ●   | 5   |     | ns    |    |
| $t_{SU-LDI}$           | SCKI-LDI Setup Time                   | SCKI↓ – LDI↑ (Figure 3)   | ●   | 5   |     | ns    |    |
| $t_{HD-LDI}$           | LDI-SCKI Hold Time                    | LDI↓ – SCKI↑ (Figure 3)   | ●   | 15  |     | ns    |    |
| $t_{PD-SCK\uparrow}$   | SCKI-SCKO Propagation Delay (Rising)  | SCKI↑ – SCKO↑ (Figure 3)  | ●   | 33  | 50  | ns    |    |
| $t_{PD-SCK\downarrow}$ | SCKI-SCKO Propagation Delay (Falling) | SCKI↓ – SCKO↓ (Figure 3)  | ●   | 33  | 50  | ns    |    |
| $\Delta t_{PD-SCK}$    | SCK Duty Cycle Change                 | $\Delta t_{PD-SCK} = t_{PD-SCK\uparrow} - t_{PD-SCK\downarrow}$ |     | 0   |     | ns    |    |
| $t_{PD-SD}$            | SCKO-SDO Propagation Delay            | SCKO↑ – SDO (Figure 3)  | ●   | 2   | 5   | 8     | ns |
| $t_{PD-PWM}$           | PWMCK-LED Propagation Delay           | PWMCK↑ – $I_{LED}$ (Figure 4)                                   |     | 55  |     | ns    |    |
| $t_{R-SO}$             | SCKO/SDO Rise Time                    | $C_{LOAD} = 15\text{pF}$ , 10% to 90%                           |     | 2.6 |     | ns    |    |
| $t_{F-SO}$             | SCKO/SDO Fall Time                    | $C_{LOAD} = 15\text{pF}$ , 90% to 10%                           |     | 2.6 |     | ns    |    |

**Table 1. Test Parameter Equations**

|   |     |
|---|-----|
| $\Delta I_{LEDC}(\%) = \frac{I_{OUTmax(0-15)} - I_{OUTmin(0-15)}}{2 \cdot I_{OUTavg(0-15)}} \cdot 100$  | (1) |
| $\Delta I_{LEDD}(\%) = \frac{I_{OUTavg(0-15)} - I_{OUTcal}}{I_{OUTcal}} \cdot 100$  | (2) |
| $I_{OUTcal} = 2500 \cdot \left( \frac{1.205\text{V}}{R_{ISET}} \right)$   | (3) |
| $\Delta I_{LINE}(\% / V) = \frac{I_{OUTn}  _{V_{CC} = 3.6\text{V}} - I_{OUTn}  _{V_{CC} = 3\text{V}}}{I_{OUTn}  _{V_{CC} = 3\text{V}}} \cdot \frac{100}{0.6\text{V}}$   | (4) |
| $\Delta I_{LOAD}(\% / V) = \frac{I_{OUTn}  _{V_{OUTn} = 3\text{V}} - I_{OUTn}  _{V_{OUTn} = 1\text{V}}}{I_{OUTn}  _{V_{OUTn} = 1\text{V}}} \cdot \frac{100}{2\text{V}}$ | (5) |

|  |     |
|--|-----|
| $V_{ID} =  V(DI^+) - V(DI^-) $         | (6) |
| $V_{CM} = \frac{V(DI^+) + V(DI^-)}{2}$ | (7) |
| $V_{OD} =  V(DO^+) - V(DO^-) $         | (8) |
| $V_{OS} = \frac{V(DO^+) + V(DO^-)}{2}$ | (9) |

## ELECTRICAL CHARACTERISTICS

**Note 1:** Stresses beyond those listed under Absolute Maximum Ratings may cause permanent damage to the device. Exposure to any Absolute Maximum Rating condition for extended periods may affect device reliability and lifetime.

**Note 2:** The LT3745E-1 is guaranteed to meet performance specifications from 0°C to 125°C junction temperature. Specifications over the -40°C to 125°C operating junction temperature range are assured by design, characterization and correlation with statistical process controls. The LT3745I-1 is guaranteed over the full -40°C to 125°C operating junction temperature range.

**Note 3:** This IC includes thermal shutdown protection that is intended to protect the device during momentary overload conditions. Junction temperature will exceed 125°C when thermal shutdown protection is active. Continuous operation above the specified maximum operating junction temperature may impair device reliability.

**Note 4:** The  $V_{CC}$  supply current with LED channel on highly depends on the LED current setting and LEDxx pin voltage; its test condition is  $R_{ISET} = 60.4k$ ,  $REG_{DC} = 0x3F$ ,  $REG_{GS} = 0xFFFF$ ,  $V_{ISP} = V_{ISN} = 5V$ ,  $V_{LEDxx} = 1V$ . The  $V_{CC}$  supply current with serial data interface on highly depends on  $V_{CC}$  supply voltage,  $SCKI^+/SCKI^-$  clock frequency,  $SCKO^+/SCKO^-$ ,  $SDO^+/SDO^-$  loading capacitance, and  $PWMCK^+/PWMCK^-$  clock frequency; its test condition is  $V_{CC} = 3.3V$ ,  $f_{SCKI^+/SCKI^-} = 30MHz$ ,  $C_{SCKO^+/SCKO^-} = C_{SDO^+/SDO^-} = 15pF$ ,  $f_{PWMCK^+/PWMCK^-} = 409.6KHz$ .

**Note 5:** The SYNC frequency must be higher than the RT programmed oscillator frequency, and is suggested to be around 20% higher. Any SYNC frequency higher than the suggested value may introduce sub-harmonic oscillation in the converter due to insufficient slope compensation. See Application Information section.

**Note 6:** The current mismatch between channels is calculated as Equation 1 in Table 1.

**Note 7:** The current mismatch between devices is calculated as Equations 2 and 3 in Table 1.

**Note 8:** The LED current line regulation is calculated as Equation 4 in Table 1.

**Note 9:** The LED current load regulation is calculated as Equation 5 in Table 1.

**Note 10:** The specifications of single-ended input SI apply to the LDI pin.

**Note 11:** The specifications of differential inputs  $DI^+/DI^-$  apply to  $SCKI^+/SCKI^-$ ,  $SDI^+/SDI^-$  and  $PWMCK^+/PWMCK^-$ ; the specifications of differential outputs  $DO^+/DO^-$  apply to  $SCKO^+/SCKO^-$  and  $SDO^+/SDO^-$ . The parameters  $V_{ID}$ ,  $V_{CM}$ ,  $V_{OD}$  and  $V_{OS}$  are defined in Equations 6 to 9 and measured in the Parameter Test Setup.

Parameter Test Setup

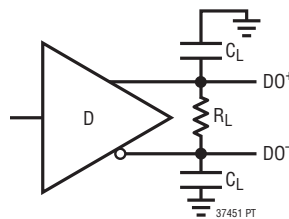

**TYPICAL PERFORMANCE CHARACTERISTICS**  $T_A = 25^\circ\text{C}$ , unless otherwise noted.

**100Hz 8:1 GS Dimming**

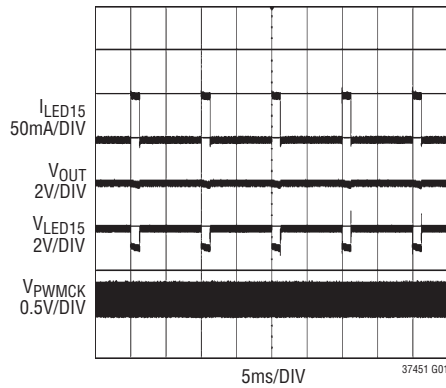

CIRCUIT OF FIGURE 7:  
DC<sub>15</sub> = 0x20  
GS<sub>15</sub> = 0x200

**100Hz 4096:1 GS Dimming**

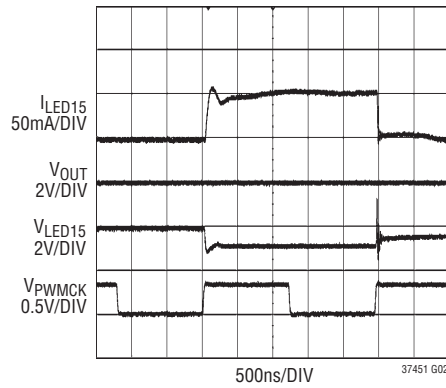

CIRCUIT OF FIGURE 7:  
DC<sub>15</sub> = 0x20  
GS<sub>15</sub> = 0x001

**500Hz 4096:1 GS Dimming**

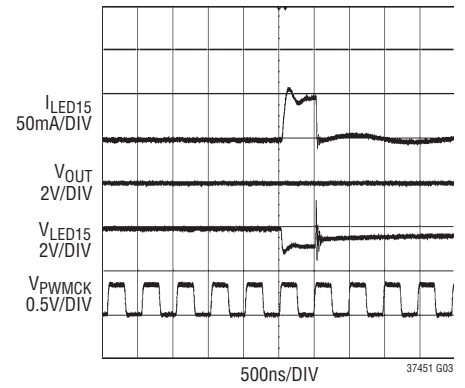

CIRCUIT OF FIGURE 7:  
DC<sub>15</sub> = 0x20  
GS<sub>15</sub> = 0x001

**200Hz 2-Level DC Dimming**

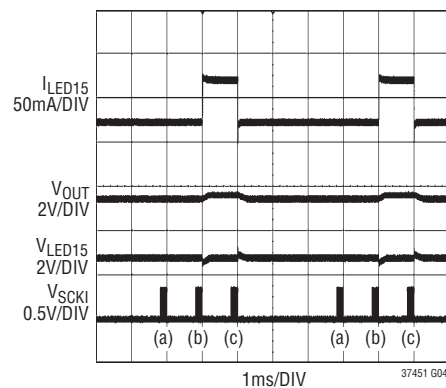

CIRCUIT OF FIGURE 7:  
(a) EN = 1, GS<sub>15</sub> = 0xFFF (c) EN = 1, DC<sub>15</sub> = 0x00  
(b) EN = 1, DC<sub>15</sub> = 0x3F

**200Hz 4-Level DC Dimming**

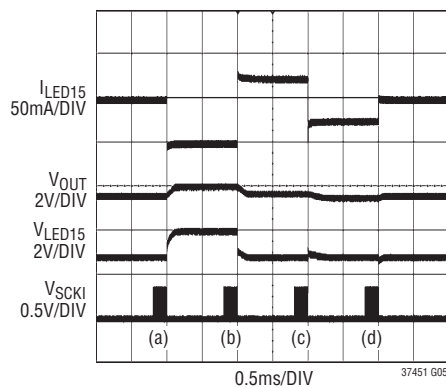

CIRCUIT OF FIGURE 7:  
(a) EN = 0, GS<sub>15</sub> = 0xFFF (c) EN = 1, DC<sub>15</sub> = 0x00  
(b) EN = 1, DC<sub>15</sub> = 0x3F (d) EN = 1, DC<sub>15</sub> = 0x20

**Adaptive LED Bus Voltage I**

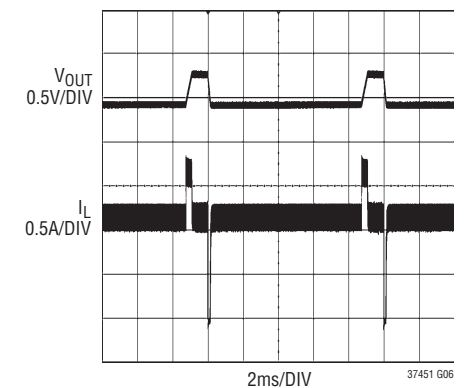

CIRCUIT OF FIGURE 7:  
DC<sub>00-15</sub> = 0x3F, GS<sub>00-15</sub> = 0xFFF

**Adaptive LED Bus Voltage II**

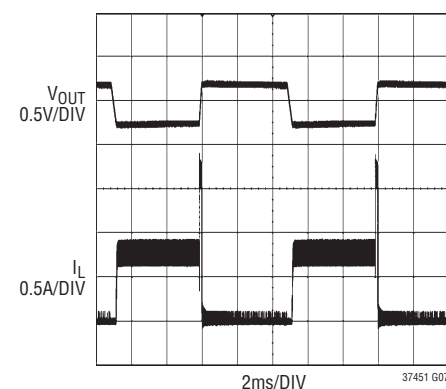

CIRCUIT OF FIGURE 7:  
DC<sub>00-15</sub> = 0x20, GS<sub>00-15</sub> = 0x800

**Adaptive LED Bus Voltage III**

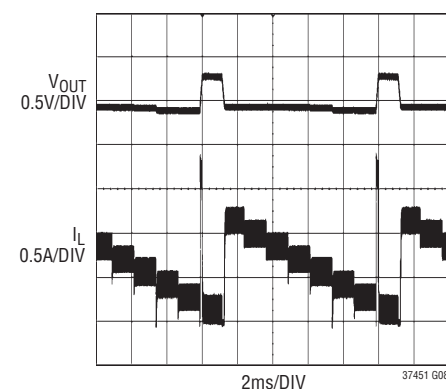

CIRCUIT OF FIGURE 7:  
DC<sub>00-15</sub> = 0x3F, GS<sub>00-01</sub> = 0x1FF, GS<sub>02-03</sub> = 0x3FF,  
GS<sub>04-05</sub> = 0x5FF, GS<sub>06-07</sub> = 0x7FF, GS<sub>08-09</sub> = 0x9FF,  
GS<sub>10-11</sub> = 0xBFF, GS<sub>12-13</sub> = 0xDFF, GS<sub>14-15</sub> = 0xFFF

**Adaptive LED Bus Voltage IV**

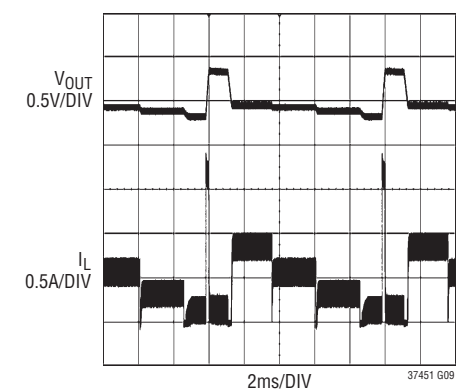

CIRCUIT OF FIGURE 7:  
DC<sub>00-03</sub> = 0x3F, GS<sub>00-03</sub> = 0x3FF, DC<sub>04-07</sub> = 0x2F,  
GS<sub>04-07</sub> = 0x7FF, DC<sub>08-11</sub> = 0x1F, GS<sub>08-11</sub> = 0xBFF,  
DC<sub>12-15</sub> = 0x0F, GS<sub>12-15</sub> = 0xFFF

## TYPICAL PERFORMANCE CHARACTERISTICS $T_A = 25^\circ\text{C}$ , unless otherwise noted.

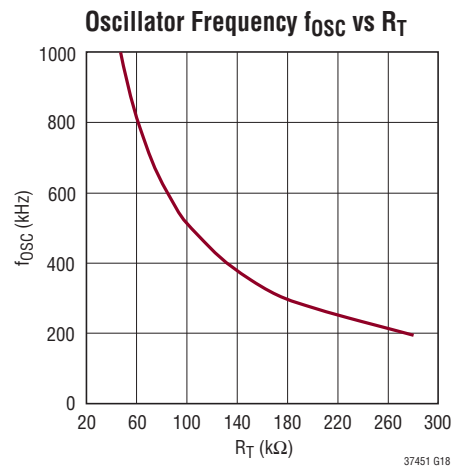
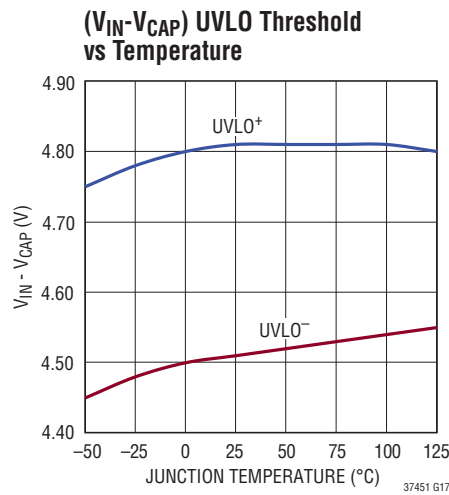
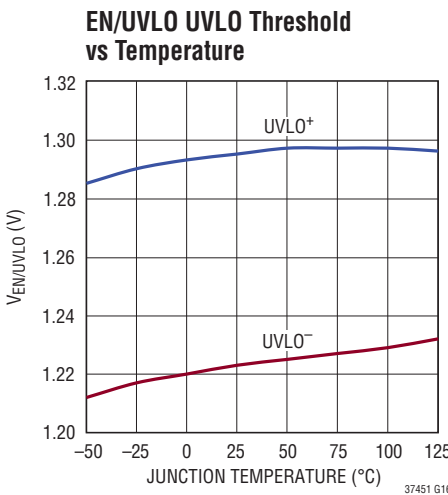
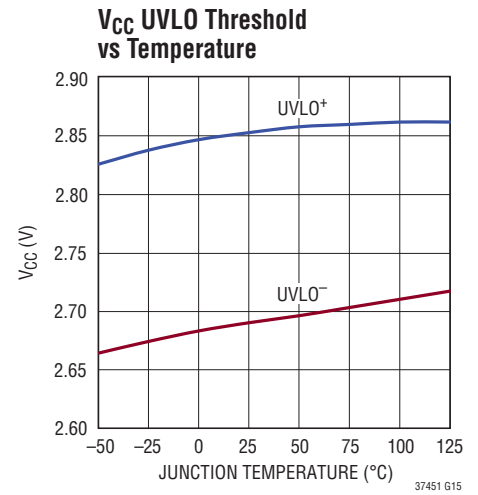
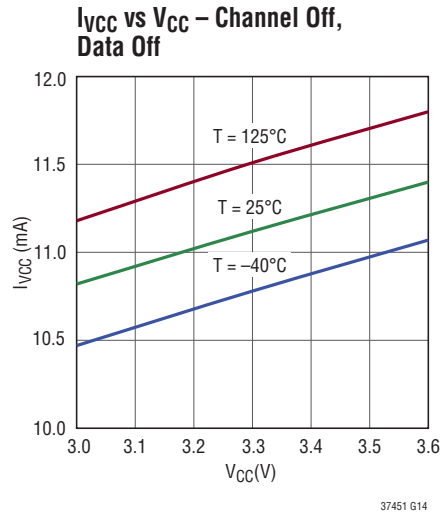
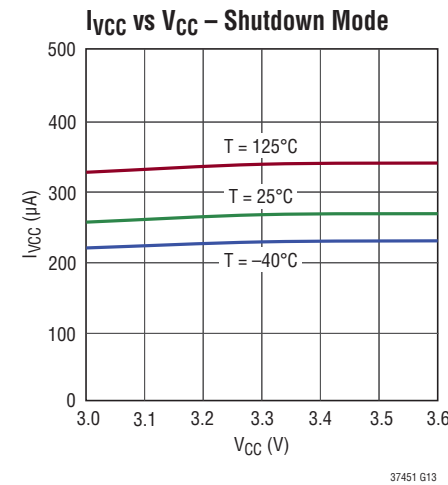
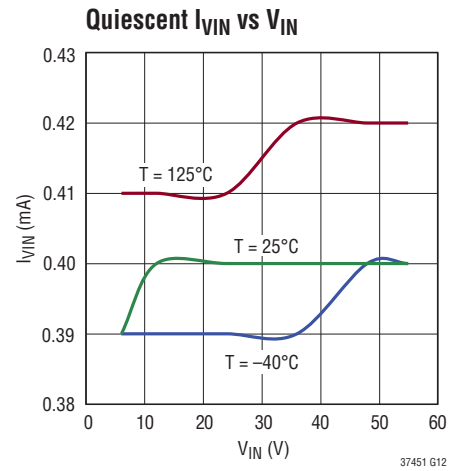
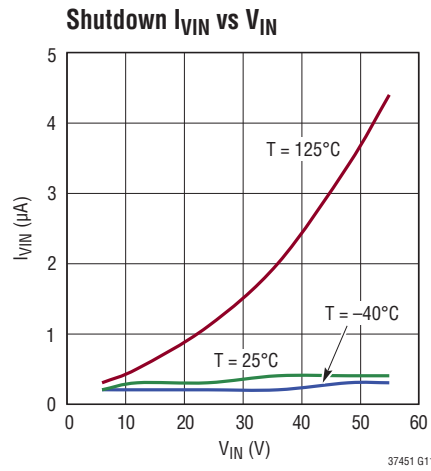
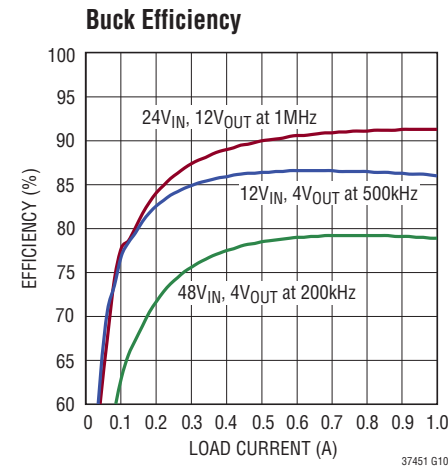



**TYPICAL PERFORMANCE CHARACTERISTICS**

$T_A = 25^\circ\text{C}$ , unless otherwise noted.

**Oscillator Frequency  $f_{osc}$  vs Temperature**

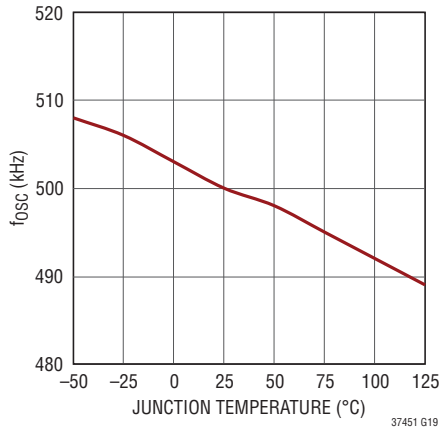

37451 G19

**FB Regulation Voltage vs Load Current**

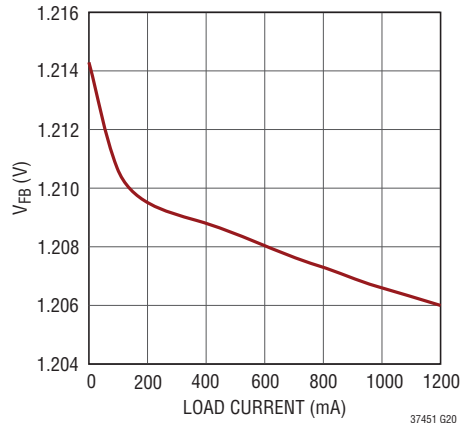

37451 G20

**LED Regulation Voltage vs Load Current**

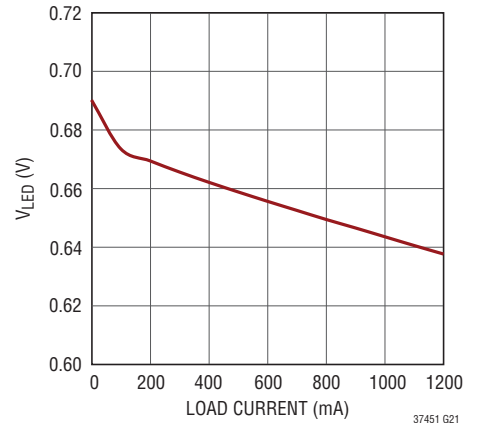

37451 G21

**Soft-Start Charge Current  $I_{SS}$  vs Temperature**

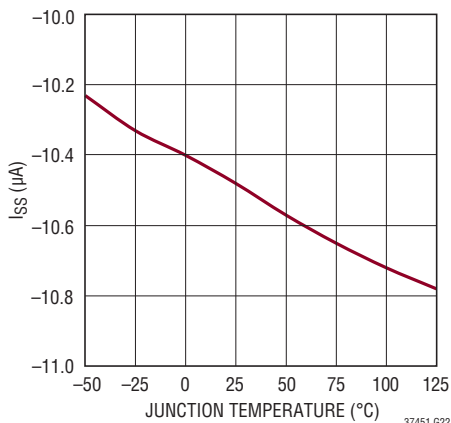

37451 G22

**Current Sense Threshold vs  $V_{ISN}$**

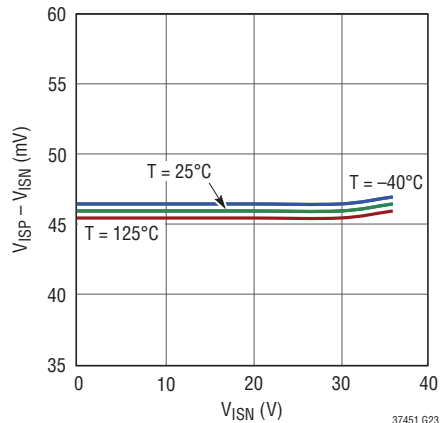

37451 G23

**CAP Bias Voltage ( $V_{IN} - V_{CAP}$ ) vs  $V_{IN}$**

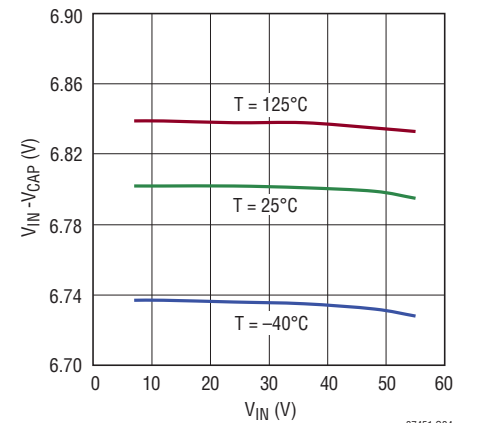

37451 G24

**CAP Bias Voltage ( $V_{IN} - V_{CAP}$ ) vs  $I_{CAP}$**

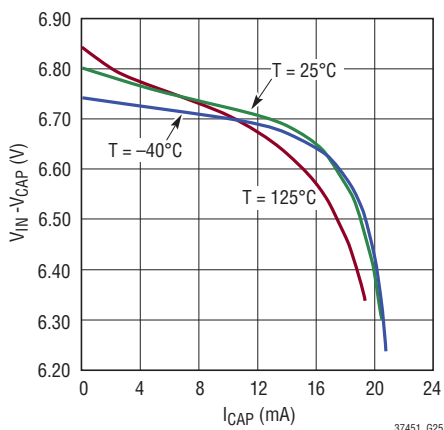

37451 G25

**$V_{ISET}$  Pin Voltage vs Temperature**

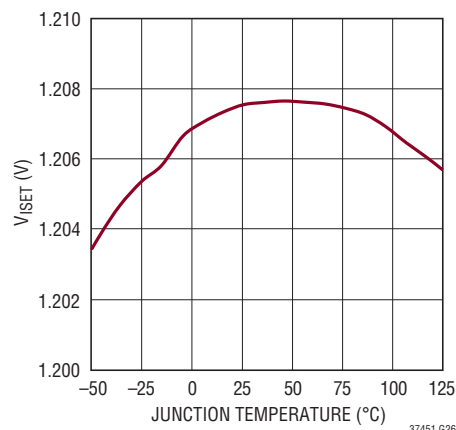

37451 G26

## TYPICAL PERFORMANCE CHARACTERISTICS $T_A = 25^\circ\text{C}$ , unless otherwise noted.

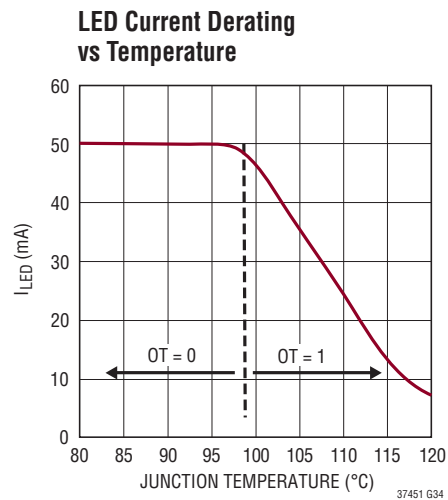
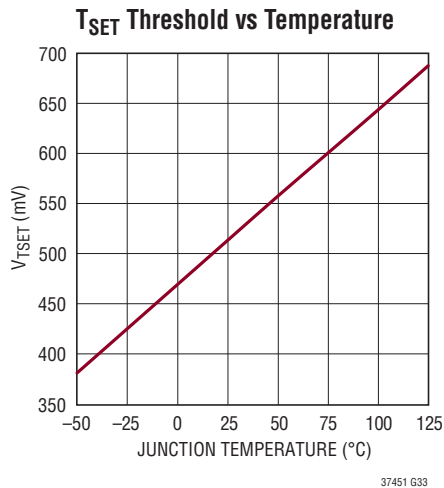
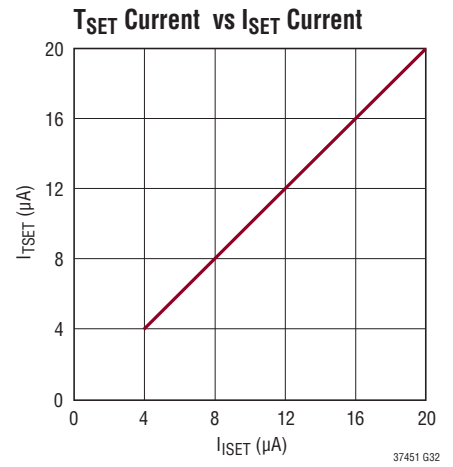
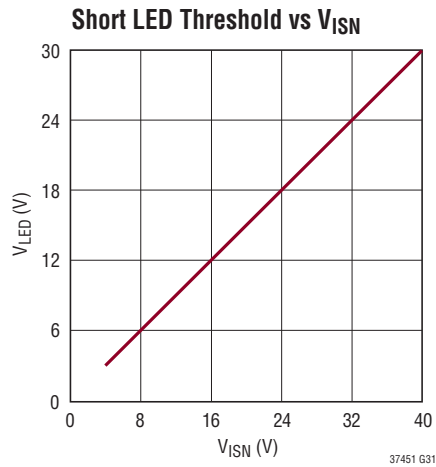
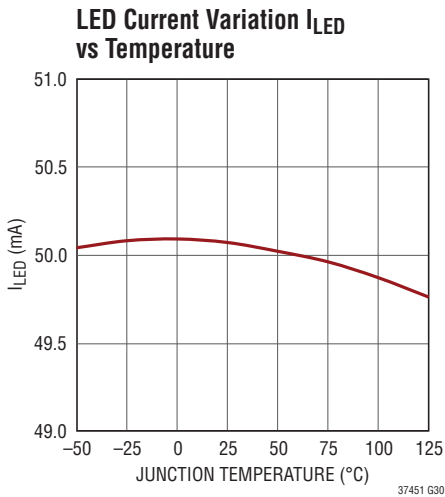
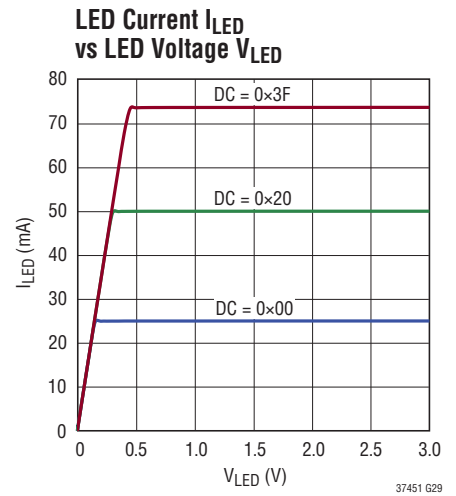
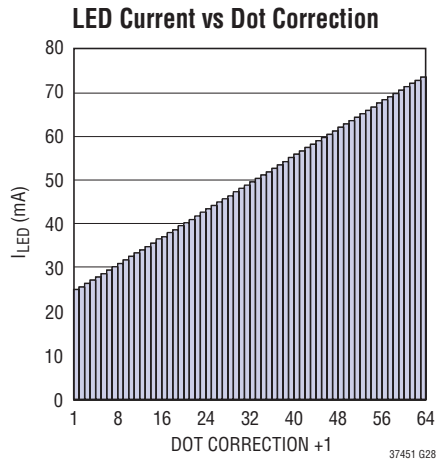
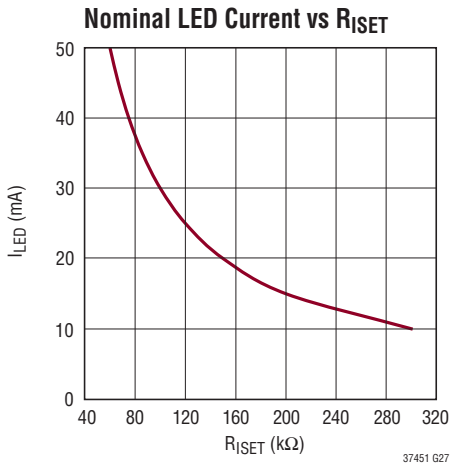

## PIN FUNCTIONS

**EN/UVLO (Pin 1):** Enable and Undervoltage Lockout (UVLO) Pin. The pin can accept a digital input signal to enable or disable the chip. Tie to 0.35V or lower to shut down the chip or tie to 1.34V or higher for normal operation. This pin can also be connected to  $V_{IN}$  through a resistor divider to program a power input UVLO threshold. If both the enable and UVLO functions are not used, tie this pin to  $V_{CC}$  pin.

**LED00 to LED15 (Pins 2 to 9, 22 to 29):** LED Driver Output Pins. Connect the cathodes of LED strings to these pins.

**SCKI<sup>-</sup>, SCKI<sup>+</sup> (Pins 10, 11):** Serial Interface LVDS Logic Clock Input Pins.

**SDI<sup>-</sup>, SDI<sup>+</sup> (Pins 12, 13):** Serial Interface LVDS Logic Data Input Pins.

**LDI (Pin 14):** Serial Interface TTL/CMOS Logic Latch Input Pin. An asynchronous input signal at this pin latches the serial data in the shift registers into the proper registers and the status information is ready to shift out with the coming clock pulses. See more details in the Operation section.

**$V_{CC}$  (Pin 15):** Logic and Control Supply Pin. The pin powers serial data interface and internal control circuitry. Must be locally bypassed with a capacitor to ground.

**PWMCK<sup>+</sup>, PWMCK<sup>-</sup> (Pins 16, 17):** Grayscale PWM Dimming LVDS Logic Clock Input Pins. Individual PWM dimming signal is generated by counting this clock pulse from zero to the bits in its 12-bit grayscale PWM register.

**SDO<sup>+</sup>, SDO<sup>-</sup> (Pins 18, 19):** Serial Interface LVDS Logic Data Output Pins.

**SCKO<sup>+</sup>, SCKO<sup>-</sup> (Pins 20, 21):** Serial Interface LVDS Logic Clock Output Pins.

**SYNC (Pin 30):** Switching Frequency Synchronization Pin. Synchronizes the internal oscillator frequency to an external clock applied to the SYNC pin. The SYNC pin is TTL/CMOS logic compatible. Tie to ground or  $V_{CC}$  if not used.

**RT (Pin 31):** Timing Resistor Pin. Programs the switching frequency from 200kHz to 1MHz. See Table 2 for the recommended  $R_T$  values for common switching frequencies.

**SS (Pin 32):** Soft-Start Pin. Placing a capacitor here programs soft-start timing to limit inductor inrush current during start-up. The soft-start cycle will not begin until all the  $V_{CC}$ , EN/UVLO, and ( $V_{IN}-V_{CAP}$ ) voltages are higher than their respective UVLO thresholds.

**FB (Pin 33):** Feedback Pin. The pin is regulated to the internal bang-gap reference 1.210V during start-up and precharging phases. Connect to a resistor divider from the buck converter output to program the maximum LED bus voltage. See more details in the Applications Information section.

**ISN (Pin 34):** Negative Inductor Current Sense Pin. The pin is connected to one terminal of the external inductor current sensing resistor and the buck converter output supplying parallel LED channels.

**ISP (Pin 35):** Positive Inductor Current Sense Pin. The pin is connected to the inductor and the other terminal of the external inductor current sensing resistor.

**CAP (Pin 36):**  $V_{IN}$  Referenced Regulator Supply Capacitor Pin. The pin holds the negative terminal of an internal  $V_{IN}$  referenced 6.8V linear regulator used to bias the gate driver circuitry. Must be locally bypassed with a capacitor to  $V_{IN}$ .

**GATE (Pin 37):** Gate Driver Pin. The pin drives an external P-channel power MOSFET with a typical peak current of 1A. Connect this pin to the gate of the power MOSFET with a short and wide PCB trace to minimize trace inductance.

**$V_{IN}$  (Pin 38):** Power Input Supply Pin. Must be locally bypassed with a capacitor to ground.

**$T_{SET}$  (Pin 39):** Temperature Threshold Setting Pin. A resistor to ground programs overtemperature threshold. See more details in the Applications Information section.

**$I_{SET}$  (Pin 40):** Nominal LED Current Setting Pin. A resistor to ground programs the nominal LED current for all the channels. See more details in the Applications Information section.

**GND (Exposed Pad Pin 41):** Ground Pin. Must be soldered to a continuous copper ground plane to reduce die temperature and to increase the power capability of the device.

**BLOCK DIAGRAM**

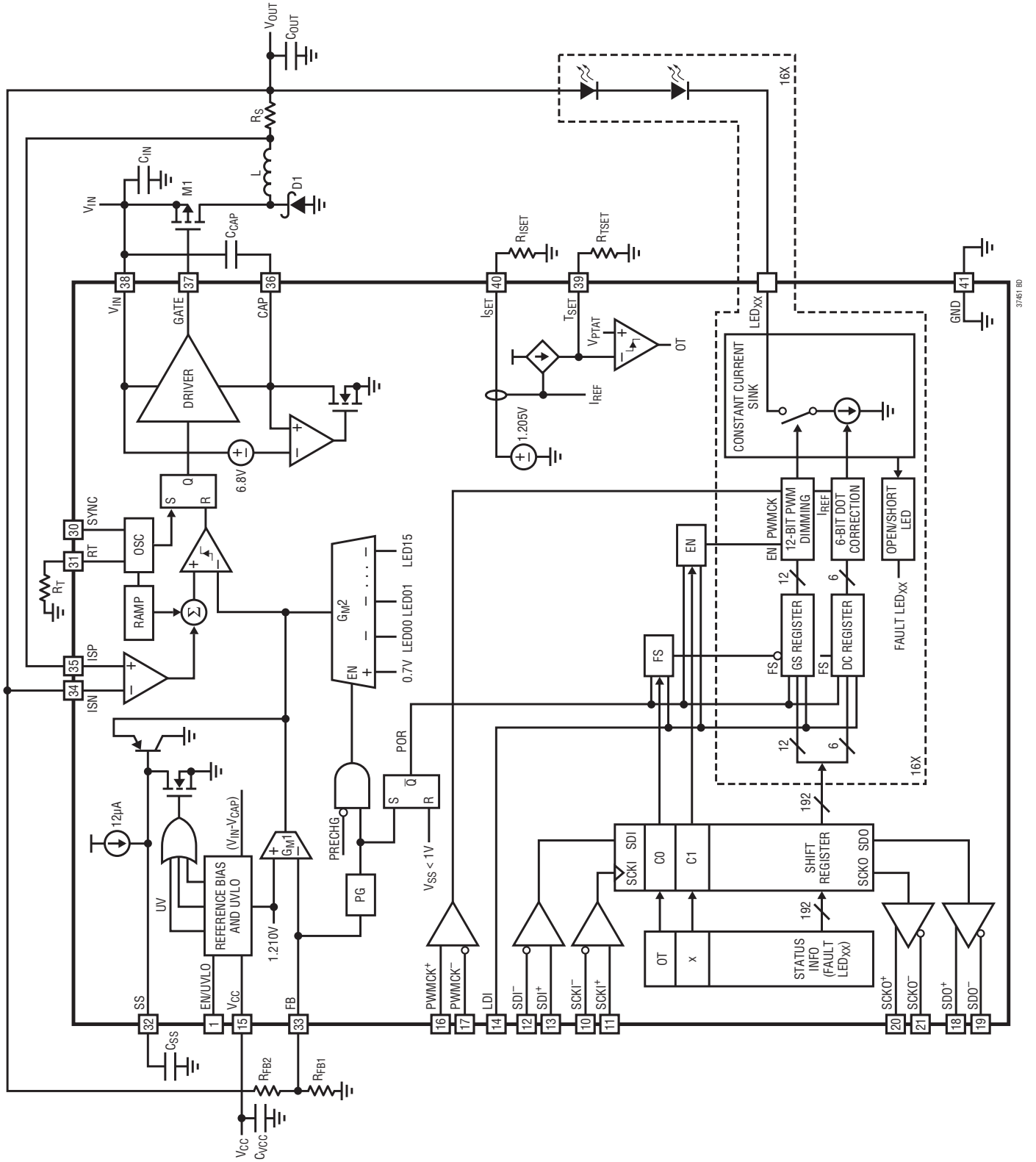

37451 BD

## OPERATION

The LT3745-1 integrates a single constant-frequency current-mode nonsynchronous buck controller with sixteen linear current sinks. The buck controller generates an adaptive output LED bus voltage to supply parallel LED strings and the sixteen linear current sinks regulate and modulate individual LED strings. Its operation is best understood by referring to the Block Diagram.

### Start-Up

The LT3745-1 enters shutdown mode when the EN/UVLO pin is lower than 0.35V. Once the EN/UVLO pin is above 0.35V, the part starts to wake up internal bias currents, generate various references, and charge the capacitor  $C_{CAP}$  towards 6.8V regulation voltage. This  $V_{IN}$  referenced voltage regulator ( $V_{IN} - V_{CAP}$ ) will supply the internal gate driver circuitry driving an external P-channel MOSFET in normal operation. The LT3745-1 remains in undervoltage lockout (UVLO) mode as long as any one of the EN/UVLO,  $V_{CC}$ , and ( $V_{IN} - V_{CAP}$ ) UVLO flags is high. Their UVLO thresholds are typically 1.30V, 2.86V, and 4.9V, respectively. After all the UVLO flags are cleared, the buck controller starts to switch, and the soft-start SS pin is released and charged by a 12 $\mu$ A current source, thereby smoothly ramping up the inductor current and the output LED bus voltage.

### Power-on-Reset (POR)

During start-up, an internal power-on-reset (POR) high signal blocks the input signals to the serial data interface and resets all the internal registers except the 194-bit shift register. The 1-bit frame select (FS) register, 1-bit enable LED channel (EN) register, individual 12-bit grayscale (GS) registers, and individual 6-bit dot correction (DC) registers are all reset to zero. Thus all the LED channels are turned off initially with the default grayscale (0x000) and dot correction (0x00) setting. Once the part completes its soft-start (i.e., the SS pin voltage is higher than 1V) and the output LED bus voltage is power good (i.e., within 5% of its FB programmed regulation level), the POR signal goes low to allow the input signals to the serial data interface. Any fault triggering the soft-start will generate another POR high signal and reset internal registers again.

### LVDS Serial Data Interface

The LT3745-1 has a 30MHz, fully-buffered, cascadable LVDS (low voltage differential signals) serial data interface. Due to the differential signal transmission and the low voltage swing, LVDS delivers the benefits of low noise generation, high noise rejection, and low power consumption for high data rate signals. Therefore, the LT3745-1 uses LVDS logic for SCKI<sup>+</sup>, SCKI<sup>-</sup>, SDI<sup>+</sup>, SDI<sup>-</sup>, SCKO<sup>+</sup>, SCKO<sup>-</sup>, and SDO<sup>+</sup>, SDO<sup>-</sup> signals (high data rate signals), and TTL/CMOS logic for LDI signal (low data rate signal). In this data sheet, the differential signals SCKI<sup>+</sup>, SCKI<sup>-</sup>, SDI<sup>+</sup>, SDI<sup>-</sup>, SCKO<sup>+</sup>, SCKO<sup>-</sup> and SDO<sup>+</sup>, SDO<sup>-</sup> are abbreviated to SCKI, SDI, SCKO and SDO, respectively.

The LT3745-1 can be connected to microcontrollers, digital signal processors (DSPs), or field programmable gate arrays (FPGAs) in two different topologies shown in Figure 1. In topology #1, the LDI signal needs global routing while the SCKI, and SDI signals only need local routing between chips. Each chip provides the SCKO signal along with the SDO signal to drive the next chip. The skew inside the chip between the SCKI and SDI signals is balanced internally. The skew outside the chip between the SCKO and SDO signals can be easily balanced by parallel routing these two pairs of signals between chips. The SDI signal is received with the SCKI signal, and the SDO signal is sent with the SCKO signal. In a low data rate application with a small number of cascaded chips, the topology #1 can be simplified to the topology #2 by ignoring the SCKO outputs.

Figure 2 shows two serial data input SDI frames (GS frame and DC frame) and one serial data output SDO frame (status frame). All the frames have the same 194-bit in length and are transmitted with the MSB first and the LSB last. The SDI frames are sent with the SCKI signal and the SDO frame is received with the SCKO signal. The C0 bit (frame select) determines any SDI frame to be either a GS frame (C0 = 0) or a DC frame (C0 = 1), and the C1 bit (EN) enables (C1 = 1) or disables (C1 = 0) all the LED channels. The status frame reads back the  $T_{SET}$  pin resistor-programmable over-temperature flag and individual open/short LED fault flags, as well as the individual 6-bit DC setting.

**OPERATION**

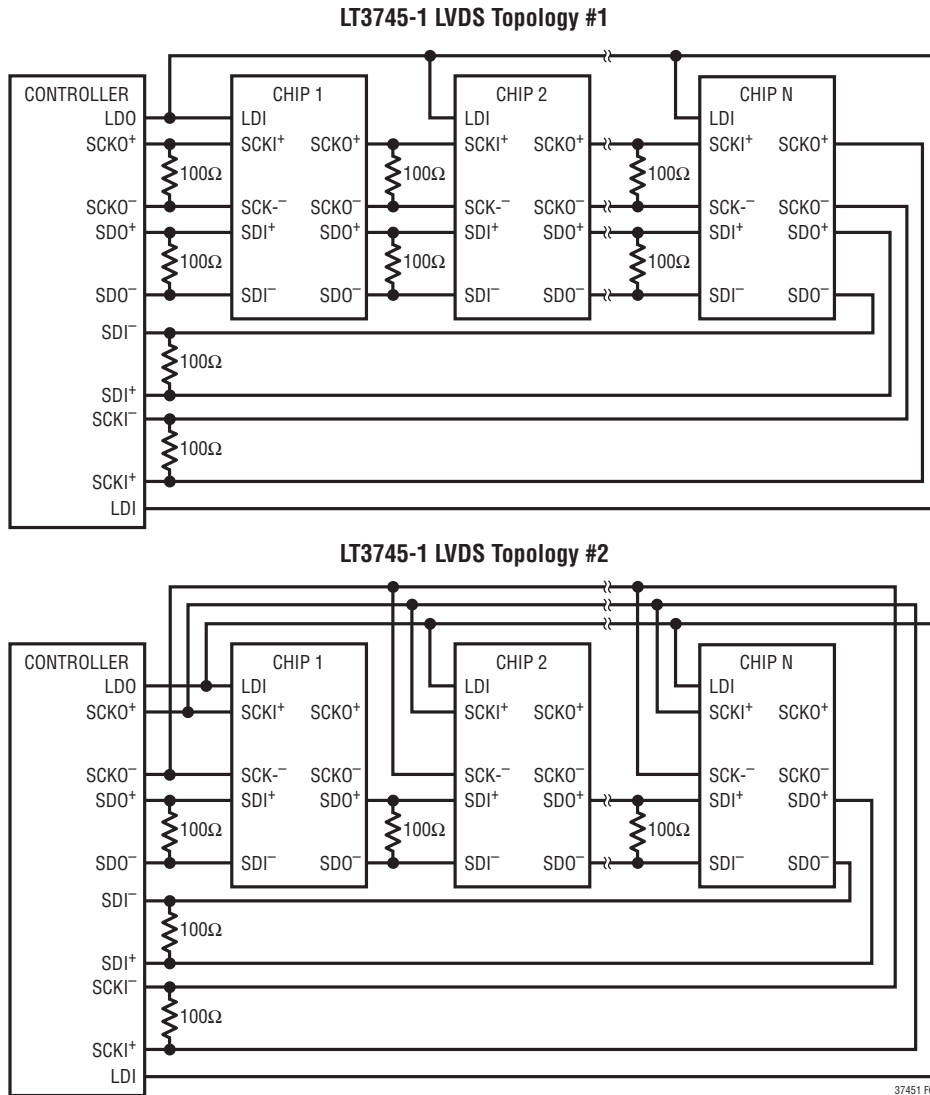

**Figure 1. Two Topologies of the LT3745-1 LVDS Serial Data Interface**

Inside the part, there are one 194-bit shift register SR[0:193], one 1-bit frame select (FS) register, one 1-bit enable LED channel (EN) register, sixteen 12-bit grayscale (GS) registers, sixteen 6-bit dot correction (DC) registers, one 1-bit over temperature (OT) flag register, and sixteen 1-bit LED fault flag registers. The input of the 194-bit shift register, i.e., the input of the first bit SR[0], is connected to the SDI signal. The output of the 194-bit shift register, i.e., the output of the last bit SR[193] is connected to the SDO signal. The SCKI signal shifts the SDI frame (GS or DC frame) in and the SCKO signal shift the SDO frame (status frame) out of the 194-bit shift register with their rising edges. The LDI high signal latches the SDI frame (GS or

DC frame) from the 194-bit shift register into corresponding FS, EN, GS or DC registers, and loads the SDO frame (status frame) from the OT and LED fault flag registers to the 194-bit shift register at the same time. Therefore, a daisy-chain type loop communication with simultaneous writing and reading capability is implemented.

Figure 3 illustrates the timing relation among serial input and serial output signals in more detail. One DC frame followed by another GS frame is sent through the LDI, SCKI, and SDI signals. At the same time, two status frames are received through the SCKO and SDO signals. The rising edges of the SCKI signal shift a frame of 194-bit data at

37451 F01

# OPERATION

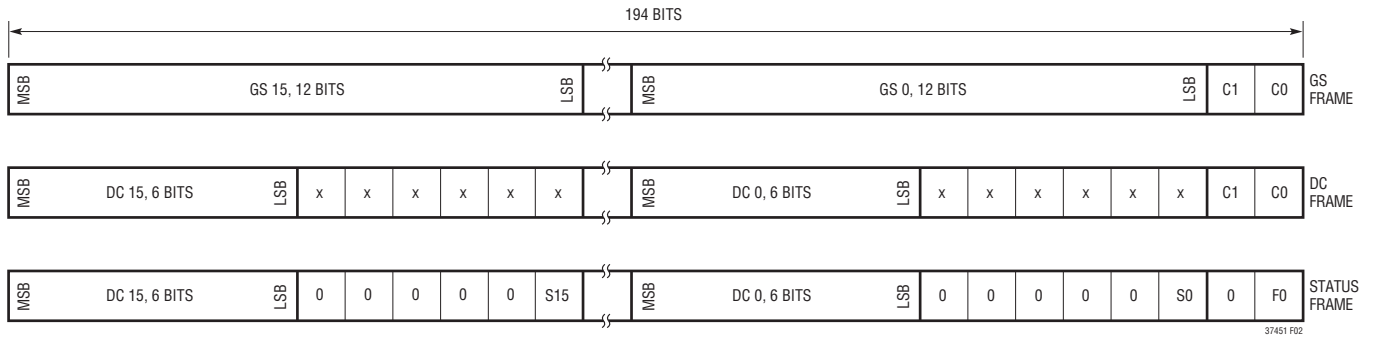

**COMMAND REGISTER:**

C1: ENABLE LED CHANNELS - ENABLE = 1, DISABLE = 0  
 C0: FRAME SELECT - GS FRAME = 0, DC FRAME = 1

**STATUS REGISTER:**

S0-S15: LED 0-15 FAULT - FAULT = 1, OK = 0  
 F0: OT - OVER TEMPERATURE = 1, OK = 0

Figure 2. Serial Data Frame Format

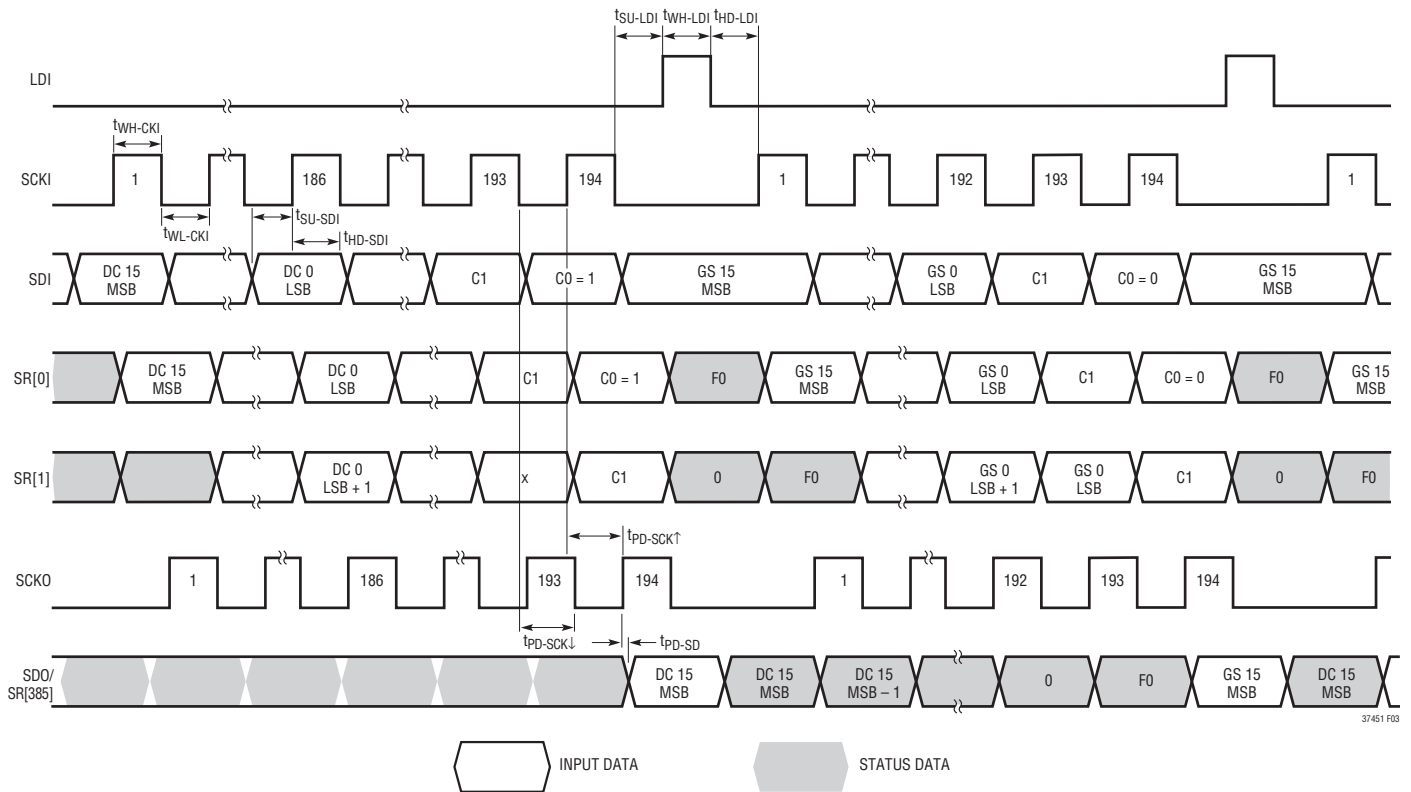

Figure 3. Serial Data Input and Output Timing Chart



## OPERATION

the SDI pins into the 194-bit shift register SR[0:193]. After 194 clock cycles, all the 194-bit data sit in the right place waiting for the LDI signal. An asynchronous LDI high signal latches the 1-bit FS register, 1-bit EN register, and individual 12-bit GS registers (when FS = 0) or 6-bit DC registers (when FS = 1) for each channel. At the same time, a frame of status information, including over temperature flag and individual open/short LED fault flags, is parallel loaded into the 194-bit shift register and will be shifted out with the coming clock cycles.

### Constant Current Sink

Each LED channel has a local constant current sink regulating its own LED current independent of the LED bus voltage  $V_{OUT}$ . The recommended LED pin voltage ranges from 0.8V to 3V. As shown in the Typical Performance Characteristics  $I_{LED}$  vs  $V_{LED}$  curves, the LED current  $I_{LED}$  has the best load regulation when the LED pin voltage  $V_{LED}$  sits above 0.5V. A lower LED bus voltage  $V_{OUT}$  may not regulate all the LED channels across temperature, current, and manufacturing variation, while a higher LED bus voltage  $V_{OUT}$  will force a higher LED pin voltage across the current sink, thereby dissipating more power inside the part. See more details about the choice of the LED bus voltage and the power dissipation calculation in the Application Information section.

### Dot Correction and Grayscale Digital-to-Analog Conversion

The resistor on the  $I_{SET}$  pin programs the nominal LED current (10mA to 50mA) for all the channels. Individual LED channel can be adjusted to a different current setting by its own 6-bit dot correction register. The adjustable LED current ranges from 0.5X to 1.5X of the nominal LED current in 63 linear steps. See more details about setting nominal LED current and dot correction in the Applications Information section.

In addition to the dot correction current adjustment, individual LED channels can also be modulated by their own grayscale PWM dimming signal. To achieve a better performance, all the grayscale PWM dimming signals are synchronized to the same frequency with no phase shift between rising edges. Each constant current sink is enabled

or disabled when its grayscale PWM dimming signal goes high or low. This periodic grayscale PWM dimming signal is generated by its own 12-bit grayscale register with a duty cycle from 0/4096 to 4095/4096 and a period equal to 4096 PWMCK clock cycles.

The generation of the grayscale PWM dimming signal is best understood by referring to Figure 4. The LVDS signals PWMCK<sup>+</sup>, PWMCK<sup>-</sup> are abbreviated to the PWMCK signal. After EN = 1 is set, the first rising edge of the PWMCK signal will increase the internal 12-bit grayscale counter from zero to one and turn on all the LED channels with grayscale value not zero. Each following rising edge of the PWMCK signal increases the grayscale counter by one. Any LED channel will be turned off when its 12-bit grayscale register value is equal to the value in the grayscale counter. To generate a 100% duty cycle for all the grayscale PWM dimming signals, the PWMCK signal can be paused before counting to the value in any individual 12-bit grayscale registers. Setting EN = 0 will reset the grayscale counter to zero and turn off all the LED channels immediately.

### Dual-Loop Analog OR Control

The switching frequency can be programmed from 200kHz to 1MHz with the resistor connected to the RT pin and it can be synchronized to an external clock using the SYNC pin. Each switching cycle starts with the gate driver turning on the external P-channel MOSFET M1 and the inductor current is sampled through the sense resistor  $R_S$  between the ISP and ISN pins. This current is amplified and added to a slope compensation ramp signal, and the resulting sum is fed into the positive terminal of the PWM comparator. When this voltage exceeds the level at the negative terminal of the PWM comparator, the gate driver turns off M1. The level at the negative terminal of the PWM comparator is set by either of two error amplifiers  $G_{M1}$  and  $G_{M2}$ . In this dual-loop analog OR control, the FB loop  $G_{M1}$  regulates the FB pin voltage to 1.205V and the LED loop  $G_{M2}$  regulates the minimum active LED pin voltage (LED00 to LED15) to 0.7V. In the start-up phase, the  $G_{M2}$  is disabled and the output LED bus voltage is regulated towards the feedback resistor programmed LED bus voltage. This FB programmed voltage defines the maximum



## OPERATION

LED bus voltage and should be programmed high enough to supply the worst-case LED string across temperature, current, and manufacturing variation.

### Adaptive-Tracking-Plus-Precharging

Higher system efficiency and faster transient response are two highly anticipated specifications in an individually-modulated multi-channel LED driver chip. The LT3745-1 uses a patent pending adaptive-tracking-plus-precharging technique to achieve both of them simultaneously.

Besides 16 internal grayscale PWM dimming signals, the part also generates another internal precharging signal PRECHG. As shown in Figure 4, the PRECHG signal divides any grayscale PWM dimming cycle into two phases: tracking phase when PRECHG = 0 and precharging phase when PRECHG = 1. During each grayscale PWM dimming cycle – 4096 PWMCK clock cycles, the PRECHG signal stays low for the first 3584 clock cycles (7/8 of the grayscale PWM dimming period) and goes high for the rest 512 clock cycles (1/8 of the grayscale PWM dimming period). In the event of

all the LED channels being not *active* (i.e., either fault or off) before the 3585th PWMCK clock, the PRECHG signal will go high immediately.

To better explain the operation of the adaptive-tracking-plus-precharging technique, a simplified application system with 3-channel LED array is presented in Figure 5. Each channel consists of a single LED with the forward voltage drop equal to 3.1V, 3.5V, and 3.9V, respectively. Three internal grayscale PWM dimming signals PWM1, PWM2, and PWM3 are used to modulate each LED channel.

At the beginning of each grayscale PWM dimming cycle, all three LED channels are turned on and the tracking phase starts with PRECHG = 0. The amplifier  $G_{M2}$  is enabled and takes the control from the amplifier  $G_{M1}$ , regulating the minimum *active* LED pin voltage to 0.7V. With the  $V_{LED3}$  equal to 0.7V, the output LED bus voltage is tracked to 4.6V. Subsequently, at a certain time instant  $t_1$  when the third channel is turned off, the minimum *active* LED pin voltage goes to  $V_{LED2}$ , 1.1V. Then the amplifier  $G_{M2}$  tracks the output LED bus voltage

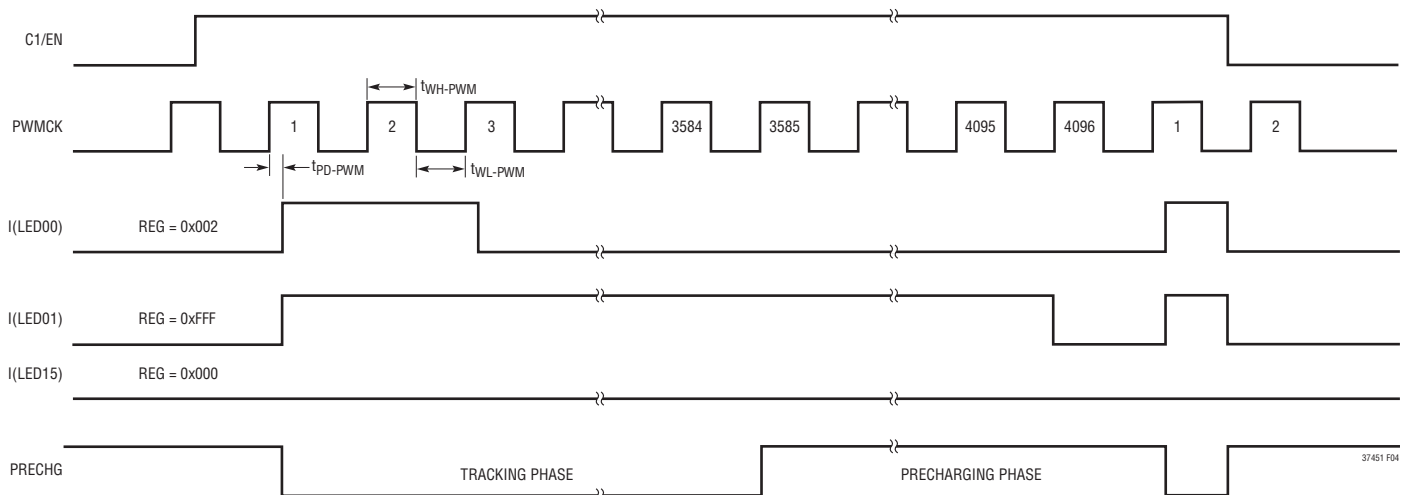

Figure 4. Grayscale PWM Dimming and Precharging Signal Timing Chart

## OPERATION

down to 4.2V to maintain the minimum *active* LED pin voltage equal to 0.7V again. Similarly, at the next time instant  $t_2$ , the output LED bus voltage is tracked down to 3.8V. In this manner, the adaptive-tracking technique eliminates unnecessary power dissipation across the current sinks and yields superior system efficiency when compared to a constant 4.6V output voltage.

At a later time instant  $t_3$  when the PRECHG signal goes high, the amplifier  $G_{M2}$  is disabled and gives the control back to the amplifier  $G_{M1}$ . The amplifier  $G_{M1}$  regulates the output LED bus voltage towards the FB programmed maximum value 4.6V to guarantee shorter minimum LED on-time for the next grayscale PWM dimming

cycle. Without the precharging phase, the output LED bus voltage will stay at 3.8V before the next grayscale PWM dimming cycle, when all the 3 LED channels will be turned on again. At that time the 3.8V LED bus voltage is too low to keep all the LED channels in regulation, and the minimum LED on-time is greatly increased to accommodate the slow transient response of the switching buck converter charging the output capacitor from 3.8V to 4.6V. This adaptive-tracking-plus-precharging LED bus voltage technique simultaneously lowers the power dissipation in the LT3745-1 and maintains a shorter minimum LED on-time.

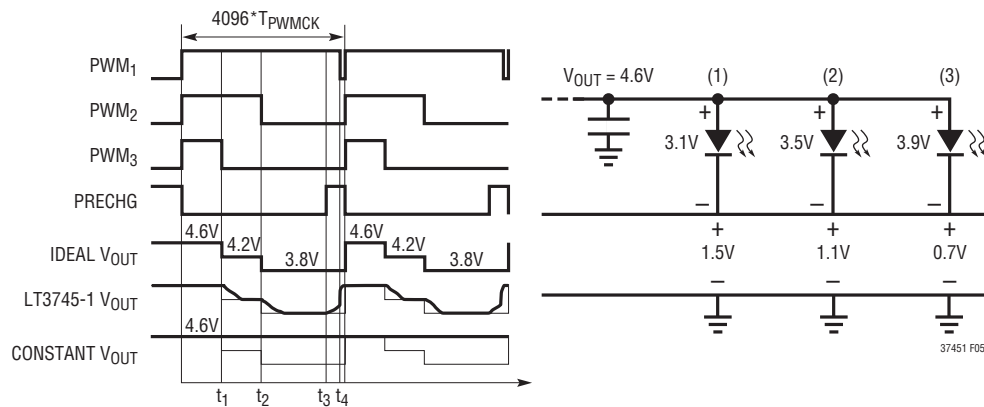

Figure 5. Adaptive-Tracking-Plus-Precharging LED Bus Voltage Technique

## APPLICATIONS INFORMATION

Globally, the LT3745-1 converts a higher input voltage to a single lower LED bus voltage ( $V_{OUT}$ ) supplying 16 parallel LED strings with the adaptive-tracking-plus-precharging technique. Locally, the part regulates and modulates the current of each string to an independent dot correction and grayscale PWM dimming setting sent by LVDS logic serial data interface. This Application Information section serves as a guideline of selecting external components (refer to the Block Diagram) and avoiding common pitfalls for the typical application.

### Programming Maximum $V_{OUT}$

The adaptive-tracking-plus-precharging technique regulates  $V_{OUT}$  to its maximum value during the start-up and precharging phases, and adaptively lowers the voltage to keep the minimum *active* LED pin voltage around 0.7V during the tracking phase. Therefore, the maximum  $V_{OUT}$  should be programmed high enough to keep all the LED pin voltages higher than 0.8V to maintain LED current regulation across temperature, current, and manufacturing variation. As a starting point, the maximum LED bus voltage,  $V_{OUT(MAX)}$ , can be calculated as:

$$V_{OUT(MAX)} = 0.8V + n \cdot V_{F(MAX)}$$

where  $n$  is the number of LED per string and  $V_{F(MAX)}$  is the maximum LED forward voltage rated at the highest operating current and the lowest operating temperature.

The  $V_{OUT(MAX)}$  is programmed with a resistor divider between the output and the FB pin. The resistor values are calculated as:

$$R_{FB2} = R_{FB1} \left( \frac{V_{OUT(MAX)}}{1.210V} - 1 \right)$$

Tolerance of the feedback resistors will add additional errors to the output voltage, so 1% resistor values should be used. The FB pin output bias current is typically 120nA, so use of extremely high value feedback resistors could also cause bias current errors. A typical value for  $R_{FB1}$  is 10k.

### $V_{IN}$ Power Input Supply Range

The power input supply for the LT3745-1 can range from 6V to 55V, covering a wide variety of industrial power supplies. Another restriction on the minimum input voltage  $V_{IN(MIN)}$  is the 2.1V minimum dropout voltage between the  $V_{IN}$  and ISN pins, and thus the  $V_{IN(MIN)}$  is calculated as:

$$V_{IN(MIN)} = V_{OUT(MAX)} + 2.1V$$

### Choosing Switching Frequency

Selection of the switching frequency is a trade-off between efficiency and component size. Low frequency operation improves efficiency by reducing MOSFET switching losses and gate charge losses. However, lower frequency operation requires larger inductor and capacitor values.

Another restriction on the switching frequency comes from the input and output voltage range caused by the minimum switch on and switch off-time. The highest switching frequency  $f_{SW(MAX)}$  for a given application can be calculated as:

$$f_{SW(MAX)} = \text{MIN} \left( \frac{D_{MIN}}{t_{ON(MIN)}}, \frac{1-D_{MAX}}{t_{OFF(MIN)}} \right)$$

where the minimum duty cycle  $D_{MIN}$  and the maximum duty cycle  $D_{MAX}$  are determined by:

$$D_{MIN} = \frac{V_{OUT(MIN)} + V_D}{V_{IN(MAX)} + V_D} \quad \text{and} \quad D_{MAX} = \frac{V_{OUT(MAX)} + V_D}{V_{IN(MIN)} + V_D}$$

$t_{ON(MIN)}$  is the minimum switch on-time (~200ns),  $t_{OFF(MIN)}$  is the minimum switch off-time (~120ns),  $V_{OUT(MIN)}$  is the minimum adaptive output voltage,  $V_{IN(MAX)}$  is the maximum input voltage, and  $V_D$  is the catch diode forward voltage (~0.5V). The calculation of  $f_{SW(MAX)}$  simplifies to:

$$f_{SW(MAX)} = \text{MIN} \left( 5 \cdot \frac{V_{OUT(MIN)} + V_D}{V_{IN(MAX)} + V_D}, 8.33 \cdot \frac{V_{IN(MIN)} - V_{OUT(MAX)}}{V_{IN(MIN)} + V_D} \right) \text{MHz}$$

## APPLICATIONS INFORMATION

Obviously, lower frequency operation accommodates both extremely high and low  $V_{OUT}$  to  $V_{IN}$  ratios.

Besides these common considerations, the specific application also plays an important role in switching frequency choice. In a noise-sensitive system, the switching frequency is usually chosen to keep the switching noise out of a sensitive frequency band.

### Switching Frequency Setting and Synchronization

The LT3745-1 uses a constant switching frequency that can be programmed from 200kHz to 1MHz with a resistor from the  $R_T$  pin to ground. Table 2 shows  $R_T$  values for common switching frequencies.

**Table 2. Switching Frequency  $f_{SW}$  vs  $R_T$  Value**

| $f_{SW}$ (kHz) | $R_T^*$ (k $\Omega$ ) |
|----------------|-----------------------|
| 200            | 280                   |
| 300            | 182                   |
| 400            | 133                   |
| 500            | 105                   |
| 600            | 84.5                  |
| 700            | 71.5                  |
| 800            | 60.4                  |
| 900            | 53.6                  |
| 1000           | 46.4                  |

\* Recommend 1% Standard Values

Synchronizing the LT3745-1 oscillator to an external frequency can be achieved using the SYNC pin. The square wave amplitude, compatible to TTL/CMOS logic, should have valleys that are below 0.6V and peaks that are above 2.4V. The synchronization frequency also ranges from 200kHz to 1MHz, in which the  $R_T$  resistor should be chosen to set the internal switching frequency around 20% below the synchronization frequency. In the case of 200kHz synchronization frequency,  $R_T = 348k$  is recommended. It is also important to note that when the synchronization frequency is much higher than the  $R_T$  programmed internal frequency, the internal slope compensation will be significantly reduced, which may trigger sub-harmonic oscillation at duty cycles greater than 50%.

### Inductor Current Sense Resistor $R_S$ and Current Limit

The current sense resistor,  $R_S$ , monitors the inductor current between the ISP and ISN pins, which are the inputs to the internal current sense amplifier. The common mode input voltage of the current sense amplifier ranges from 0V to ( $V_{IN} - 2.1V$ ) or 36V absolute maximum value, whichever is lower. The current sense amplifier not only provides current information to form the current mode control, but also a 44mV threshold. The 44mV threshold across the  $R_S$  resistor imposes an accurate current limit to protect both P-channel MOSFET M1 and catch diode D1, and also to prevent inductor current saturation. Good Kelvin sensing is required for accurate current limit. The  $R_S$  resistor value can be determined by:

$$I_{OUT(MAX)} = I_{L(MAX)} - \frac{\Delta I_L}{2}$$

where the maximum inductor current  $I_{L(MAX)}$  is set by:

$$I_{L(MAX)} = \frac{44mV}{R_S}$$

$I_{OUT(MAX)}$  is the maximum output load current, and  $\Delta I_L$  is the inductor peak-to-peak ripple current. Allowing adequate margin for ripple current and external component tolerances,  $R_S$  can be estimated as:

$$R_S = \frac{35mV}{I_{OUT(MAX)}}$$

### Inductor Selection

The critical parameters for selection of an inductor are inductance value, DC or RMS current, saturation current, and DCR resistance. For a given input and output voltage, the inductor value and switching frequency will determine the peak-to-peak ripple current,  $\Delta I_L$ . The  $\Delta I_L$  value usually ranges from 20% to 50% of the maximum output load current,  $I_{OUT(MAX)}$ . Lower values of  $\Delta I_L$  require larger and more costly inductors; higher values of  $\Delta I_L$  increase the peak currents and the inductor core loss. An inductor

## APPLICATIONS INFORMATION

current ripple of 30% to 40% offers a good compromise between inductor performance and inductor size and cost. However, for high duty cycle applications, a  $\Delta I_L$  value of ~20% should be used to prevent sub-harmonic oscillation due to insufficient slope compensation.

The largest inductor ripple current occurs at the highest  $V_{IN}$ . To guarantee that the ripple current stays below the specified maximum, the inductor value should be chosen according to the following equation:

$$L \geq \frac{V_{OUT} + V_D}{V_{IN(MAX)} + V_D} \cdot \frac{V_{IN(MAX)} - V_{OUT}}{f_{SW} \cdot \Delta I_L}$$

The inductor DC or RMS current rating must be greater than the maximum output load current  $I_{OUT(MAX)}$  and its saturation current should be higher than the maximum inductor current  $I_{L(MAX)}$ . To achieve high efficiency, the DCR resistance should be less than  $0.1\Omega$ , and the core material should be intended for high frequency applications.

### Power MOSFET Selection

Important parameters for the external P-channel MOSFET M1 include drain-to-source breakdown voltage ( $V_{(BR)DSS}$ ), maximum continuous drain current ( $I_{D(MAX)}$ ), maximum gate-to-source voltage ( $V_{GS(MAX)}$ ), total gate charge ( $Q_G$ ), drain-to-source on resistance ( $R_{DS(ON)}$ ), reverse transfer capacitance ( $C_{RSS}$ ). The MOSFET  $V_{(BR)DSS}$  specification should exceed the maximum voltage across the source to the drain of the MOSFET, which is  $V_{IN(MAX)}$  plus  $V_D$ . The  $I_{D(MAX)}$  should exceed the peak inductor current,  $I_{L(MAX)}$ . Since the gate driver circuit is supplied by the internal 6.8V  $V_{IN}$  referenced regulator, the  $V_{GS(MAX)}$  rating should be at least 10V.

Each switching cycle the MOSFET is switched off and on, a packet of gate charge  $Q_G$  is transferred from the  $V_{IN}$  pin to the GATE pin, and then from the GATE pin to the CAP pin. The resulting  $dQ_G/dt$  is a current that must be supplied to the  $C_{CAP}$  capacitor by the internal regulator. The maximum

22mA current capability of the internal regulator limits the maximum  $Q_{G(MAX)}$  it can deliver to:

$$Q_{G(MAX)} = \frac{22mA}{f_{SW}}$$

Therefore, the  $Q_G$  at  $V_{GS} = 6.8V$  from the MOSFET data sheet should be less than  $Q_{G(MAX)}$ .

For maximum efficiency, both  $R_{DS(ON)}$  and  $C_{RSS}$  should be minimized. Lower  $R_{DS(ON)}$  means less conduction loss while lower  $C_{RSS}$  reduces transition loss. Unfortunately,  $R_{DS(ON)}$  is inversely related to  $C_{RSS}$ . Thus balancing the conduction loss with the transition loss is a good criterion in selecting a MOSFET. For applications with higher  $V_{IN}$  voltages ( $\geq 24V$ ) a lower  $C_{RSS}$  is more important than a low  $R_{DS(ON)}$ .

### Catch Diode Selection

The catch diode D1 carries load current during the switch off-time. Important parameters for the catch diode includes peak repetitive reverse voltage ( $V_{RRM}$ ), forward voltage ( $V_F$ ), and maximum average forward current ( $I_{F(AV)}$ ). The diode  $V_{RRM}$  specification should exceed the maximum reverse voltage across it, i.e.,  $V_{IN(MAX)}$ . A fast switching Schottky diode with lower  $V_F$  should be used to yield lower power loss and higher efficiency.

In continuous conduction mode, the average current conducted by the catch diode is calculated as:

$$I_{D(AVG)} = I_{OUT} \cdot (1 - D)$$

The worst-case condition for the diode is when  $V_{OUT}$  is shorted to ground with maximum  $V_{IN}$  and maximum  $I_{OUT}$  at present. In this case, the diode must safely conduct the maximum load current almost 100% of the time. To improve efficiency and to provide adequate margin for short-circuit operation, a Schottky diode rated to at least the maximum output current is recommended.



## APPLICATIONS INFORMATION

### $C_{IN}$ , $C_{VCC}$ , and $C_{CAP}$ Capacitor Selection

A local input bypass capacitor  $C_{IN}$  is required for buck converters because the input current is pulsed with fast rise and fall times. The input capacitor selection criteria are based on the voltage rating, bulk capacitance, and RMS current capability. The capacitor voltage rating must be greater than  $V_{IN(MAX)}$ . The bulk capacitance determines the input supply ripple voltage and the RMS current capability is used to keep from overheating the capacitor.

The bulk capacitance is calculated based on maximum input ripple,  $\Delta V_{IN}$ :

$$C_{IN} = \frac{D_{MAX} \cdot I_{OUT(MAX)}}{\Delta V_{IN} \cdot f_{SW}}$$

$\Delta V_{IN}$  is typically chosen at a level acceptable to the user. 100mV is a good starting point. For ceramic capacitors, only X5R or X7R type should be used because they retain their capacitance over wider voltage and temperature ranges than other types such as Y5V or Z5U. Aluminum electrolytic capacitors are a good choice for high voltage, bulk capacitance due to their high capacitance per unit area.

The capacitor RMS current is:

$$I_{CIN(RMS)} = I_{OUT} \cdot \sqrt{\frac{V_{OUT} \cdot (V_{IN} - V_{OUT})}{V_{IN}^2}}$$

If applicable, calculate at the worst-case condition,  $V_{IN} = 2 \cdot V_{OUT}$ . The capacitor RMS current rating specified by the manufacturer should exceed the calculated  $I_{CIN(RMS)}$ . Due to their low ESR, ceramic capacitors are a good choice for high voltage, high RMS current handling. Note that the ripple current ratings from aluminum electrolytic capacitor manufacturers are based on 2000 hours of life. This makes it advisable to further derate the capacitor or to choose a capacitor rated at a higher temperature than required.

For a larger high voltage capacitor value, the combination of aluminum electrolytic capacitors and ceramic capacitors is an economical approach. Multiple capacitors may also

be paralleled to meet size or height requirements in the design. Locate the capacitor very close to the MOSFET switch and the catch diode, and use short, wide PCB traces to minimize parasitic inductance.

The general discussion above also applies to the capacitor  $C_{VCC}$  at the  $V_{CC}$  pin and the capacitor  $C_{CAP}$  between the  $V_{IN}$  and  $CAP$  pins. Typically, a 10 $\mu$ F 10V-rated ceramic capacitor for  $C_{VCC}$  and a 0.47 $\mu$ F 16V-rated ceramic capacitor for  $C_{CAP}$  should be sufficient.

### $C_{OUT}$ Capacitor Selection

The output capacitor has two essential functions. Along with the inductor, it filters the square wave generated by the LT3745-1 to produce the DC output containing a controlled voltage ripple. It also stores energy to satisfy load transients and to stabilize the dual-loop operation. Thus the selection criteria for  $C_{OUT}$  are based on the voltage rating, the equivalent series resistance ESR, and the bulk capacitance. As always, choose the  $C_{OUT}$  with a voltage rating greater than  $V_{OUT(MAX)}$ .

The LT3745-1 utilizes the output as the dominant pole to stabilize the dual loop operation, so the  $C_{OUT}$  value determines the unity gain frequency  $f_{UGF}$ , which is set around 1/10 of the switching frequency. To stabilize the FB loop during the start-up and precharging phases and the LED loop during the tracking phase, a low ESR capacitor (tens of m $\Omega$ ) should be used and its minimum  $C_{OUT}$  is calculated as:

$$C_{OUT} = \text{MAX} \left( \frac{0.25}{R_S \cdot f_{UGF}}, \frac{1.5}{V_{OUT(MAX)} \cdot R_S \cdot f_{UGF}} \right)$$

The adaptive-tracking-plus-precharging technique moves the  $V_{OUT}$  with the grayscale PWM dimming frequency to improve system efficiency, choosing a ceramic capacitor as the  $C_{OUT}$  inevitably generates acoustic noise due to the piezo effect of the ceramic material. In an acoustic noise sensitive application, low ESR tantalum or aluminum capacitors are preferred. When choosing a capacitor,

## APPLICATIONS INFORMATION

look carefully through the data sheet to find out what the actual capacitance is under operating conditions (applied voltage and temperature). A physically larger capacitor, or one with a higher voltage rating, may be required.

### Undervoltage Lockout (UVLO) and Shutdown

LT3745-1 has three UVLO thresholds with hysteresis for the EN/UVLO,  $V_{CC}$ , and CAP pins. The part will remain in UVLO mode not switching until all the EN/UVLO,  $V_{CC}$ , and  $(V_{IN} - V_{CAP})$  voltages pass their respective typical thresholds (1.30V, 2.86V, and 4.9V). As shown in Figure 6, the EN/UVLO pin can be controlled in two different ways. The EN/UVLO pin can accept a digital input signal to enable or disable the chip. Tie to 0.35V or lower to shut down the chip or tie to 1.34V or higher for normal operation. This pin can also be connected to a resistor divider between  $V_{IN}$  and ground to program a power input  $V_{IN}$  UVLO threshold. After  $R_{UV1}$  is selected,  $R_{UV2}$  can be calculated by:

$$R_{UV2} = R_{UV1} \cdot \left( \frac{V_{IN(ON)}}{1.3V} - 1 \right)$$

where  $V_{IN(ON)}$  is the power input voltage above which the part goes into normal operation. It is important to check the EN/UVLO pin voltage not to exceed its 4V absolute maximum rating:

$$V_{IN(MAX)} \cdot \frac{R_{UV1}}{R_{UV1} + R_{UV2}} < 4V$$

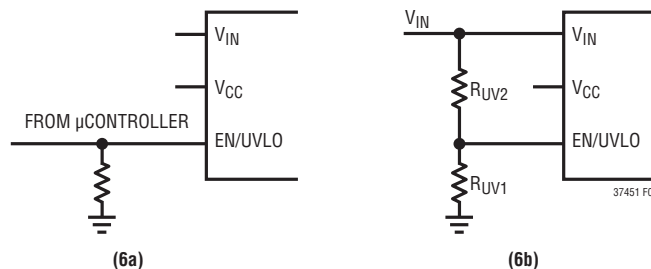

Figure 6. Methods of Controlling the EN/UVLO Pin

### Soft-Start

During soft-start, the SS pin voltage smoothly ramps up inductor current and output voltage. The effective voltage range of SS pin is from 0V to 1V. Therefore, the typical soft-start period is:

$$t_{SS} = \frac{C_{SS} \cdot 1V}{12\mu A}$$

where  $C_{SS}$  is the capacitor connected at SS pin and  $12\mu A$  is the soft-start charge current. Whenever a UVLO or thermal shutdown occurs, the SS pin will be discharged and the part will stop switching until the UVLO event has disappeared and the SS pin has reached its reset threshold, 0.35V. The part then initiates a new soft-start cycle.

### Setting Nominal LED Current

The nominal LED current is defined as the average LED current across 16-channel when all the individual dot correction registers are set to 0x20. The nominal LED current is programmed by a single resistor,  $R_{ISET}$ , between the  $I_{SET}$  pin and ground. The voltage at the  $I_{SET}$  pin,  $V_{ISET}$ , is trimmed to an accurate 1.205V, generating a current inversely proportional to  $R_{ISET}$ . The nominal LED current,  $I_{LED(NOM)}$ , can be calculated as:

$$I_{LED(NOM)} = \frac{V_{ISET}}{R_{ISET}} \cdot 2500$$

## APPLICATIONS INFORMATION

$I_{LED(NOM)}$  must be set between 10mA and 50mA. Typical  $R_{ISET}$  resistor values for various nominal LED currents are listed in Table 3.

**Table 3. Nominal LED Current  $I_{LED(NOM)}$  vs.  $R_{ISET}$  Value**

| $I_{LED(NOM)}$ (mA) | $R_{ISET}^*$ (k $\Omega$ ) |
|---------------------|----------------------------|
| 10                  | 301                        |
| 20                  | 150                        |
| 30                  | 100                        |
| 40                  | 75                         |
| 50                  | 60.4                       |

\* Recommend 1% Standard Values

### Setting Dot Correction

The LT3745-1 can adjust the LED current for each channel independently. This fine current adjustment, also called dot correction, is mainly used to calibrate the brightness deviation between LED channels. The 6-bit (64 steps) dot correction setting adjusts each LED current from 0.5X to 1.5X of the nominal LED current according to:

$$I_{LEDn} = I_{LED(NOM)} \cdot \left( \frac{DC_n + 32}{64} \right)$$

where  $I_{LEDn}$  is the nth LED current and  $DC_n$  is the nth programmed dot correction setting ( $DC_n = 0$  to 63). The fine current step over the nominal LED current gives an excellent resolution:

$$\frac{\Delta I_{LED}}{I_{LED(NOM)}} = \frac{1}{64} \approx 1.56\%$$

which enhances the relative LED current match accuracy if used as calibration.

### Setting Grayscale

Although adjusting the LED current changes its luminous intensity, or brightness, it will also affect the color matching between LED channels by shifting the chromaticity coordinate. The best way to adjust the brightness is to

control the amount of LED on-/off-time by pulse width modulation (PWM).

The LT3745-1 can adjust the brightness for each channel independently. The 12-bit grayscale PWM dimming results in 4096 linear brightness steps from 0% to 99.98%. The brightness level  $GS_n\%$  for channel n can be calculated as:

$$GS_n\% = \frac{GS_n}{4096} \cdot 100\%$$

where  $GS_n$  is the nth programmed grayscale setting ( $GS_n = 0$  to 4095).

### Open/Short LED Fault

The LT3745-1 has individual LED fault diagnostic circuitry that detects both open and short LED faults for each channel. The open LED fault is defined as any LED string is open or disconnected from the circuit; and the short LED fault is defined as any LED string is shorted across itself. The open LED flag is set if the LED pin voltage is lower than 0.35V (typical) during on status with initial 500ns blanking. The short LED flag is set if the LED pin voltage is higher than 75% of the LED bus voltage  $V_{OUT}$  any time. If one LED channel is shorted across itself, the channel will be turned off to eliminate unnecessary power dissipation. The function can also be used to disable LED channels by connecting their LED pins to the output directly. Both the open and short LED flags are combined to set the LED fault bits (S0 to S15) in the status frame to 1.

### Thermal Protection

The LT3745-1 has two overtemperature thresholds: one is the fixed internal thermal shutdown and the other one is programmed by a resistor,  $R_{TSET}$ , between the  $T_{SET}$  pin and ground. When the junction temperature exceeds 165°C, the part will enter thermal shutdown mode, shut down serial data interface, turn off LED channels, and stop switching. After the junction temperature drops below 155°C, the part will initiate a new soft-start.



## APPLICATIONS INFORMATION

When the  $R_{TSET}$  is placed at the  $T_{SET}$  pin, a current equal to the current flowing through the  $R_{ISET}$  passes the  $R_{TSET}$ , generating a voltage  $V_{TSET}$  at the  $T_{SET}$  pin, which is calculated as:

$$V_{TSET} = 1.205V \cdot \frac{R_{TSET}}{R_{ISET}}$$

Then the  $V_{TSET}$  is compared to an internal proportional-to-absolute-temperature voltage  $V_{PTAT}$ ,

$$V_{PTAT} = 1.72mV \cdot (T_J + 273.15)$$

where  $T_J$  is the LT3745-1 junction temperature in °C. When  $V_{PTAT}$  is higher than  $V_{TSET}$ , an overtemperature flag  $OT = 1$  is set. Once the  $R_{TSET}$  programmed temperature is exceeded, the part will also gradually derate the nominal LED current  $I_{LED(NOM)}$  to limit the total power dissipation without interrupting its normal operation.

### Cascading Devices and Determining Serial Data Interface Clock

In a large LCD backlighting or LED display system, multiple LT3745-1 chips can be easily cascaded to drive all the LED strings. The minimum serial data interface clock frequency  $f_{SCKI}$  for a large display system can be calculated as:

$$f_{SCKI} = N_{LT3745-1} \cdot 194 \cdot f_{REFRESH}$$

where  $N_{LT3745-1}$  is the number of LT3745-1 chips and  $f_{REFRESH}$  is the refresh rate of the whole system.

### Calculating Power Dissipation

The total power dissipation inside the chip can be calculated as:

$$P_{TOTAL} = V_{IN} \cdot (I_{VIN} + f_{SW} \cdot Q_G) + V_{CC} \cdot I_{VCC} + \sum_{n=0}^{15} GS_n\% \cdot I_{LEDn} \cdot V_{LEDn}$$

where  $I_{VIN}$  is the power input  $V_{IN}$  quiescent current,  $I_{VCC}$  is the  $V_{CC}$  supply current, and  $V_{LEDn}$  is the LED pin voltage for channel  $n$ .

From the total power dissipation  $P_{TOTAL}$ , the junction temperature  $T_J$  can be calculated as:

$$T_J = T_A + P_{TOTAL} \cdot \theta_{JA}$$

Keep  $T_J$  below the maximum operating junction temperature 125°C.

## TYPICAL APPLICATION

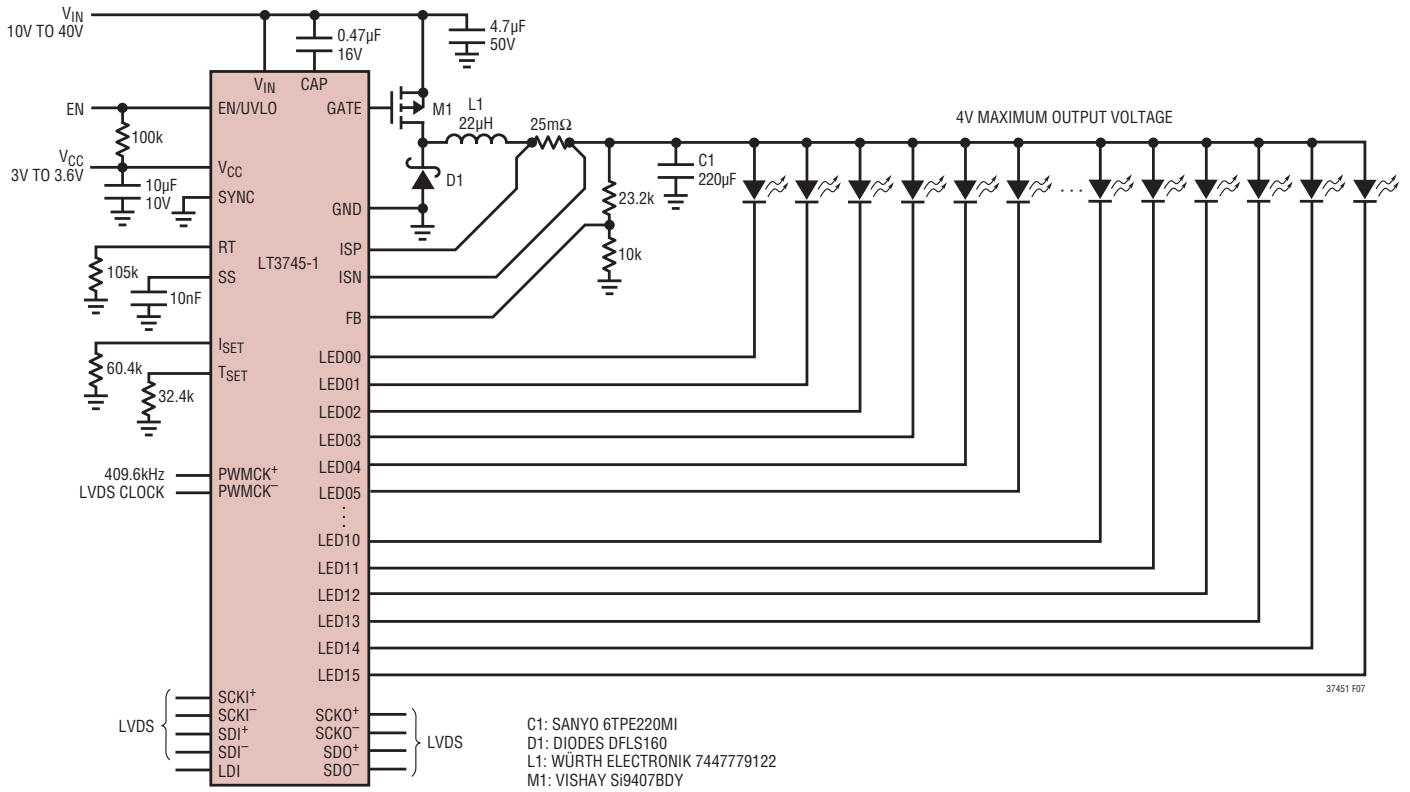
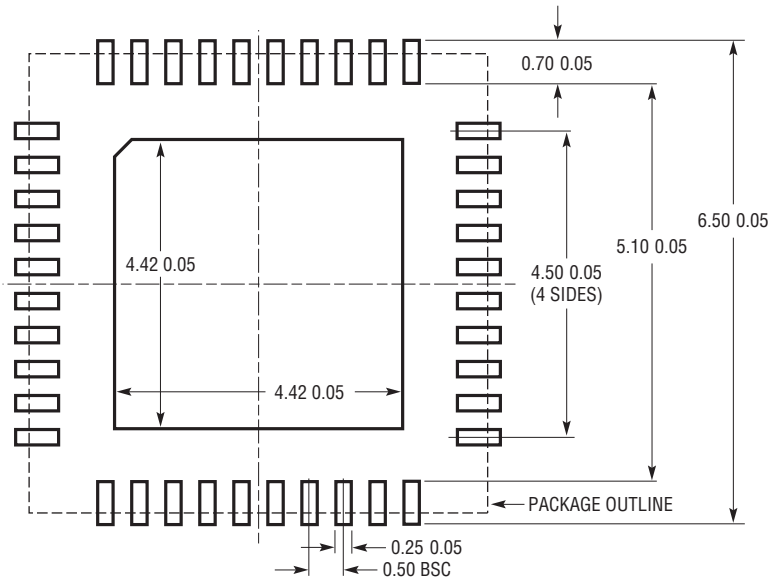

Figure 7. 16-Channel LED Driver, 500kHz Buck, 1 LED 25mA to 75mA per Channel, 100Hz 12-Bit Dimming

# PACKAGE DESCRIPTION

Please refer to <http://www.linear.com/designtools/packaging/> for the most recent package drawings.

**UJ Package**  
**40-Lead Plastic QFN (6mm × 6mm)**  
 (Reference LTC DWG # 05-08-1728 Rev 0)



RECOMMENDED SOLDER PAD PITCH AND DIMENSIONS  
 APPLY SOLDER MASK TO AREAS THAT ARE NOT SOLDERED

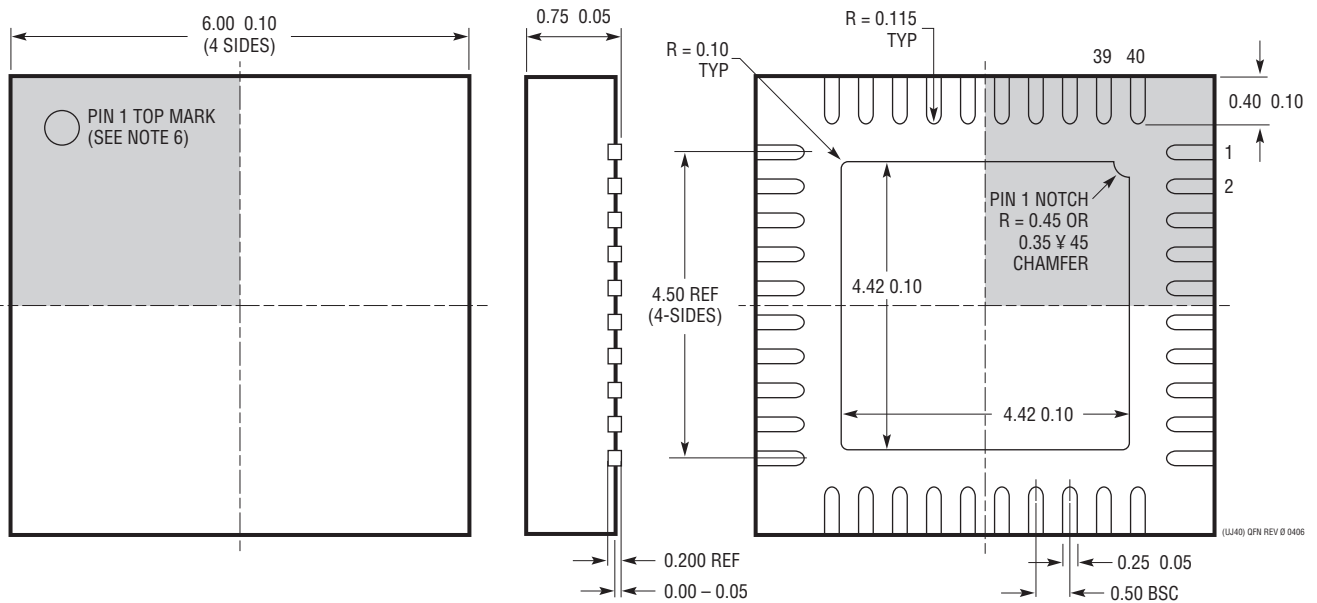

- NOTE:
1. DRAWING IS A JEDEC PACKAGE OUTLINE VARIATION OF (WJJD-2)
  2. DRAWING NOT TO SCALE
  3. ALL DIMENSIONS ARE IN MILLIMETERS
  4. DIMENSIONS OF EXPOSED PAD ON BOTTOM OF PACKAGE DO NOT INCLUDE MOLD FLASH. MOLD FLASH, IF PRESENT, SHALL NOT EXCEED 0.20mm ON ANY SIDE, IF PRESENT
  5. EXPOSED PAD SHALL BE SOLDER PLATED
  6. SHADED AREA IS ONLY A REFERENCE FOR PIN 1 LOCATION ON THE TOP AND BOTTOM OF PACKAGE

BOTTOM VIEW—EXPOSED PAD

## TYPICAL APPLICATION

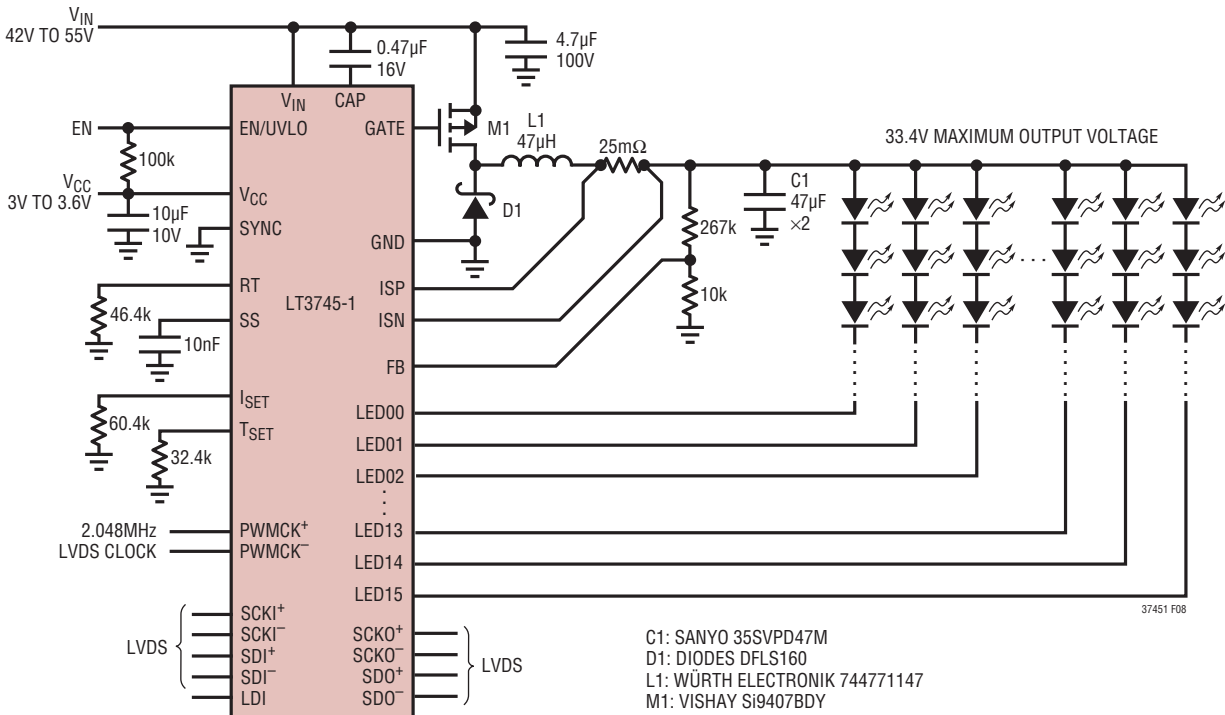

Figure 8. 16-Channel LED Driver, 1MHz Buck, 10 LEDs, 25mA to 75mA per Channel, 500Hz 12-Bit Dimming

## RELATED PARTS

| PART NUMBER | DESCRIPTION  | COMMENTS   |
|-------------|--|--|
| LT3745      | 16-Channel 50mA LED Driver with Buck Controller  | $V_{IN}$ : 6V to 55V, $V_{OUT(MAX)}$ = 36V, 6-Bit Dot Correction Current Adjustment, 12-Bit Grayscale Dimming, 6mm × 6mm QFN Package |
| LT3746      | 32-Channel 20mA LED Driver with Buck Controller  | $V_{IN}$ : 6V to 55V, $V_{OUT(MAX)}$ = 13V, 6-Bit Dot Correction Current Adjustment, 12-Bit Grayscale Dimming, 5mm × 9mm QFN Package |
| LT3476      | Quad Output 1.5A, 2MHz High Current LED Driver with 1,000:1 Dimming                                      | $V_{IN}$ : 2.8V to 16V, $V_{OUT(MAX)}$ = 36V, True Color PWM™ Dimming = 1000:1, $I_{SD}$ < 10µA, 5mm × 7mm QFN-10 Package            |
| LT3486      | Dual 1.3A, 2MHz High Current LED Driver  | $V_{IN}$ : 2.5V to 24V, $V_{OUT(MAX)}$ = 36V, True Color PWM Dimming = 1000:1, $I_{SD}$ < 1µA, 5mm × 3mm DFN-16 TSSOP-16E Package    |
| LT3496      | Triple Output 750mA, 2.1 MHz High Current LED Driver with 3,000:1 Dimming                                | $V_{IN}$ : 3V to 30V, $V_{OUT(MAX)}$ = 60V, True Color PWM Dimming = 3000:1, $I_{SD}$ < 1µA, 4mm × 5mm QFN-28 Package                |
| LT3595      | 45V, 2.5MHz 16-Channel Full Featured LED Driver  | $V_{IN}$ : 4.5V to 45V, $V_{OUT(MAX)}$ = 45V, True Color PWM Dimming = 5000:1, $I_{SD}$ < 1µA, 5mm × 9mm QFN-56 Package              |
| LT3598      | 44V, 1.5A, 2.5MHz Boost 6-Channel 30mA LED Driver  | $V_{IN}$ : 3V to 40V, $V_{OUT(MAX)}$ = 44V, True Color PWM Dimming = 1000:1, $I_{SD}$ < 1µA, 4mm × 4mm QFN-24 Package                |
| LT3599      | 44V, 2A, 2.5MHz Boost 4-Channel 120mA LED Driver   | $V_{IN}$ : 3V to 40V, $V_{OUT(MAX)}$ = 44V, True Color PWM Dimming = 1000:1, $I_{SD}$ < 1µA, 4mm × 4mm QFN-24 Package                |
| LT3754      | 60V, 1MHz Boost 16-Channel 50mA LED Driver with True Color 3,000:1 PWM Dimming and 2.8% Current Matching | $V_{IN}$ : 4.5V to 40V, $V_{OUT(MAX)}$ = 60V, True Color PWM Dimming = 3000:1, $I_{SD}$ < 1µA, 5mm × 5mm QFN-32 Package              |
| LT3760      | 60V, 1MHz Boost 8-Channel 100mA LED Driver with True Color 3,000:1 PWM Dimming and 2.8% Current Matching | $V_{IN}$ : 4.5V to 40V, $V_{OUT(MAX)}$ = 60V, True Color PWM Dimming = 3000:1, $I_{SD}$ < 1µA, TSSOP-28E Package                     |