

FEATURES

- * SELECTED TO SPECIFIC ON-LINE INTENSITY AND RADIANT INTENSITY RANGES
- * LOW COST MINIATURE PLASTIC END LOOKING PACKAGE
- * MECHANICALLY AND SPECTRALLY MATCHED TO THE LTR-4206 SERIES OF PHOTOTRANSISTOR
- * CLEAR TRANSPARENT COLOR PACKAGE

PACKAGE DIMENSIONS

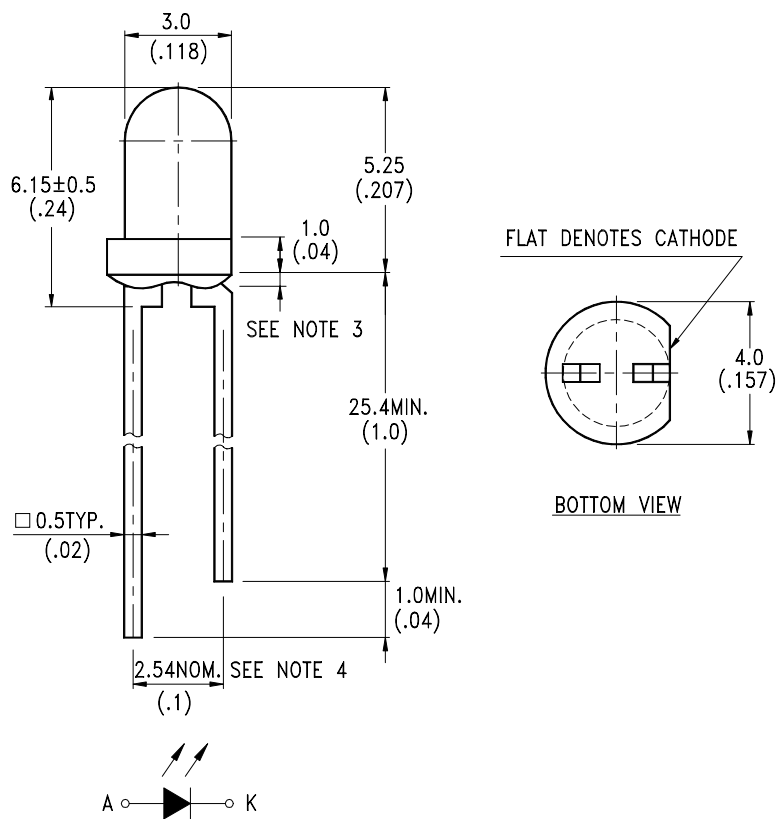

NOTES:

1. All dimensions are in millimeters (inches).
2. Tolerance is $\pm 0.25\text{mm}(.010\text{'})$ unless otherwise noted.
3. Protruded resin under flange is 1.0mm(.039'') max.
4. Lead spacing is measured where the leads emerge from the package.
5. Specifications are subject to change without notice.



LITE-ON ELECTRONICS, INC.

Property of Lite-On Only

ABSOLUTE MAXIMUM RATINGS AT TA=25°C

PARAMETER	MAXIMUM RATING	UNIT
Power Dissipation	90	mW
Peak Forward Current (300pps, 10 μs pulse)	1	A
Continuous Forward Current	60	mA
Reverse Voltage	5	V
Operating Temperature Range	-40°C to + 85°C	
Storage Temperature Range	-55°C to + 100°C	
Lead Soldering Temperature [1.6mm(.063") From Body]	260°C for 5 Seconds	

ELECTRICAL OPTICAL CHARACTERISTICS AT TA=25°C

PARAMETER	SYMBOL	MIN.	TYP.	MAX.	UNIT	TEST CONDITION	BIN NO.
Aperture Radiant Incidence	Ee	0.184		0.54	mW/cm ²	I _F = 20mA	BIN A
		0.36		0.78			BIN B
		0.52		1.02			BIN C
		0.68					BIN D
Radiant Intensity	I _E	1.383		4.06	mW/sr	I _F = 20mA	BIN A
		2.71		5.87			BIN B
		3.91		7.67			BIN C
		5.11					BIN D
Peak Emission Wavelength	λ _{Peak}		940		nm	I _F = 20mA	
Spectral Line Half-Width	Δλ		50		nm	I _F = 20mA	
Forward Voltage	V _F		1.2	1.6	V	I _F = 20mA	
Reverse Current	I _R			100	μA	V _R = 5V	
Viewing Angle (See FIG.6)	2θ _{1/2}		20		deg.		

TYPICAL ELECTRICAL / OPTICAL CHARACTERISTICS CURVES

(25°C Ambient Temperature Unless Otherwise Noted)

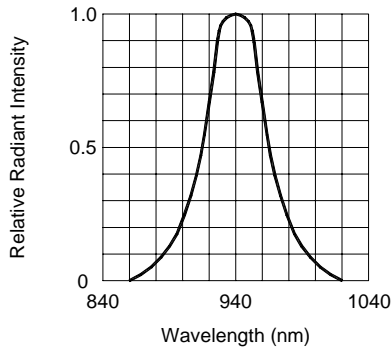

FIG.1 SPECTRAL DISTRIBUTION

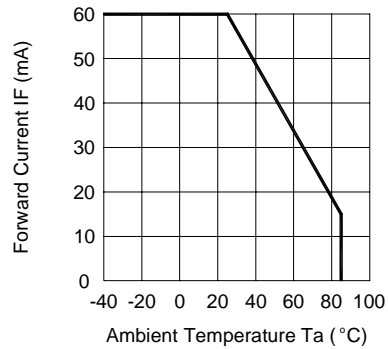

FIG.2 FORWARD CURRENT VS. AMBIENT TEMPERATURE

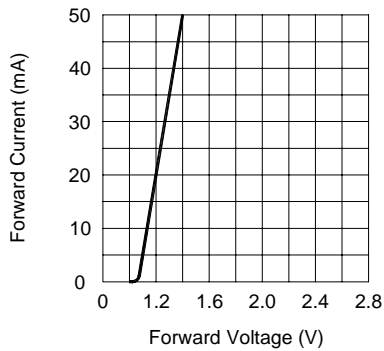

FIG.3 FORWARD CURRENT VS. FORWARD VOLTAGE

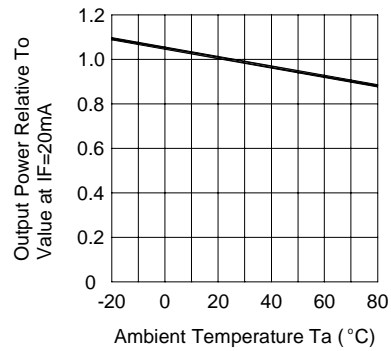

FIG.4 RELATIVE RADIANT INTENSITY VS. AMBIENT TEMPERATURE

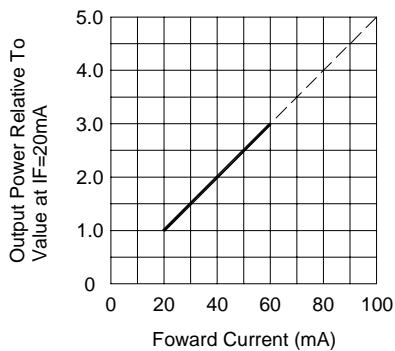

FIG.5 RELATIVE RADIANT INTENSITY VS. FORWARD CURRENT

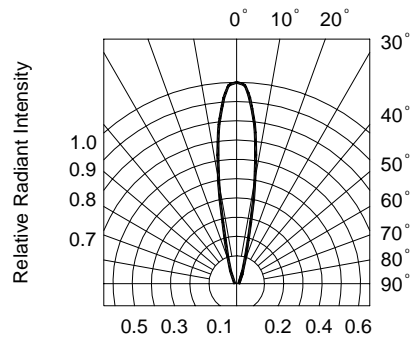

FIG.6 RADIATION DIAGRAM