



## M7100

### Pressure Transducer

#### SPECIFICATIONS

- Performance standard on and off highway engine and vehicle OEMs
- Rugged for heavy equipment and outdoor use
- Designed specifically for high volume applications
- Stainless steel wetted surfaces
- Medium to high pressures
- CE Approved
- UL Certified
- Gage

The M7100 pressure transducer from the Microfused line of MEAS sets a new price performance standard for demanding engine and vehicle, and industrial applications. This transducer is suitable for measurement of liquid or gas pressure, even for difficult media such as contaminated water, steam and corrosive fluids.

The transducer pressure cavity is machined from a solid piece of 17-4 PH stainless steel. The standard version includes a 1/4 NPT pipe thread allowing a leak-proof, all metal sealed system. There are no o-rings or organics exposed to the pressure media and the durability is excellent. This automotive grade pressure transducer with stainless steel hermetic pressure ports and integral electrical connector can boast up to 10,000psi (700Bar). The M7100 is UL certified and exceeds the latest industrial CE requirements including surge protection and is overvoltage protected in both positive and reverse polarity.

## FEATURES

- Hermetic Pressure Ports
- Integral Electrical Connector
- Survives High Vibration
- $\pm 0.25\%$  Accuracy
- Water Resistant 1M Immersion

## APPLICATIONS

- On and Off Highway Engines and Vehicles
- HVAC Refrigeration Controls
- Compressors
- Hydraulics
- Energy and Water Management

## STANDARD RANGES

Range (psi)	Range (Bar)	Gage
0 to 150	0 to 010	•
0 to 200	0 to 014	•
0 to 300	0 to 020	•
0 to 500	0 to 035	•
0 to 01K	0 to 070	•
0 to 1K5	0 to 100	•
0 to 03K	0 to 200	•
0 to 05K	0 to 350	•
0 to 7K5	0 to 500	•
0 to 10K	0 to 700	•

## PERFORMANCE SPECIFICATIONS

Ambient Temperature: 25°C (unless otherwise specified)

PARAMETERS	MIN	TYP	MAX	UNITS	NOTES
Load Resistance	10			KΩ	
Accuracy (combined linearity, hysteresis & repeatability)	-0.25		0.25	%Span	1
Total Error Band	-1.0		1.0	%Span	2
Compensated Temperature	-20		+85	°C	
Operating Temperature	-40		+125	°C	3
Storage Temperature	-50		+125	°C	
Insulation Resistance (500Vdc)	100			MΩ	4
Short Circuit Protected		Yes			
Output Noise @ 1kHz		10		mV	
Long Term Stability	-0.25		0.25	%Span/Year	
Frequency Response @ -3dB		1		KHz	

**Notes**

1. Best fit straight line.
2. TEB includes all accuracy errors, thermal errors, span and zero tolerances over the compensated temperature range.
3. Temperature range for product with standard cable is -20°C to +105°C.
4. Between sensor body to any pins of connector.

## ENVIRONMENTAL SPECIFICATIONS

Ambient Temperature: 25°C (unless otherwise specified)

PARAMETERS	MIN	TYP	MAX	UNITS	NOTES
Humidity (@40°C)			93	%RH	
Pressure Overload			2X	Rated	5
Pressure Burst			5X	Rated	6
Pressure Cycle	10M			Cycles	
Media, Pressure Port	Fluids compatible with 17-4PH Stainless Steel				
Mechanical Vibration	20g, 10 ~ 2000Hz MIL-STD-810C, Method 514.2, Curve L				
Mechanical Shock	Half-Sine, Peak: 50g, 11ms MIL-STD-202, Method 213B, Condition A				
Package Protection	IP67 (IEC60529)				

**Notes**

5. The maximum pressure that can be applied without changing the transducer's performance or accuracy.
6. The maximum pressure that can be applied to a transducer without rupture of either the sensing element or transducer.

**Agency Approvals**

RoHS: RoHS 2 (Directive 2011/65/EU)

UL 508 Certified: Industrial Control Equipment, CSA 22.2 No. 14-10

EMC Performance Criteria: Output Change < ±1.5% FSO

IEC61000-4-2 ESD: 8kV Contact / 15kV Air; Discharge Rate > 10s

IEC61000-4-3 EM Field: 100V/m, 1kHz 80% Modulation, 80 ~ 1000MHz

IEC61000-4-4 Electrical Fast Transient: Level 2, 1KV each line, Capacitance coupling

IEC61000-4-5 Surge: Level 2, 42Ω Impedance, Figure 11 (L-L 500V, L-E 1KV)

IEC61000-4-6 Conducted RF: Level 2, 3V/130dB, 150KHz ~ 80MHz, 2s Dwell, Clamp Injection

IEC61000-4-9 Pulse Magnetic Field: Level 3, 100A/m, 10 Second pulse interval

IEC55022 Emission: Class B, 30dB @ 30-230MHz, 37dB @ 230-1000MHz

## M7100

### Pressure Transducer

Pressure Port Options	Dim A	Tightening Torque (Nm)
2 = G1/4, BS5380, Male	.43 [11.0]	30~35
4 = 7-16-20 UNF, SAE J1926-2, Male, w/ O-Ring	.36 [9.1]	18~20
5 = 1/4-18 NPT Male	.56 [14.2]	2~3 T.F.F.T.
6 = 1/8-27 NPT Male	.38 [9.7]	2~3 T.F.F.T.
E = R1/4-19, Male	.56 [14.2]	2~3 T.F.F.T.
F = G1/4-19, BS5380, Female	.64 [16.3]	30~35
P = 7/16-20UNF Female w/ Integral Valve Depressor; 1/4 Flare Gasket SAE J513C, Copper	.64 [16.3]	15~16
Q = M10 x 1.0, ISO 6149-2, Male	.37 [9.5]	15~16
S = M12 x 1.5, ISO 6149-2, Male	.43 [11.0]	28~30
G = M14 x 1.5, ISO 6149-2, Male	.43 [11.0]	30~35
U = G1/4, DIN 3852-E, Male	.47 [12.0]	30~35

#### Notes: Installation

\*T.F.F.T.: Turns From Finger Tight

Transducers can be installed by either spanner or deep socket. Torque values provided are for reference: actual torque depends upon mating port material, surface finish, lubrication and sealing mechanism. Transducers calibration and/or zero may shift if part is over-torqued during installation. Check for a zero shift after installing.

Connector	Connector, Pin Plating		Connector, Mating
Packard Metri-Pack 150 Series	<i>powerandsignal.com</i>	0.003 – 0.005 mm Sn	Housing P/N: 12065287 Terminals P/N: 12103881
Sumitomo HV040 Series	<i>sumitomokenki.com</i>	0.003 mm Sn over 0.0005 – 0.001 mm Cu	Housing P/N: 6189-6907 Terminals P/N: 8100-3067/8
AMP Econoseal-J Mark II 070 Series	<i>te.com</i>	0.0004 mm Au over 0.0013 mm Ni	Housing P/N: 174357 Terminals P/N: 171630

#### Notes: Connector

Do not apply torque to the connector housing of transducer.

To ensure proper environmental sealing and electrical connection when using a mating connector, follow the manufacturer's installation guidelines.

# M7100

Pressure Transducer

## DIMENSIONS

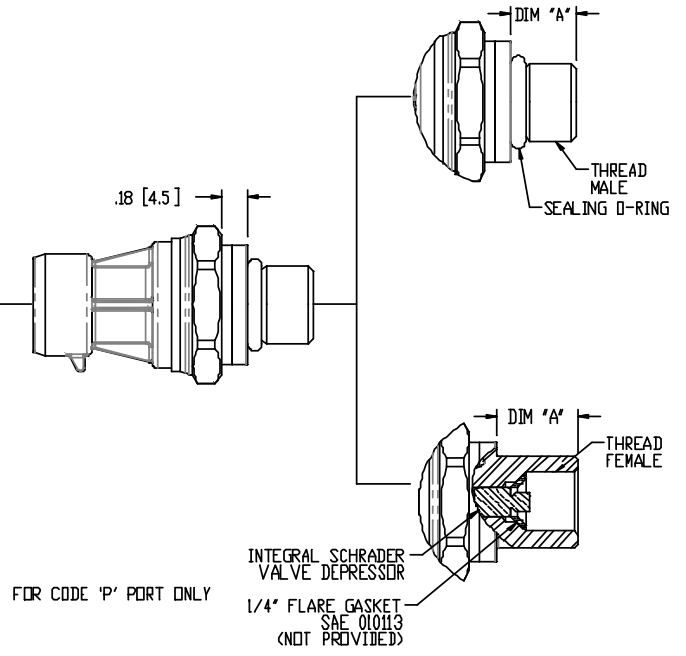
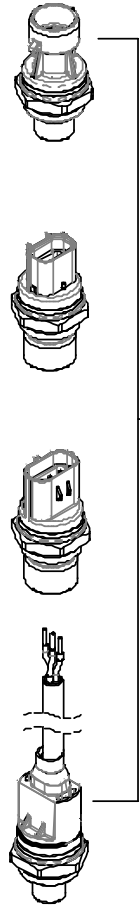
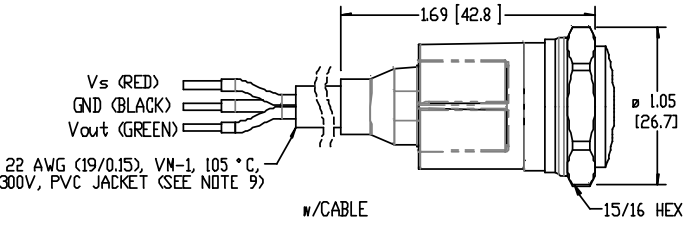
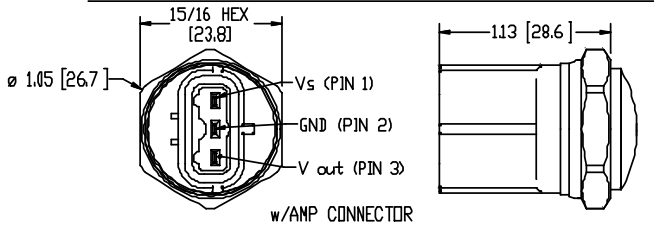
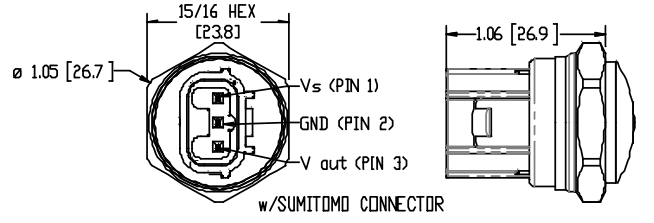
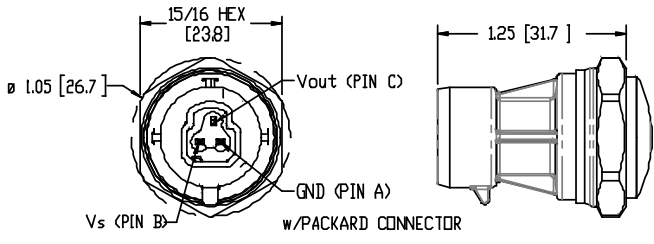

CHARTS

**Pressure Transfer Function**

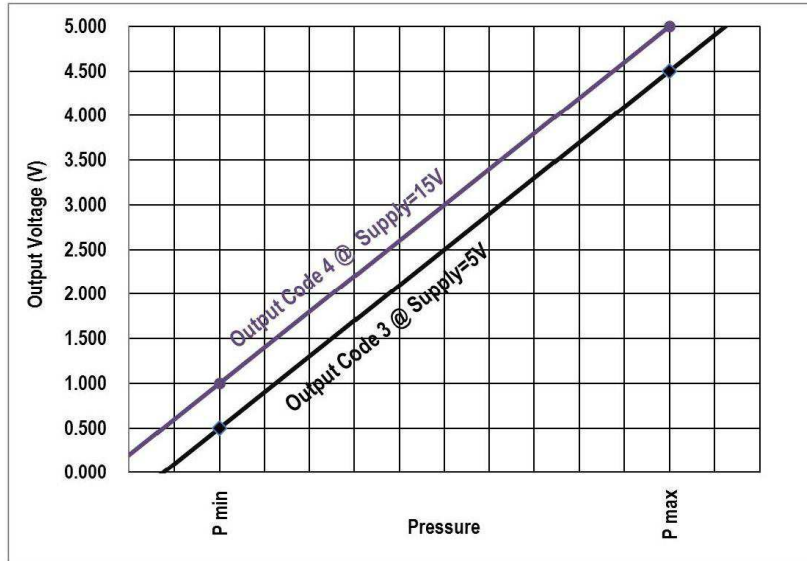

**Output Type vs. Supply**

Output Type (Code)	3	4
Supply Voltage	4.75 ~ 5.25V*	8 ~ 32V
Supply Current	4.0 ~ 10.0mA	
Output Voltage	0.5 ~ 4.5V*	1.0 ~ 5.0V
Reverse Voltage	16V	
Overvoltage Protection	16V	32V

\* Output ratiometric to supply voltage

