

# NCP59749

## 3.0 A, Dual-Rail Very Low-Dropout Linear Regulator with Programmable Soft-Start

The NCP59749 is dual-rail very low dropout voltage regulator that is capable of providing an output current in excess of 3.0 A with a dropout voltage of 120 mV typ. at full load current. The devices are stable with ceramic and any other type of output capacitor  $\geq 2.2 \mu\text{F}$ . This series contains adjustable output voltage version with output voltage down to 0.8 V. Internal protection features consist of built-in thermal shutdown and output current limiting protection. User-programmable Soft-Start and Power Good pins are available. The NCP59749 is available in QFN20 5x5 package.

### Features

- Output Current in Excess of 3.0 A
- $V_{\text{IN}}$  Range: 0.8 V to 5.5 V
- $V_{\text{BIAS}}$  Range: 2.7 V to 5.5 V
- Output Voltage Range: 0.8 V to 3.6 V
- Dropout Voltage: 120 mV at 3 A
- Programmable Soft Start
- Open Drain Power Good Output
- Fast Transient Response
- Stable with Any Type of Output Capacitor  $\geq 2.2 \mu\text{F}$
- Current Limit and Thermal Shutdown Protection
- These are Pb-Free Devices

### Applications

- Consumer and Industrial Equipment Point of Load Regulation
- FPGA, DSP and Logic Power Supplies
- Switching Power Supply Post Regulation

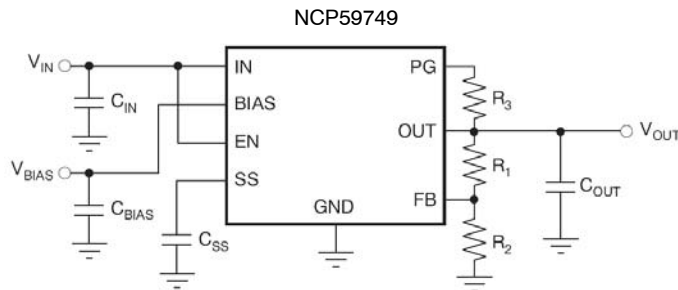
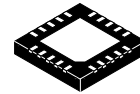

Figure 1. Typical Application Schematic



ON Semiconductor®

<http://onsemi.com>



QFN20  
CASE 485DB

### PIN CONNECTIONS

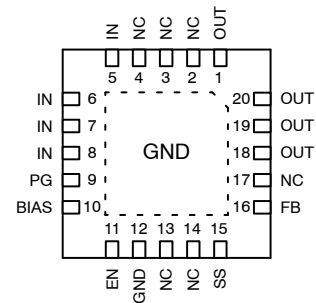

QFN20, 5x5, 0.65P

### MARKING DIAGRAM

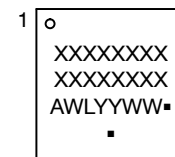

QFN20

XXXXX = Specific Device Code  
 A = Assembly Location  
 L/WL = Wafer Lot  
 Y/YY = Year  
 W/WW = Work Week  
 ■ = Pb-Free Package  
 (Note: Microdot may be in either location)

### ORDERING INFORMATION

See detailed ordering, marking and shipping information in the package dimensions section on page 9 of this data sheet.

# NCP59749

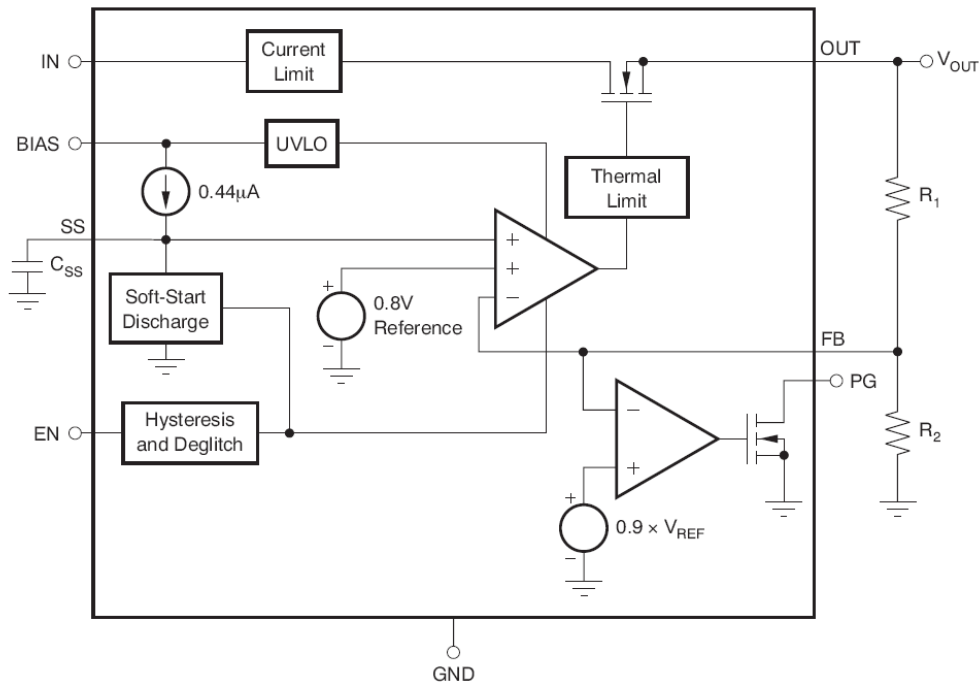

**Figure 2. Simplified Schematic Block Diagram**

**Table 1. PIN FUNCTION DESCRIPTION**

Name	QFN-20	Description
IN	5-8	Unregulated input to the device.
EN	11	Enable pin. Driving this pin high enables the regulator. Driving this pin low puts the regulator into shutdown mode. This pin must not be left floating.
SS	15	Soft-Start pin. A capacitor connected on this pin to ground sets the start-up time. If this pin is left floating, the regulator output soft-start ramp time is typically 200 µs.
BIAS	10	Bias input voltage for error amplifier, reference, and internal control circuits.
PG	9	Power-Good (PG) is an open-drain, active-high output that indicates the status of $V_{OUT}$ . When $V_{OUT}$ exceeds the PG trip threshold, the PG pin goes into a high-impedance state. When $V_{OUT}$ is below this threshold the pin is driven to a low-impedance state. A pull-up resistor from 10 kΩ to 1 MΩ should be connected from this pin to a supply up to 5.5 V. The supply can be higher than the input voltage. Alternatively, the PG pin can be left floating if output monitoring is not necessary.
FB	16	This pin is the feedback connection to the center tap of an external resistor divider network that sets the output voltage. This pin must not be left floating.
OUT	1, 18-20	Regulated output voltage. A small capacitor (total typical capacitance $\geq 2.2$ µF, ceramic) is needed from this pin to ground to assure stability.
NC	2-4, 13, 14, 17	No connection. This pin can be left floating or connected to GND to allow better thermal contact to the top-side plane.
GND	12	Ground
PAD/TAB		Should be soldered to the ground plane for increased thermal performance

**Table 2. ABSOLUTE MAXIMUM RATINGS**

Parameter	Symbol	Value	Unit
Input Voltage Range	$V_{IN}$	-0.3 to +6	V
Input Voltage Range	$V_{BIAS}$	-0.3 to +6	V
Enable Voltage Range	$V_{EN}$	-0.3 to +6	V
Power-Good Voltage Range	$V_{PG}$	-0.3 to +6	V
PG Sink Current	$I_{PG}$	0 to +1.5	mA
SS Pin Voltage Range	$V_{SS}$	-0.3 to +6	V
Feedback Pin Voltage Range	$V_{FB}$	-0.3 to +6	V
Output Voltage Range	$V_{OUT}$	-0.3 to $(V_{IN} + 0.3) \leq 6$	V
Maximum Output Current	$I_{OUT}$	Internally Limited	
Output Short Circuit Duration		Indefinite	
Continuous Total Power Dissipation	$P_D$	See Thermal Characteristics Table and Formula	
Maximum Junction Temperature	$T_{JMAX}$	+125	°C
Storage Junction Temperature Range	$T_{STG}$	-55 to +150	°C
ESD Capability, Human Body Model (Note 2)	$ESD_{HBM}$	2000	V
ESD Capability, Machine Model (Note 2)	$ESD_{MM}$	200	V

Stresses exceeding those listed in the Maximum Ratings table may damage the device. If any of these limits are exceeded, device functionality should not be assumed, damage may occur and reliability may be affected.

1. Refer to ELECTRICAL CHARACTERISTICS and APPLICATION INFORMATION for Safe Operating Area.
2. This device series incorporates ESD protection and is tested by the following methods:  
 ESD Human Body Model tested per EIA/JESD22-A114  
 ESD Machine Model tested per EIA/JESD22-A115  
 Latch-up Current Maximum Rating tested per JEDEC standard: JESD78.

**Table 3. THERMAL CHARACTERISTICS**

Rating	Symbol	Value	Unit
Thermal Characteristics, QFN20, 5x5, 0.65P package			
Thermal Resistance, Junction-to-Ambient (Note 5)	$R_{\theta JA}$	30.5	°C/W
Thermal Resistance, Junction-to-Case (bottom) (Note 6)	$R_{\theta JC}$	4.1	°C/W

3. Refer to ELECTRICAL CHARACTERISTICS and APPLICATION INFORMATION for Safe Operating Area.
4. Thermal data are derived by thermal simulations based on methodology specified in the JEDEC JESD51 series standards. The following assumptions are used in the simulations:
  - This data was generated with only a single device at the center of a high-K (2s2p) board with 3 in x 3 in copper area which follows the JEDEC51.7 guidelines.
  - The exposed pad is connected to the PCB ground layer through a 4x4 thermal via array. Vias are 0.3 mm diameter, plated.
  - Each of top and bottom copper layers has a dedicated pattern for 20% copper coverage.
5. The junction-to-ambient thermal resistance under natural convection is obtained in a simulation on a high-K board, following the JEDEC51.7 guidelines with assumptions as above, in an environment described in JESD51-2a.
6. The junction-to-case (bottom) thermal resistance is obtained by simulating a cold plate test on the IC exposed pad. Test description can be found in the ANSI SEMI standard G30-88.

**Table 4. RECOMMENDED OPERATING CONDITIONS** (Note 7)

Rating	Symbol	Min	Max	Unit
Input Voltage	$V_{IN}$	$V_{OUT} + V_{DO}$	5.5	V
Bias Voltage	$V_{BIAS}$	2.7	5.5	V
Junction Temperature	$T_J$	-40	125	°C

Functional operation above the stresses listed in the Recommended Operating Ranges is not implied. Extended exposure to stresses beyond the Recommended Operating Ranges limits may affect device reliability.

7. Refer to ELECTRICAL CHARACTERISTICS and APPLICATION INFORMATION for Safe Operating Area.

# NCP59749

**Table 5. ELECTRICAL CHARACTERISTICS**

(At  $V_{EN} = 1.1\text{ V}$ ,  $V_{IN} = V_{OUT} + 0.3\text{ V}$ ,  $C_{BIAS} = 0.1\text{ }\mu\text{F}$ ,  $C_{SS} = 1\text{ nF}$ ,  $C_{IN} = C_{OUT} = 10\text{ }\mu\text{F}$ ,  $I_{OUT} = 50\text{ mA}$ ,  $V_{BIAS} = 5.0\text{ V}$ ,  $T_J = -40^\circ\text{C}$  to  $+125^\circ\text{C}$ , unless otherwise noted. Typical values are at  $T_J = +25^\circ\text{C}$ .)

Symbol	Parameter	Test Conditions	Min	Typ	Max	Unit
$V_{IN}$	Input Voltage Range		$V_{OUT} + V_{DO}$		5.5	V
$V_{BIAS}$	Bias Pin Voltage Range		2.7		5.5	V
UVLO	Undervoltage Lock-out	$V_{BIAS}$ rising Hysteresis	1.2	1.6 0.4	1.9	V
$V_{REF}$	Internal Reference (Adj.)	$T_J = +25^\circ\text{C}$	0.798	0.802	0.806	V
$V_{OUT}$	Output Voltage Range	$V_{IN} = 5\text{ V}$ , $I_{OUT} = 3.0\text{ A}$	$V_{REF}$		3.6	V
	Accuracy (Note 1)	$V_{OUT} + 2.2\text{ V} < V_{BIAS} < 5.5\text{ V}$ , $50\text{ mA} < I_{OUT} < 3.0\text{ A}$	- 2	$\pm 0.5$	+ 2	%
$V_{OUT}/V_{IN}$	Line Regulation	$V_{OUT}(\text{NOM}) + 0.3 < V_{IN} < 5.5\text{ V}$		0.03		%/V
$V_{OUT}/I_{OUT}$	Load Regulation	$50\text{ mA} < I_{OUT} < 3.0\text{ A}$		0.09		%/A
$V_{DO}$	$V_{IN}$ Dropout Voltage (Note 2)	$I_{OUT} = 3.0\text{ A}$ , $V_{BIAS} - V_{OUT}(\text{NOM}) \geq 3.25\text{ V}$ (Note 3)		120	280	mV
	$V_{BIAS}$ Dropout Voltage (Note 2)	$I_{OUT} = 3.0\text{ A}$ , $V_{IN} = V_{BIAS}$		1.31	1.75	V
$I_{CL}$	Current Limit	$V_{OUT} = 80\% \times V_{OUT}(\text{NOM})$	3.8	4.6	6.0	A
$I_{BIAS}$	Bias Pin Current			1	2	mA
$I_{SHDN}$	Shutdown Supply Current ( $I_{GND}$ )	$V_{EN} \leq 0.4\text{ V}$		1	50	$\mu\text{A}$
$I_{FB}$	Feedback Pin Current		- 1	0.15	1	$\mu\text{A}$
PSRR	Power-supply Rejection ( $V_{IN}$ to $V_{OUT}$ )	1 kHz, $I_{OUT} = 1.5\text{ A}$ , $V_{IN} = 1.8\text{ V}$ , $V_{OUT} = 1.5\text{ V}$		60		dB
		300 kHz, $I_{OUT} = 1.5\text{ A}$ , $V_{IN} = 1.8\text{ V}$ , $V_{OUT} = 1.5\text{ V}$		30		
	Power-supply Rejection ( $V_{BIAS}$ to $V_{OUT}$ )	1 kHz, $I_{OUT} = 1.5\text{ A}$ , $V_{IN} = 1.8\text{ V}$ , $V_{OUT} = 1.5\text{ V}$		50		dB
		300 kHz, $I_{OUT} = 1.5\text{ A}$ , $V_{IN} = 1.8\text{ V}$ , $V_{OUT} = 1.5\text{ V}$		30		
Noise	Output Noise Voltage	100 Hz to 100 kHz, $I_{OUT} = 3\text{ A}$		$25 \times V_{OUT}$		$\mu\text{V}_{\text{RMS}}$
$t_{\text{STRT}}$	Minimum Startup Time	$R_{\text{LOAD}}$ for $I_{OUT} = 1.0\text{ A}$ , $C_{SS} = \text{open}$		200		$\mu\text{s}$
$I_{SS}$	Soft-start Charging Current	$V_{SS} = 0.4\text{ V}$		0.44		$\mu\text{A}$
$V_{\text{EN, HI}}$	Enable Input High Level		1.1		5.5	V
$V_{\text{EN, LO}}$	Enable Input Low Level		0		0.4	V
$V_{\text{EN, HYS}}$	Enable Pin Hysteresis			50		mV
$V_{\text{EN, DG}}$	Enable Pin Deglitch Time			20		$\mu\text{s}$
$I_{\text{EN}}$	Enable Pin Current	$V_{\text{EN}} = 5\text{ V}$		0.1	1	$\mu\text{A}$
$V_{\text{IT}}$	PG Trip Threshold	$V_{\text{OUT}}$ decreasing	85	90	94	% $V_{\text{OUT}}$
$V_{\text{HYS}}$	PG Trip Hysteresis			3		% $V_{\text{OUT}}$
$V_{\text{PG, LO}}$	PG Output Low Voltage	$I_{\text{PG}} = 1\text{ mA}$ (Sinking), $V_{\text{OUT}} < V_{\text{IT}}$			0.3	V
$I_{\text{PG, LKG}}$	PG Leakage Current	$V_{\text{PG}} = 5.25\text{ V}$ , $V_{\text{OUT}} > V_{\text{IT}}$		0.1	1	$\mu\text{A}$
TSD	Thermal Shutdown Temperature	Shutdown, temperature increasing		+165		$^\circ\text{C}$
		Reset, temperature decreasing		+140		

Product parametric performance is indicated in the Electrical Characteristics for the listed test conditions, unless otherwise noted. Product performance may not be indicated by the Electrical Characteristics if operated under different conditions.

- Adjustable devices tested at  $V_{REF}$ ; external resistor tolerance is not taken into account.
- Dropout is defined as the voltage from the input to  $V_{OUT}$  when  $V_{OUT}$  is 3% below nominal.
- 3.25 V is a test condition of this device and can be adjusted by referring to Figure 8.

TYPICAL CHARACTERISTICS

At  $T_J = +25^\circ\text{C}$ ,  $V_{IN} = V_{OUT(TYP)} + 0.3\text{ V}$ ,  $V_{BIAS} = 5\text{ V}$ ,  $I_{OUT} = 50\text{ mA}$ ,  $V_{EN} = V_{IN}$ ,  
 $C_{IN} = 1\ \mu\text{F}$ ,  $C_{BIAS} = 4.7\ \mu\text{F}$ , and  $C_{OUT} = 10\ \mu\text{F}$ , unless otherwise noted.

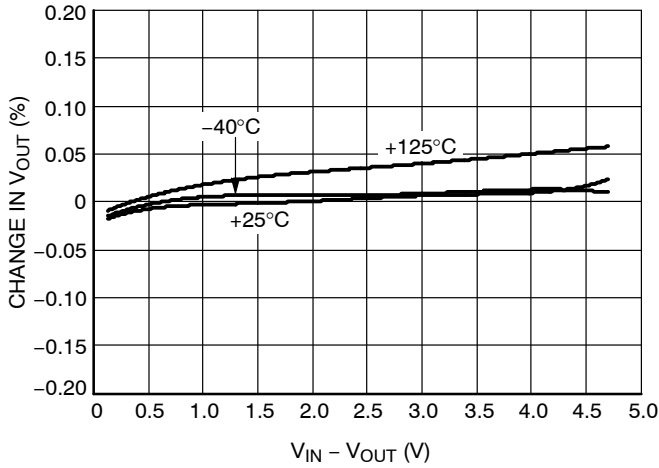

Figure 3.  $V_{IN}$  Line Regulation

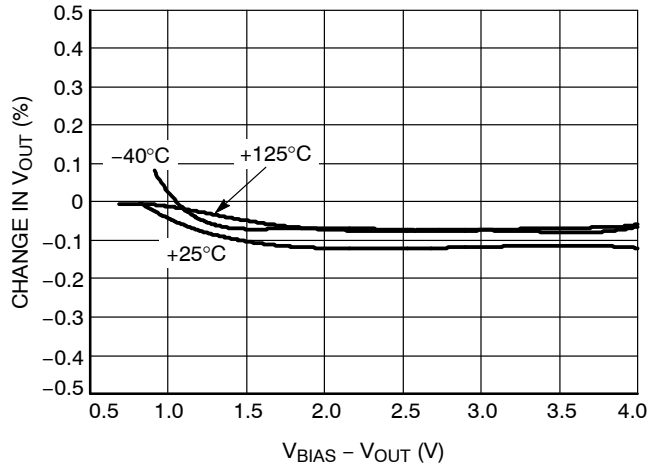

Figure 4.  $V_{BIAS}$  Line Regulation

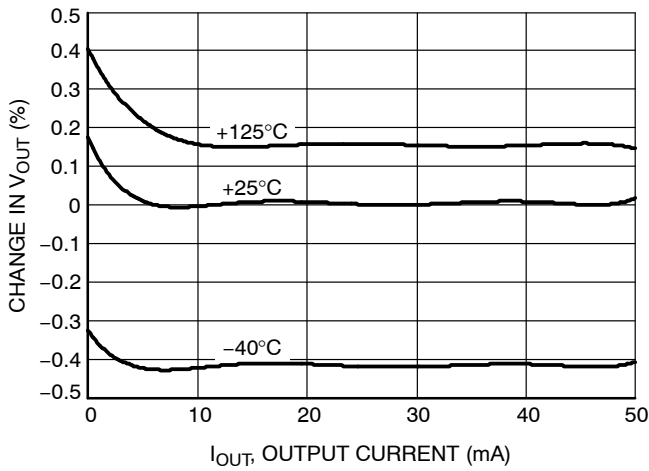

Figure 5. Load Regulation

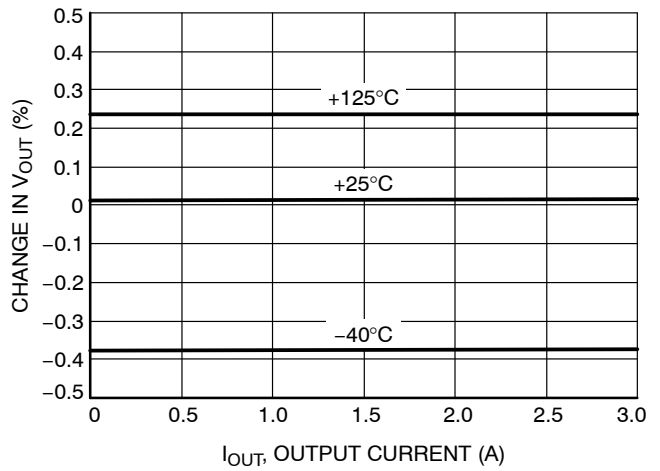

Figure 6. Load Regulation

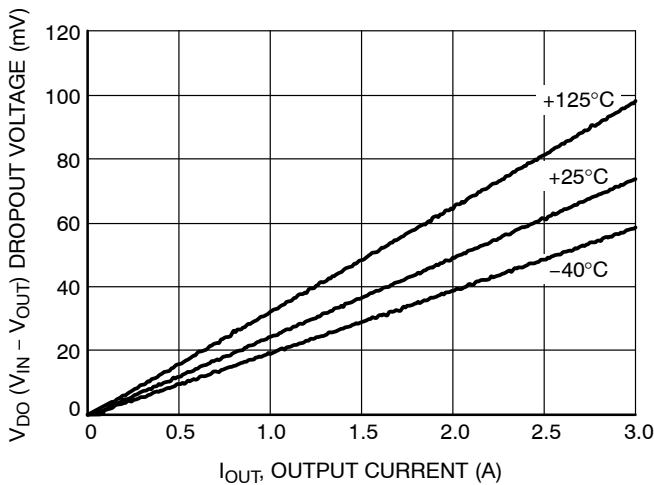

Figure 7.  $V_{IN}$  Dropout Voltage vs.  $I_{OUT}$  and Temperature  $T_J$

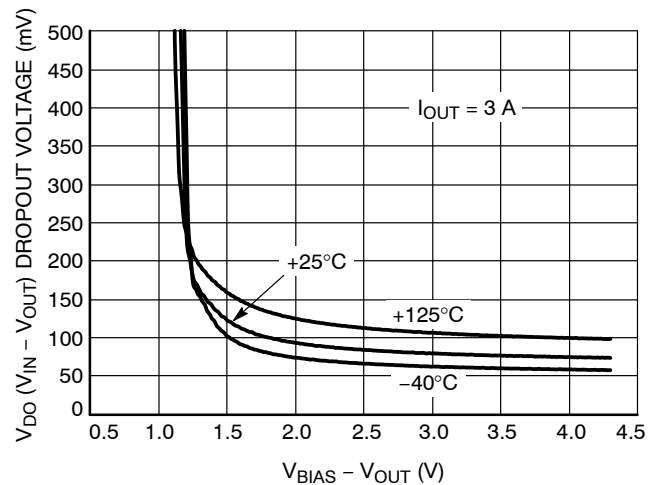

Figure 8.  $V_{IN}$  Dropout Voltage vs.  $(V_{BIAS} - V_{OUT})$  and Temperature  $T_J$

TYPICAL CHARACTERISTICS

At  $T_J = +25^\circ\text{C}$ ,  $V_{IN} = V_{OUT(TYP)} + 0.3\text{ V}$ ,  $V_{BIAS} = 5\text{ V}$ ,  $I_{OUT} = 50\text{ mA}$ ,  $V_{EN} = V_{IN}$ ,  
 $C_{IN} = 1\ \mu\text{F}$ ,  $C_{BIAS} = 4.7\ \mu\text{F}$ , and  $C_{OUT} = 10\ \mu\text{F}$ , unless otherwise noted.

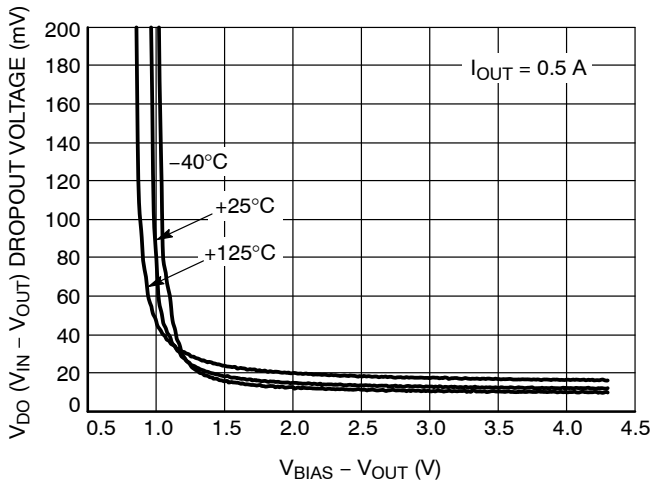

Figure 9.  $V_{IN}$  Dropout Voltage vs.  $(V_{BIAS} - V_{OUT})$  and Temperature  $T_J$

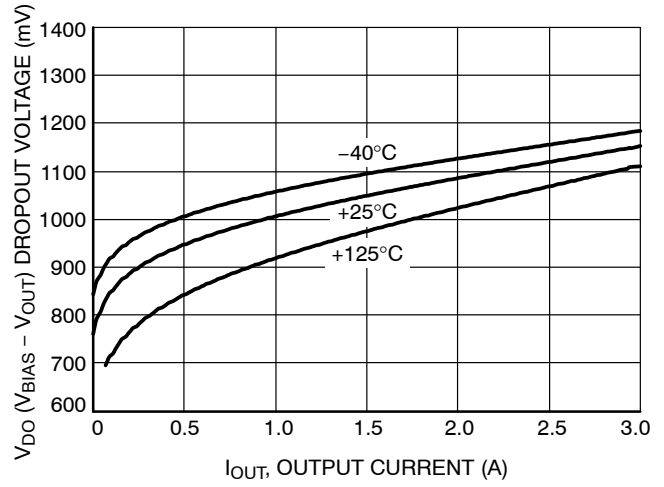

Figure 10.  $V_{BIAS}$  Dropout Voltage vs.  $I_{OUT}$  and Temperature  $T_J$

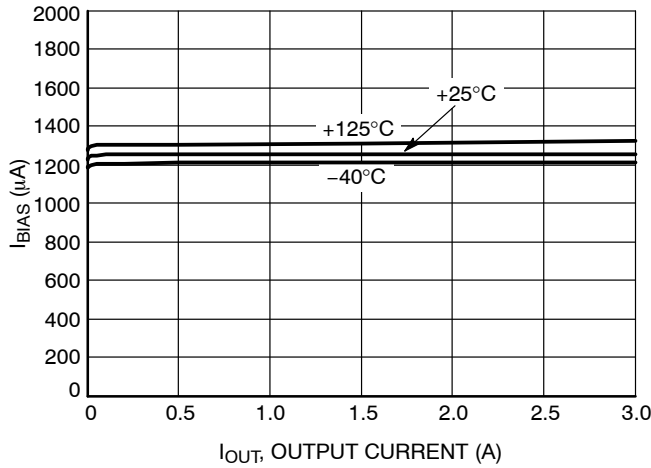

Figure 11. BIAS Pin Current vs.  $I_{OUT}$  and Temperature  $T_J$

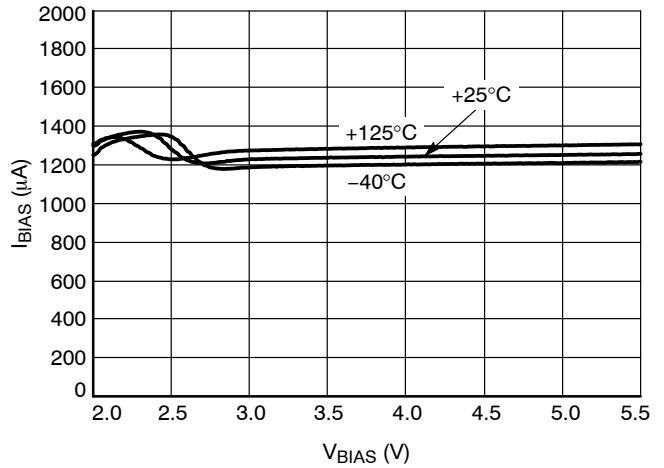

Figure 12. BIAS Pin Current vs.  $V_{BIAS}$  and Temperature  $T_J$

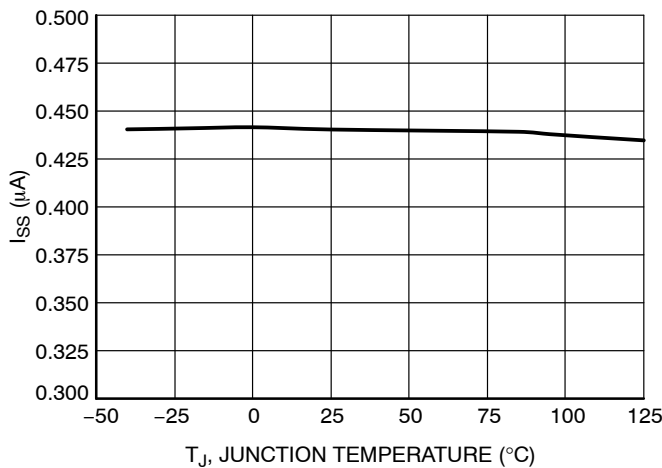

Figure 13. Soft Start Charging Current  $I_{SS}$  vs. Temperature  $T_J$

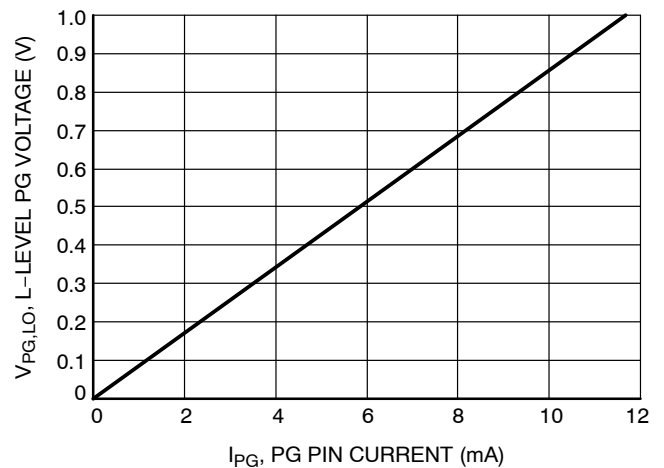

Figure 14. L-level PG Voltage vs. Current

# NCP59749

## TYPICAL CHARACTERISTICS

At  $T_J = +25^\circ\text{C}$ ,  $V_{IN} = V_{OUT(TYP)} + 0.3\text{ V}$ ,  $V_{BIAS} = 5\text{ V}$ ,  $I_{OUT} = 50\text{ mA}$ ,  $V_{EN} = V_{IN}$ ,  
 $C_{IN} = 1\ \mu\text{F}$ ,  $C_{BIAS} = 4.7\ \mu\text{F}$ , and  $C_{OUT} = 10\ \mu\text{F}$ , unless otherwise noted.

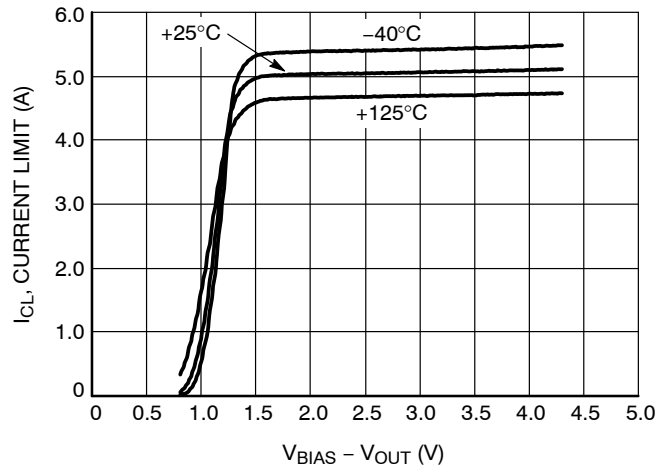

Figure 15. Current Limit vs. (V<sub>BIAS</sub> - V<sub>OUT</sub>)

APPLICATIONS INFORMATION

The NCP59749 dual-rail very low dropout voltage regulator is using NMOS pass transistor for output voltage regulation from  $V_{IN}$  voltage. All the low current internal control circuitry is powered from the  $V_{BIAS}$  voltage.

The use of an NMOS pass transistor offers several advantages in applications. Unlike a PMOS topology devices, the output capacitor has reduced impact on loop stability.  $V_{in}$  to  $V_{out}$  operating voltage difference can be very low compared with standard PMOS regulators in very low  $V_{in}$  applications.

The NCP59749 offers programmable smooth monotonic start-up. The controlled voltage rising limits the inrush current what is advantageous in applications with large capacitive loads. The Voltage Controlled Soft Start timing is programmable by external  $C_{SS}$  capacitor value.

The Enable (EN) input is equipped with internal hysteresis and deglitch filter.

Open Drain type Power Good (PG) output is available for  $V_{out}$  monitoring and sequencing of other devices.

NCP59749 is a Adjustable linear regulator. The required Output voltage can be adjusted by two external resistors. Typical application schematics is shown in Figure 16.

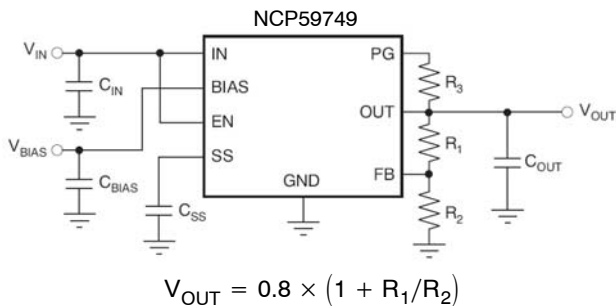

Figure 16. Typical Application Schematics

**Dropout Voltage**

Because of two power supply inputs  $V_{IN}$  and  $V_{BIAS}$  and one  $V_{OUT}$  regulator output, there are two Dropout voltages specified.

The first, the  $V_{IN}$  Dropout voltage is the voltage difference ( $V_{IN} - V_{OUT}$ ) when  $V_{OUT}$  starts to decrease by percents specified in the Electrical Characteristics table.  $V_{BIAS}$  is high enough, specific value is published in the Electrical Characteristics table.

The second,  $V_{BIAS}$  dropout voltage is the voltage difference ( $V_{BIAS} - V_{OUT}$ ) when  $V_{IN}$  and  $V_{BIAS}$  pins are joined together and  $V_{OUT}$  starts to decrease.

**Input and Output Capacitors**

The device is designed to be stable for all available types and values of output capacitors  $\geq 2.2 \mu F$ . The device is also stable with multiple capacitors in parallel, which can be of any type or value.

In applications where no low input supplies impedance available (PCB inductance in  $V_{IN}$  and/or  $V_{BIAS}$  inputs as

example), the recommended  $C_{IN}$  and  $C_{BIAS}$  value is  $1 \mu F$  or greater. Ceramic or other low ESR capacitors are recommended. For the best performance all the capacitors should be connected to the NCP59749 respective pins directly in the device PCB copper layer, not through vias having not negligible impedance.

**Enable Operation**

The enable pin will turn the regulator on or off. The threshold limits are covered in the electrical characteristics table in this data sheet. If the enable function is not to be used then the pin should be connected to  $V_{IN}$  or  $V_{BIAS}$ .

**Output Noise**

When the NCP59749 device reaches the end of the Soft-Start cycle, the Soft Start capacitor is switched to serve as a Noise filtering capacitor.

**Output Voltage Adjust**

The output voltage can be adjusted from 0.8 V to 3.6 V using resistors divider between the output and the FB input. Recommended resistor values for frequently used voltages can be found in the Table 6.

**Programmable Soft-Start**

The Soft-Start ramp time depends on the Soft Start charging current  $I_{SS}$ , Soft-Start capacitor value  $C_{SS}$  and internal reference voltage  $V_{REF}$ .

The Soft -Start time can be calculated using following equations:

$$t_{SS} = C_{SS} \times (V_{REF} / I_{SS}) [s, F, V, A]$$

or in more practical units

$$t_{SS} = C_{SS} \times 0.8V / 0.44 = C_{SS} \times 1.82$$

where

$t_{SS}$  = Soft-Start time in milliseconds

$C_{SS}$  = Soft-Start capacitor value in nano Farads

Capacitor values for frequently used Soft-Start times can be found in the Table 7.

The maximal recommended value of  $C_{SS}$  capacitor is 15 nF. For higher  $C_{SS}$  values the capacitor full discharging before new Soft-Start cycle is not guaranteed.

**Current Limitation**

The internal Current Limitation circuitry allows the device to supply the full nominal current and surges but protects the device against Current Overload or Short.

**Thermal Protection**

Internal thermal shutdown (TSD) circuitry is provided to protect the integrated circuit in the event that the maximum junction temperature is exceeded. When TSD activated, the regulator output turns off. When cooling down under the low temperature threshold, device output is activated again. This TSD feature is provided to prevent failures from accidental overheating.



# NCP59749

**Table 6. RESISTOR VALUES FOR PROGRAMMING THE OUTPUT VOLTAGE**

V <sub>OUT</sub> (V)	R <sub>1</sub> (kΩ)	R <sub>2</sub> (kΩ)
0.8	Short	Open
0.9	0.619	4.99
1.0	1.13	4.53
1.05	1.37	4.33
1.1	1.87	4.99
1.2	2.49	4.99
1.5	4.12	4.75
1.8	3.57	2.87
2.5	3.57	1.69
3.3	3.57	1.15

NOTE:  $V_{OUT} = 0.8 \times (1 + R_1/R_2)$   
Resistors in the table are standard 1% types

**Table 7. CAPACITOR VALUES FOR PROGRAMMING THE SOFT-START TIME**

Soft-Start Time	C <sub>SS</sub>
0.2 ms	Open
0.5 ms	270 pF
1 ms	560 pF
5 ms	2.7 nF
10 ms	5.6 nF
18 ms	10 nF

**Table 8. ORDERING INFORMATION**

Device	Output Current	Output Voltage	Junction Temp. Range	Package	Shipping
NCP59749MN2ADJTBG	3.0 A	ADJ	-40°C to +125°C	QFN20	3000 / Tape & Reel

# NCP59749

## PACKAGE DIMENSIONS

QFN20 5x5, 0.65P  
CASE 485DB  
ISSUE O

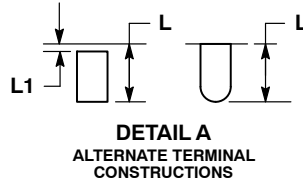
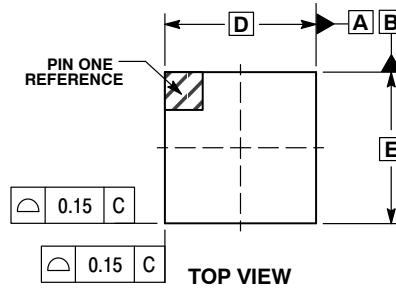

**NOTES:**

1. DIMENSIONS AND TOLERANCING PER ASME Y14.5M, 1994.
2. CONTROLLING DIMENSION: MILLIMETERS.
3. DIMENSION b APPLIES TO PLATED TERMINAL AND IS MEASURED BETWEEN 0.25 AND 0.30 MM FROM THE TERMINAL TIP.
4. COPLANARITY APPLIES TO THE EXPOSED PAD AS WELL AS THE TERMINALS.
5. OPTIONAL FEATURES.

MILLIMETERS		
DIM	MIN	MAX
A	0.80	1.00
A1	---	0.05
A3	0.20	REF
b	0.25	0.35
D	5.00	BSC
D2	3.05	3.25
E	5.00	BSC
E2	3.05	3.25
e	0.65	BSC
L	0.45	0.65
L1	---	0.15

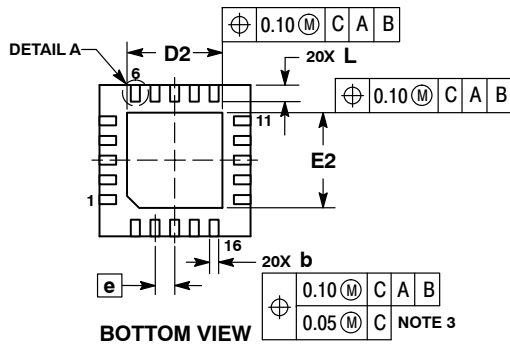
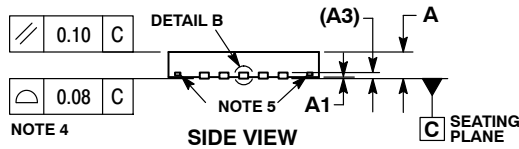

**RECOMMENDED  
SOLDERING FOOTPRINT\***

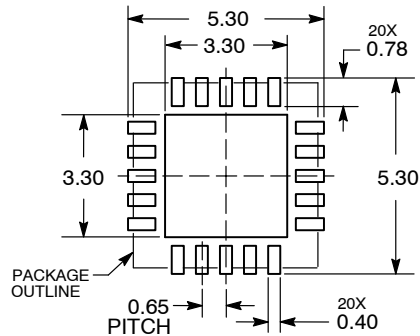

\*For additional information on our Pb-Free strategy and soldering details, please download the ON Semiconductor Soldering and Mounting Techniques Reference Manual, SOLDERRM/D.

ON Semiconductor and are registered trademarks of Semiconductor Components Industries, LLC (SCILLC). SCILLC owns the rights to a number of patents, trademarks, copyrights, trade secrets, and other intellectual property. A listing of SCILLC's product/patent coverage may be accessed at [www.onsemi.com/site/pdf/Patent-Marking.pdf](http://www.onsemi.com/site/pdf/Patent-Marking.pdf). SCILLC reserves the right to make changes without further notice to any products herein. SCILLC makes no warranty, representation or guarantee regarding the suitability of its products for any particular purpose, nor does SCILLC assume any liability arising out of the application or use of any product or circuit, and specifically disclaims any and all liability, including without limitation special, consequential or incidental damages. "Typical" parameters which may be provided in SCILLC data sheets and/or specifications can and do vary in different applications and actual performance may vary over time. All operating parameters, including "Typicals" must be validated for each customer application by customer's technical experts. SCILLC does not convey any license under its patent rights nor the rights of others. SCILLC products are not designed, intended, or authorized for use as components in systems intended for surgical implant into the body, or other applications intended to support or sustain life, or for any other application in which the failure of the SCILLC product could create a situation where personal injury or death may occur. Should Buyer purchase or use SCILLC products for any such unintended or unauthorized application, Buyer shall indemnify and hold SCILLC and its officers, employees, subsidiaries, affiliates, and distributors harmless against all claims, costs, damages, and expenses, and reasonable attorney fees arising out of, directly or indirectly, any claim of personal injury or death associated with such unintended or unauthorized use, even if such claim alleges that SCILLC was negligent regarding the design or manufacture of the part. SCILLC is an Equal Opportunity/Affirmative Action Employer. This literature is subject to all applicable copyright laws and is not for resale in any manner.

**PUBLICATION ORDERING INFORMATION**

**LITERATURE FULFILLMENT:**  
Literature Distribution Center for ON Semiconductor  
P.O. Box 5163, Denver, Colorado 80217 USA  
**Phone:** 303-675-2175 or 800-344-3860 Toll Free USA/Canada  
**Fax:** 303-675-2176 or 800-344-3867 Toll Free USA/Canada  
**Email:** [orderlit@onsemi.com](mailto:orderlit@onsemi.com)

**N. American Technical Support:** 800-282-9855 Toll Free  
USA/Canada  
**Europe, Middle East and Africa Technical Support:**  
Phone: 421 33 790 2910  
**Japan Customer Focus Center**  
Phone: 81-3-5817-1050

**ON Semiconductor Website:** [www.onsemi.com](http://www.onsemi.com)  
**Order Literature:** <http://www.onsemi.com/orderlit>  
For additional information, please contact your local Sales Representative