



FEATURES

- UL 60950 recognised
- Wide temperature performance at full 1 watt load, -40°C to 60°C
- Single and dual outputs
- SIP package style
- 5.2kVDC isolation 'Hi Pot Test'
- 3V, 5V & 12V input
- 3V, 5V, 9V, 12V and 15V output
- Internal SMD construction
- Pin compatible with the CRV1, NMV, MEV1, MMV1, MEJ1 series SIP DC/DC converters
- MTTF up to 13 million hours
- Custom solutions available

PRODUCT OVERVIEW

The NMJ series are dual and single output DC/DC converters in a 7 pin SIP package style offering pin and functionality compatibility with the NMV series SIP DC/DC converters. The NMJ series is UL60950 recognized and suitable for applications where safety and miniaturisation are of paramount importance. Isolation barrier approved for supplementary/reinforced insulation - see page 2.

SELECTION GUIDE

| Order Code | Nominal Input Voltage | Output Voltage | Output Current | Ripple & Noise ² | Efficiency (Min.) | Isolation Capacitance | MTTF ¹ |
|------------|-----------------------|----------------|----------------|-----------------------------|-------------------|-----------------------|-------------------|
| | V | V | mA | mV p-p | % | pF | kHrs |
| NMJ0505SC | 5 | ±5 | ±100 | 40 | 60 | 3.0 | 4950 |
| NMJ0509SC | 5 | ±9 | ±55 | 30 | 65 | 3.0 | 3832 |
| NMJ0512SC | 5 | ±12 | ±42 | 20 | 65 | 3.0 | 2770 |
| NMJ0515SC | 5 | ±15 | ±33 | 20 | 65 | 3.0 | 1903 |
| NMJ1205SC | 12 | ±5 | ±100 | 40 | 60 | 3.0 | 3688 |
| NMJ1209SC | 12 | ±9 | ±55 | 30 | 65 | 3.0 | 3029 |
| NMJ1212SC | 12 | ±12 | ±42 | 20 | 65 | 3.0 | 2324 |
| NMJ1215SC | 12 | ±15 | ±33 | 20 | 65 | 3.0 | 1682 |
| NMJ0303SAC | 3.3 | 3.3 | 303 | 70 | 66 | 3.0 | 13780 |
| NMJ0503SAC | 5 | 3.3 | 303 | 60 | 64 | 3.0 | 13460 |
| NMJ0505SAC | 5 | 5 | 200 | 50 | 68 | 3.0 | 13360 |
| NMJ0509SAC | 5 | 9 | 111 | 50 | 72 | 3.0 | 12700 |
| NMJ0512SAC | 5 | 12 | 83 | 50 | 71 | 3.0 | 11490 |
| NMJ0515SAC | 5 | 15 | 66 | 50 | 71 | 3.0 | 9980 |
| NMJ1205SAC | 12 | 5 | 200 | 50 | 69 | 3.0 | 8447 |
| NMJ1209SAC | 12 | 9 | 111 | 50 | 73 | 3.0 | 8176 |
| NMJ1212SAC | 12 | 12 | 83 | 50 | 73 | 3.0 | 7660 |
| NMJ1215SAC | 12 | 15 | 66 | 50 | 74 | 3.0 | 6950 |

INPUT CHARACTERISTICS

| Parameter | Conditions | Min. | Typ. | Max. | Units |
|---------------|---------------------------------------|------|------|------|-------|
| Voltage range | Continuous operation, 3V input types | 2.97 | 3.3 | 3.63 | V |
| | Continuous operation, 5V input types | 4.5 | 5 | 5.5 | |
| | Continuous operation, 12V input types | 10.8 | 12 | 13.2 | |

OUTPUT CHARACTERISTICS

| Parameter | Conditions | Min. | Typ. | Max. | Units |
|-----------------------------|--|------|------|------|-------|
| Rated Power | T _A = -40°C to 60°C, see derating graph | | | 1 | W |
| Voltage Set Point Accuracy | See tolerance envelopes | | | | |
| Line regulation | High V _{IN} to low V _{IN} | | 1.0 | 1.2 | %/% |
| Load regulation | 10% load to rated load, xx03 | | 10.0 | 15.0 | % |
| | 10% load to rated load, 0505 | | 7.0 | 10.0 | |
| | 10% load to rated load, 0509, 0512, 0515 | | 6.0 | 10.0 | |
| Load regulation | 10% load to rated load, 12xx | | 5.0 | 7.0 | % |
| | 10% load to rated load, 5V output types | | 10.0 | 15.0 | |
| | 10% load to rated load, 9V output types | | 6.0 | 10.0 | |
| | 10% load to rated load, 12V output types | | 6.0 | 10.0 | |
| Zero Load Power Consumption | 10% load to rated load, 15V output types | | 6.0 | 10.0 | % |
| | All types | | 250 | | |

ABSOLUTE MAXIMUM RATINGS

| | |
|---|-------|
| Lead temperature 1.5mm from case for 10 seconds | 260°C |
| Input voltage V _{IN} , NMJ03 types | 5V |
| Input voltage V _{IN} , NMJ05 types | 7V |
| Input voltage V _{IN} , NMJ12 types | 15V |

1. Calculated using MIL-HDBK-217 FN2 calculation model with nominal input voltage at full load.
 2. See ripple & noise test method.
- All specifications typical at T_A=25°C, nominal input voltage and rated output current unless otherwise specified.



ISOLATION CHARACTERISTICS

| Parameter | Conditions | Min. | Typ. | Max. | Units |
|------------------------|---------------------------|------|------|------|-------|
| Isolation test voltage | Flash tested for 1 second | 5200 | | | VDC |
| Resistance | Viso= 500VDC | | 1 | | GΩ |

GENERAL CHARACTERISTICS

| Parameter | Conditions | Min. | Typ. | Max. | Units |
|---------------------|---------------|------|------|------|-------|
| Switching frequency | Single output | | 45 | | kHz |
| | Dual output | | 70 | | |

TEMPERATURE CHARACTERISTICS

| Parameter | Conditions | Min. | Typ. | Max. | Units |
|--------------------------------|---------------------|------|------|------|-------|
| Specification | All output types | -40 | | 60 | °C |
| Storage | | -55 | | 130 | |
| Case Temperature above ambient | All output types | | | 33 | |
| Cooling | Free air convection | | | | |

TEMPERATURE DERATING GRAPH

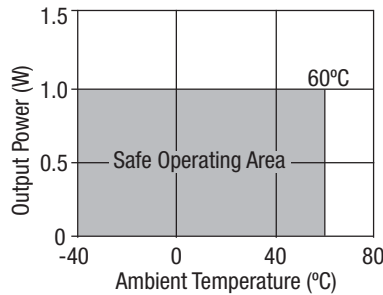

TECHNICAL NOTES

ISOLATION VOLTAGE

'Hi Pot Test', 'Flash Tested', 'Withstand Voltage', 'Proof Voltage', 'Dielectric Withstand Voltage' & 'Isolation Test Voltage' are all terms that relate to the same thing, a test voltage, applied for a specified time, across a component designed to provide electrical isolation, to verify the integrity of that isolation.

Murata Power Solutions NMJ series of DC/DC converters are all 100% production tested at their stated isolation voltage. This is 5.2kVDC for 1 second.

A question commonly asked is, "What is the continuous voltage that can be applied across the part in normal operation?"

The NMJ series has been recognized by Underwriters Laboratory to 300Vrms for Supplementary Insulation and 150Vrms for Reinforced Insulation.

REPEATED HIGH-VOLTAGE ISOLATION TESTING

It is well known that repeated high-voltage isolation testing of a barrier component can actually degrade isolation capability, to a lesser or greater degree depending on materials, construction and environment. We therefore strongly advise against repeated high voltage isolation testing, but if it is absolutely required, that the voltage be reduced by 20% from specified test voltage.

SAFETY APPROVAL

The NMJ series has been recognised by Underwriters Laboratory (UL) to UL 60950 for supplementary insulation up to 300Vrms and reinforced insulation up to 150Vrms at a maximum ambient temperature of 60°C. File number E151252 applies.

RoHS COMPLIANCE INFORMATION



This series is compatible with RoHS soldering systems with a peak wave solder temperature of 260°C for 10 seconds. The pin termination finish on this product series is Tin Plate, Hot Dipped over Matte Tin with Nickel Preplate. The series is backward compatible with Sn/Pb soldering systems.

For further information, please visit www.murata-ps.com/rohs

APPLICATION NOTES

Minimum load

The minimum load to meet datasheet specification is 10% of the full rated load across the specified input voltage range. Lower than 10% minimum loading will result in an increase in output voltage, which may rise to typically double the specified output voltage if the output load falls to less than 5%.

Capacitive loading and start up

Typical start up times for this series, with a typical input voltage rise time of 2.2µs and output capacitance of 10µF, are shown in the table below. The product series will start into a capacitance of 47µF with an increased start time, however, the maximum recommended output capacitance is 10µF.

| Start-up time | | Start-up time | |
|---------------|-------|---------------|-------|
| µs | | µs | |
| NMJ0505SC | 2530 | NMJ0505SAC | 1059 |
| NMJ0509SC | 7865 | NMJ0509SAC | 3454 |
| NMJ0512SC | 13080 | NMJ0512SAC | 7980 |
| NMJ0515SC | 21560 | NMJ0515SAC | 11505 |
| NMJ1205SC | 2770 | NMJ1205SAC | 1286 |
| NMJ1209SC | 20455 | NMJ1209SAC | 3548 |
| NMJ1212SC | 14475 | NMJ1212SAC | 7355 |
| NMJ1215SC | 22300 | NMJ1215SAC | 11535 |
| NMJ0303SAC | 530 | | |
| NMJ0503SAC | 576 | | |

Typical Start-Up Wave Form

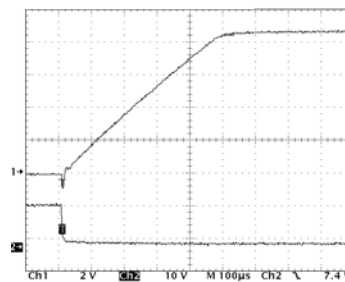

Ripple & Noise Characterisation Method

Ripple and noise measurements are performed with the following test configuration.

| | |
|-------|--|
| C1 | 1µF X7R multilayer ceramic capacitor, voltage rating to be a minimum of 3 times the output voltage of the DC/DC converter |
| C2 | 10µF tantalum capacitor, voltage rating to be a minimum of 1.5 times the output voltage of the DC/DC converter with an ESR of less than 100mΩ at 100 kHz |
| C3 | 100nF multilayer ceramic capacitor, general purpose |
| R1 | 450Ω resistor, carbon film, ±1% tolerance |
| R2 | 50Ω BNC termination |
| T1 | 3T of the coax cable through a ferrite toroid |
| RLOAD | Resistive load to the maximum power rating of the DC/DC converter. Connections should be made via twisted wires |

Measured values are multiplied by 10 to obtain the specified values.

Differential Mode Noise Test Schematic

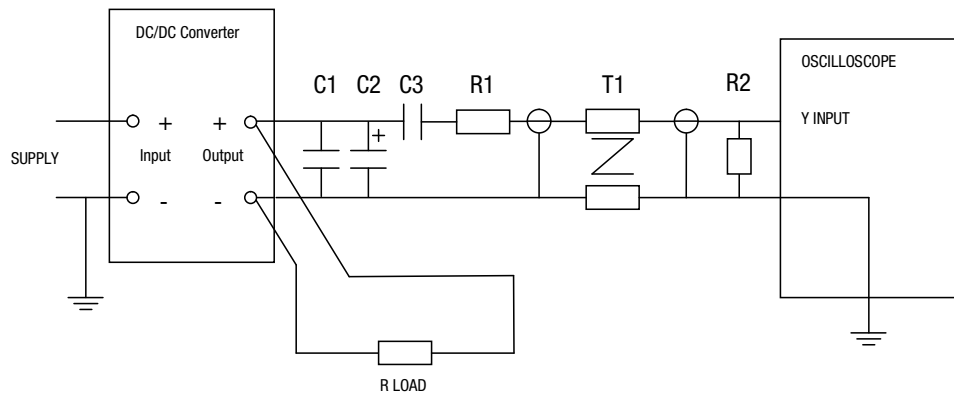

APPLICATION NOTES (continued)

Output Ripple Reduction

By using the values of inductance and capacitance stated, the output ripple at the rated load is lowered to 5mV p-p max.

Component selection

Capacitor: It is required that the ESR (Equivalent Series Resistance) should be as low as possible, ceramic types are recommended. The voltage rating should be at least twice (except for 15V output), the rated output voltage of the DC/DC converter.

Inductor: The rated current of the inductor should not be less than that of the output of the DC/DC converter. At the rated current, the DC resistance of the inductor should be such that the voltage drop across the inductor is <2% of the rated voltage of the DC/DC converter. The SRF (Self Resonant Frequency) should be >20MHz.

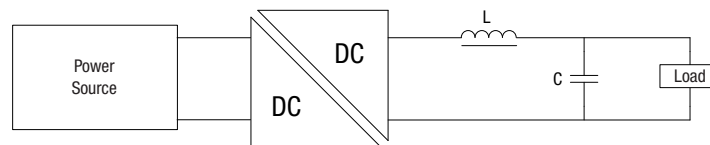

| | Inductor | | | Capacitor |
|--------------------------|------------|--------------|--------|------------|
| | L, μ H | Through Hole | SMD | C, μ F |
| 3.3V single output types | 22 | 22R223C | 82223C | 4.7 |
| 5V single output types | 22 | 22R223C | 82223C | 4.7 |
| 9V single output types | 47 | 22R473C | 82473C | 2.2 |
| 12V single output types | 220 | 22R224C | 82224C | 0.47 |
| 15V single output types | 220 | 22R224C | 82224C | 0.47 |

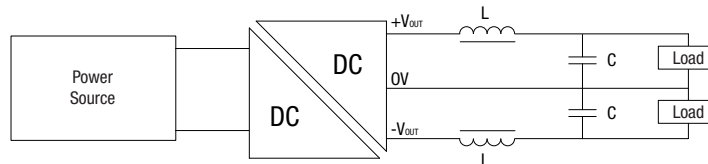

| | Inductor | | | Capacitor |
|-----------------------|------------|--------------|--------|------------|
| | L, μ H | Through Hole | SMD | C, μ F |
| 5V dual output types | 22 | 22R223C | 82223C | 4.70 |
| 9V dual output types | 47 | 22R473C | 82473C | 2.2 |
| 12V dual output types | 220 | 22R224C | 82224C | 0.47 |
| 15V dual output types | 220 | 22R224C | 82224C | 0.47 |

TOLERANCE ENVELOPES

The voltage tolerance envelopes show typical load regulation characteristics for this product series. The tolerance envelope is the maximum output voltage variation due to changes in output loading and set point accuracy.

3.3, 5, 9, 12 & 15V output types

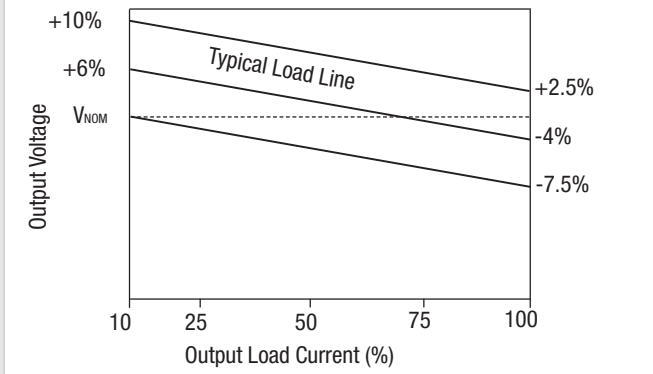

NMJ0303SAC

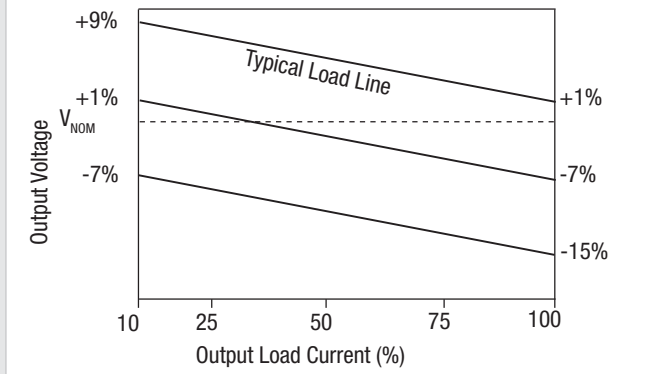

PACKAGE SPECIFICATIONS

MECHANICAL DIMENSIONS

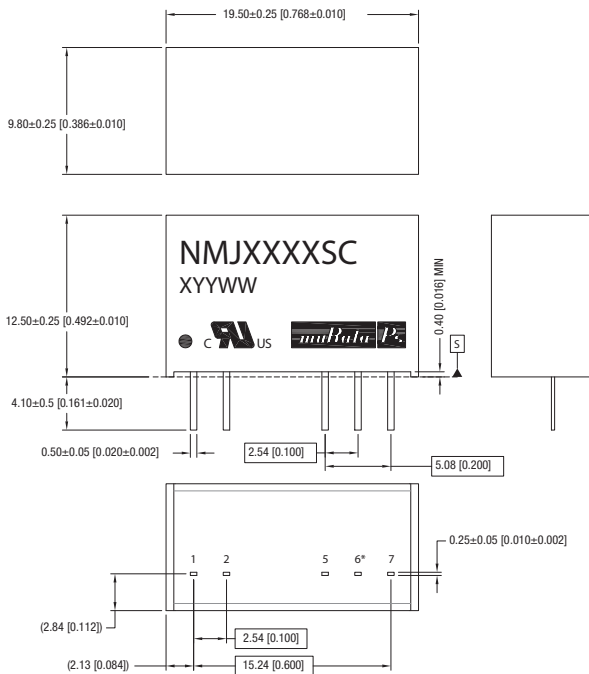

* Pin not fitted on single output variants. Weight: 4.3g
 All dimensions in mm (inches) Controlling dimension is mm.
 All pins on a 2.54 (0.100) pitch and within ±0.1 (0.004) of true position from pin 1 at seating plane 'S'

PIN CONNECTIONS

Dual Output

| Pin | Function |
|-----|----------|
| 1 | +VIN |
| 2 | -VIN |
| 5 | -VOUT |
| 6 | OV |
| 7 | +VOUT |

Single Output

| Pin | Function |
|-----|----------|
| 1 | +VIN |
| 2 | -VIN |
| 5 | -VOUT |
| 7 | +VOUT |

TUBE OUTLINE DIMENSIONS

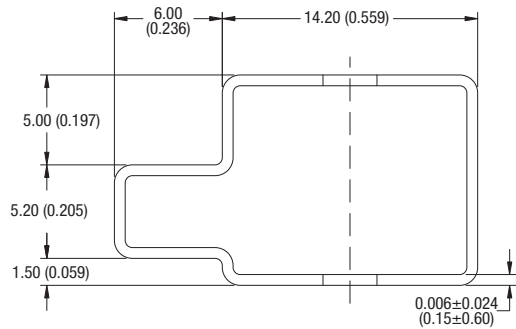

Unless otherwise stated all dimensions in mm ±0.5mm (inches ±0.02).
 Tube length : 525mm±2mm (20.669±0.079).

Tube Quantity : 25

RECOMMENDED FOOTPRINT DETAILS

Single Output Package:

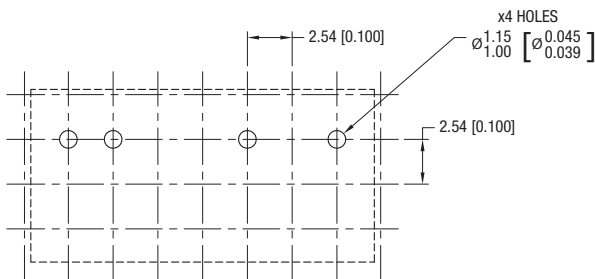

All dimensions in mm (inches) Controlling dimension is mm.

Dual Output Package:

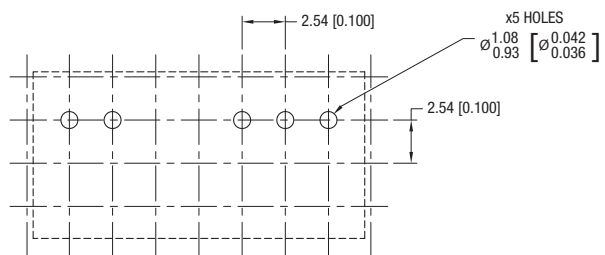

Murata Power Solutions, Inc.
 11 Cabot Boulevard, Mansfield, MA 02048-1151 U.S.A.
 ISO 9001 and 14001 REGISTERED



This product is subject to the following **operating requirements** and the **Life and Safety Critical Application Sales Policy**:
 Refer to: <http://www.murata-ps.com/requirements/>

Murata Power Solutions, Inc. makes no representation that the use of its products in the circuits described herein, or the use of other technical information contained herein, will not infringe upon existing or future patent rights. The descriptions contained herein do not imply the granting of licenses to make, use, or sell equipment constructed in accordance therewith. Specifications are subject to change without notice. © 2017 Murata Power Solutions, Inc.