

Ultra Small, Low-Input Voltage, Low R_{ON} Load Switch

Features

- Integrated Load Switch
- Input Voltage: 0.75-V to 3.6-V
- Intergrated Pass-FET $r_{DS(ON)}=2m\Omega$ (typ) at 3.6-V
- Ultra-Low ON Resistance
 - $r_{ON} = 5.3m\Omega$ at $V_{IN} = 3.6V$
 - $r_{ON} = 5.4m\Omega$ at $V_{IN} = 2.5V$
 - $r_{ON} = 5.5m\Omega$ at $V_{IN} = 1.8V$
 - $r_{ON} = 5.8m\Omega$ at $V_{IN} = 1.2V$
 - $r_{ON} = 6.1m\Omega$ at $V_{IN} = 1.05V$
 - $r_{ON} = 7.3m\Omega$ at $V_{IN} = 0.75V$
- Ultra Small CSP-8 package
 - 0.9 mm x 1.9 mm, 0.5-mm Pitch
- 4-A Maximum Continuous Switch Current
- Shutdown Current 5.5- μ A max
- Low Threshold Control Input
- Controlled Slew Rate to Avoid Inrush Currents
- Quick Output Discharge Transistor
- ESD Performance Tested Per JESD 22
 - 8000-V Human-Body Model (A114-B, Class II)
 - 1000-V Charged-Device Model (C101)

Applications

- Notebook / Netbook Computer
- Tablet PC
- PDAs / Smartphones
- GPS Navigation Devices
- MP3 Players

Description

The PI3PD22920 is a small, ultra-low r_{ON} load switch with controlled turn on. The device contains a N-channel MOSFET that can operate over an input voltage range of 0.75 V to 3.6 V and switch currents up to 4-A. An integrated charge pump biases the NMOS switch in order to achieve a minimum switch ON resistance (r_{ON}). The switch is controlled by an on/off input (ON), which is capable of interfacing directly with low-voltage control signals.

The PI3PD22920 has a 1250 Ω on-chip load resistor for quick output discharge when the switch is turned off.

The PI3D22920 has an internally controlled rise time in order to reduce inrush current. The PI3D22920 features a rise time of 880 μ S at 3.6V.

The PI3D22920 is available in an ultra-small, space-saving 8-pin CSP package and is characterized for operation over the free-air temperature range of -40°C to 85°C.

Pin Configuration (Bottom View)

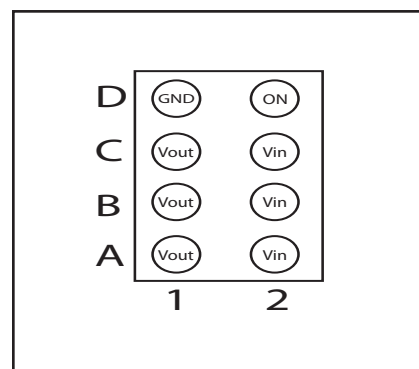

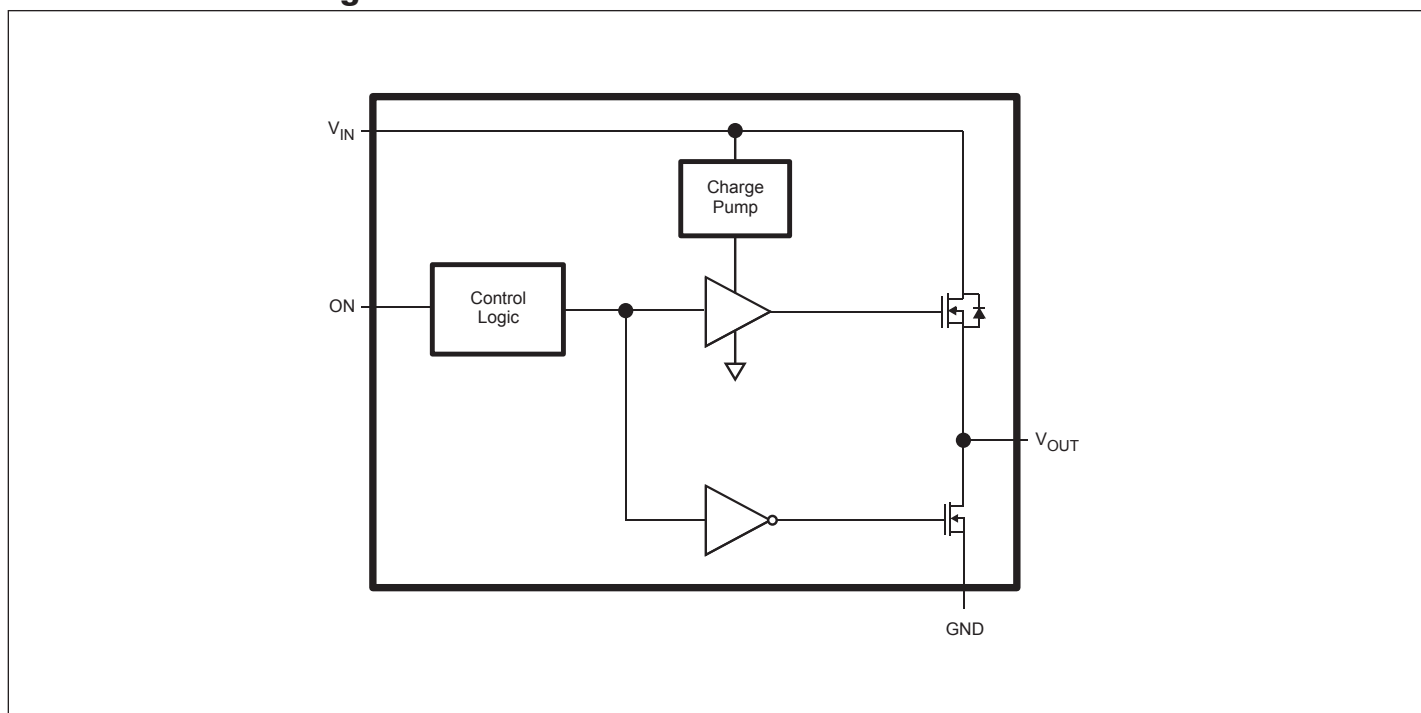
Functional Block Diagram

Function Table

ON (Control Input)	V_{IN} to V_{OUT}	V_{OUT} to GND
L	OFF	ON
H	ON	OFF

Pin Description

Terminal		Description
Ball No.	Name	
D1	GND	Ground
D2	ON	Switch Control Input. Active high, do not leave floating.
A1, B1, C1	V_{OUT}	Switch Output
A2, B2, C2	V_{IN}	Switch Input. Bypass this input with a ceramic capacitor to ground.

Absolute Maximum Ratings

V_{IN} , Input voltage range.....	-0.3V to 4V
V_{OUT} , Output voltage range.....	$V_{IN}+0.3V$
V_{ON} , Input voltage range.....	-0.3V to 4V
I_{MAX} , Maximum continuous switch current.....	4A
I_{PLS} , Maximum pulsed current (300- μ s pulse, 2% duty cycle).....	6A
T_A , Operating free-air temperature range	-40 °C to 85 °C
T_J , Maximum junction temperature.....	125 °C
T_{STG} , Storage temperature range.....	-65 °C to 150 °C
T_{LEAD} , Maximum lead temperature(10-s soldering time).....	300 °C
ESD, Electrostatic discharge protection , Charged Device Model(CDM).....	1000V
Human-Body Model(HBM).....	8000V

Note:

Stresses beyond those listed under absolute maximum ratings may cause permanent damage to the device. These are stress ratings only, and functional operation of the device at these or any other conditions beyond those indicated under Recommended Operating Conditions is not implied. Exposure to absolute-maximum-rated conditions for extended periods may affect device reliability.

Recommended Operating Conditions

Symbol	Parameter	Min.	Max.	Unit	
V_{IN}	Input voltage range	0.75	3.6	V	
V_{OUT}	Output voltage range		V_{IN}	V	
V_{IH}	High-level input voltage range, ON	$V_{IN} = 2.5 V$ to 3.6 V	1.2	3.6	V
		$V_{IN} = 0.75 V$ to 2.5 V	0.9	3.6	V
V_{IL}	Low-level input voltage range, ON	$V_{IN} = 2.5 V$ to 3.6 V		0.6	V
		$V_{IN} = 0.75 V$ to 2.49 V		0.4	V
C_{IN}	Input capacitor	1		μ F	

DC Electrical Characteristics Unless otherwise specified, $V_{IN} = 0.75V$ to $3.6V$

Parameter	Conditions	T_A^1	Min.	Typ.	Max.	Unit	
Power Switch							
I_{IN}	Quiescent current	$I_{OUT} = 0, V_{IN} = V_{ON}$	Full		37	47	μA
					23	30	
					14	25	
					9	11	
					4	11	
					2	5	
$I_{IN(LEAKAGE)}$	OFF-state supply current	$V_{ON} = GND, V_{OUT} = 0$	Full		5.5	μA	
R_{ON}	ON-state resistance	$I_{OUT} = -200\text{ mA}$	25°C	Full	5.3	8.8	$m\Omega$
					9.8		
			25°C	Full	5.4	8.9	
					9.9		
			25°C	Full	5.5	9.1	
					10.1		
			25°C	Full	5.8	9.4	
					10.4		
			25°C	Full	6.1	9.7	
					10.8		
			25°C	Full	7.3	11.0	
					12.4		
r_{PD}	Output pulldown resistance ²	$V_{IN} = 3.3\text{ V}, V_{ON} = 0, I_{OUT} = 3\text{ mA}$	Full		1250	1500	Ω
I_{ON}	ON input leakage current	$V_{ON} = 0.75V$ to 3.6 V or GND	Full		0.1	μA	

Note:

1. Typical values are at $V_{IN} = 3.3\text{ V}$ and $T_A = 25^\circ C$.
2. See Output Pulldown in Application Information.

Switching Characteristics

Symbol	Parameter	Conditions			Min.	Typ.	Max.	Units
$V_{IN} = 3.6V, T_A = 25^\circ C$ (Unless otherwise specified)								
t_{ON}	Turn-ON time	$R_L = 10\Omega$	$C_L = 0.1\mu F$	$V_{IN} = 3.6V$		970		μs
t_{OFF}	Turn-OFF time					3		μs
t_r	V_{OUT} rise time					880		μs
t_f	V_{OUT} fall time					2		μs
$V_{IN} = 0.9V, T_A = 25^\circ C$ (Unless otherwise specified)								
t_{ON}	Turn-ON time	$R_L = 10\Omega$	$C_L = 0.1\mu F$	$V_{IN} = 0.9V$		840		μs
t_{OFF}	Turn-OFF time					16		μs
t_r	V_{OUT} rise time					470		μs
t_f	V_{OUT} fall time					5		μs

Parameter Measurement Information

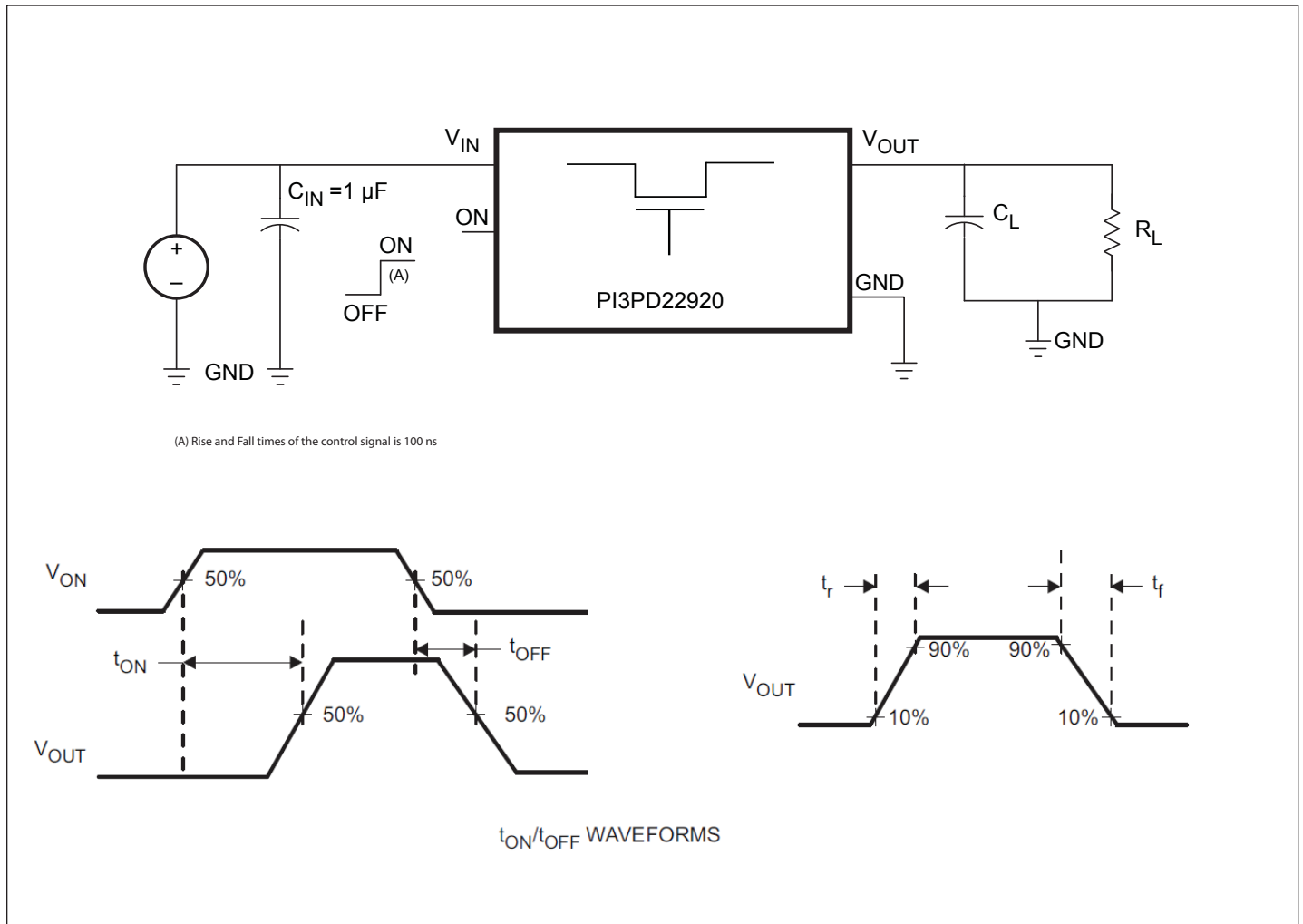

Figure 1. Test Circuit and t_{ON}/t_{OFF} Waveforms

ON-STATE RESISTANCE vs INPUT VOLTAGE

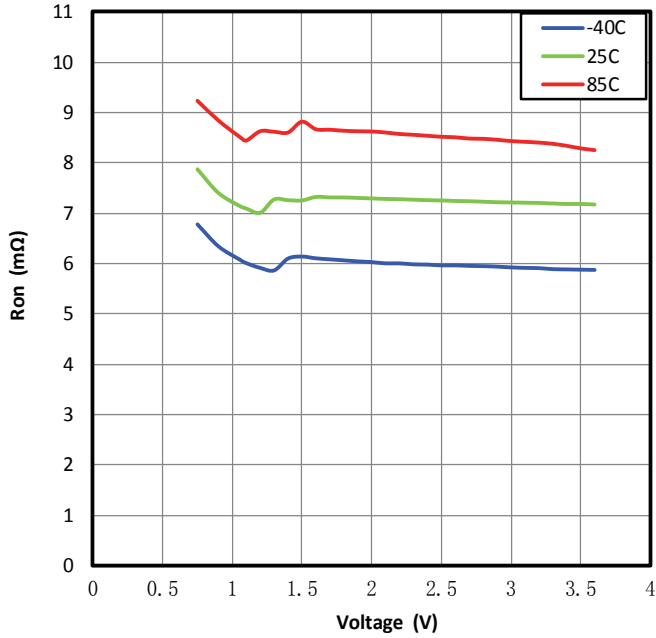

Figure 2.

ON-STATE RESISTANCE vs TEMPERATURE

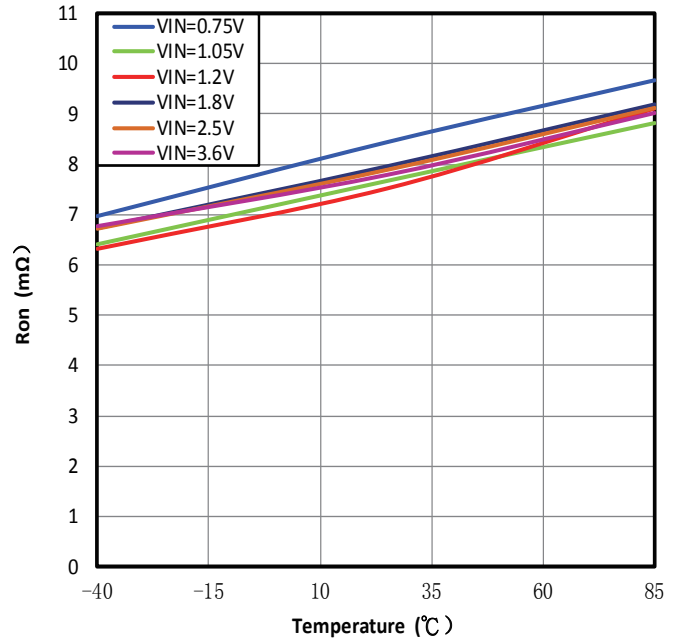

Figure 3.

INPUT CURRENT, QUIESCENT vs INPUT VOLTAGE

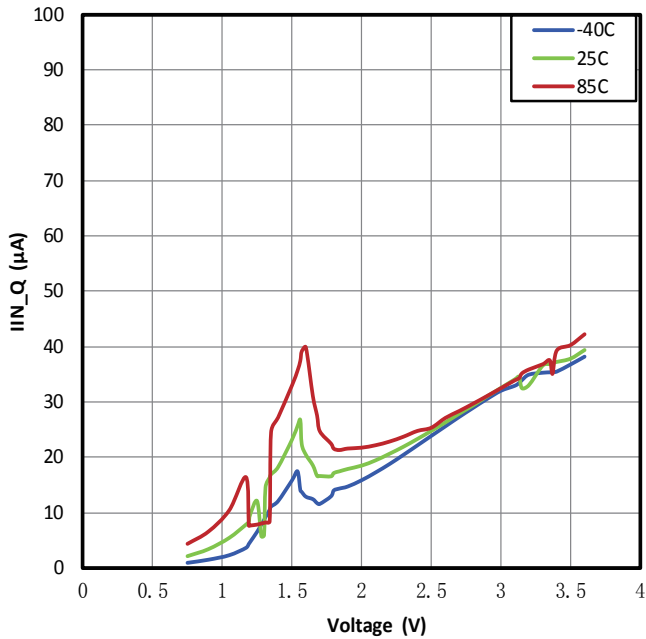

Figure 4.

INPUT CURRENT, LEAK vs INPUT VOLTAGE

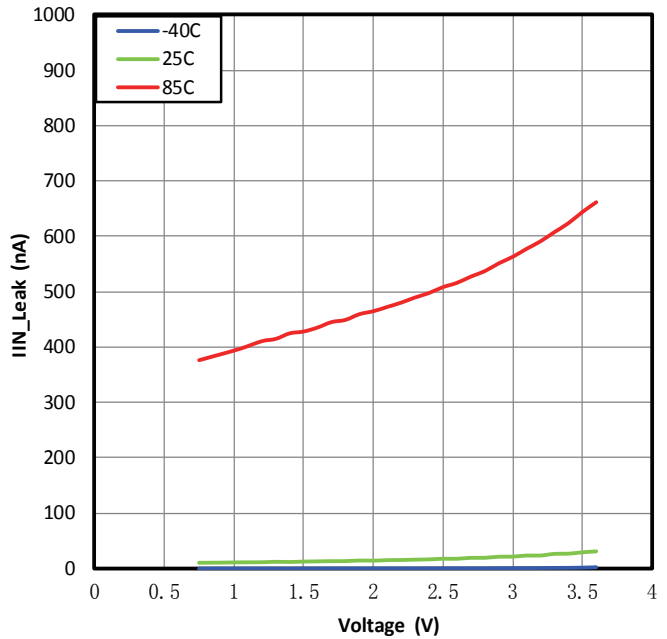

Figure 5.

ON INPUT THRESHOLD

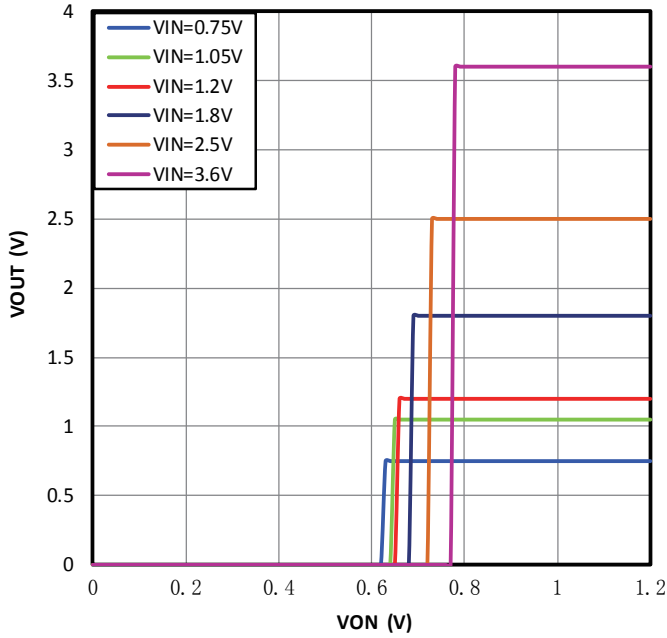

Figure 6.

TURN-ON TIME vs TEMPERATURE

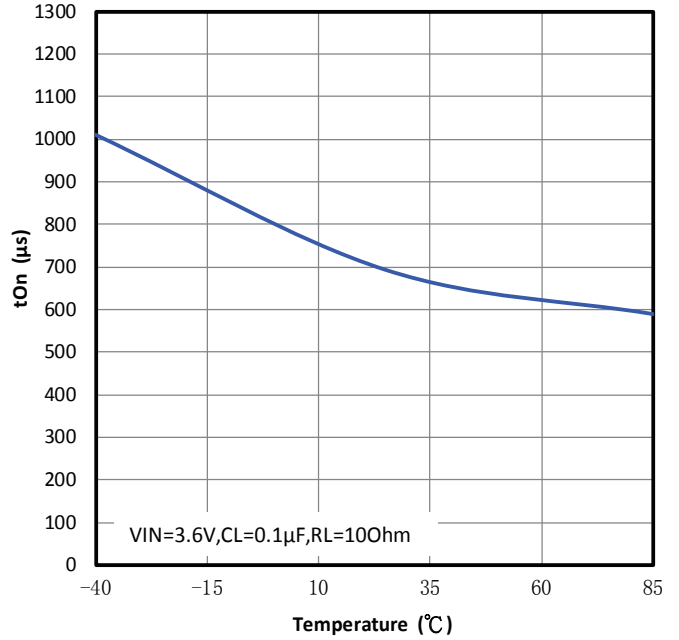

Figure 7.

TURN-OFF TIME vs TEMPERATURE

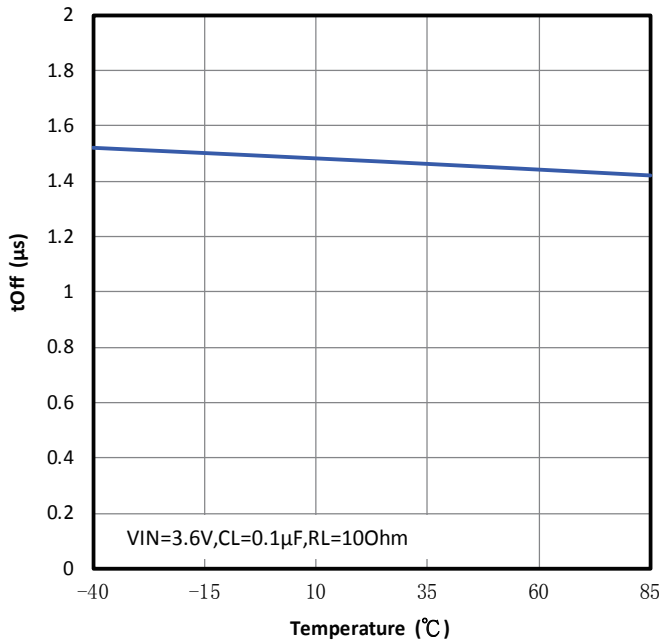

Figure 8.

RISE TIME vs TEMPERATURE

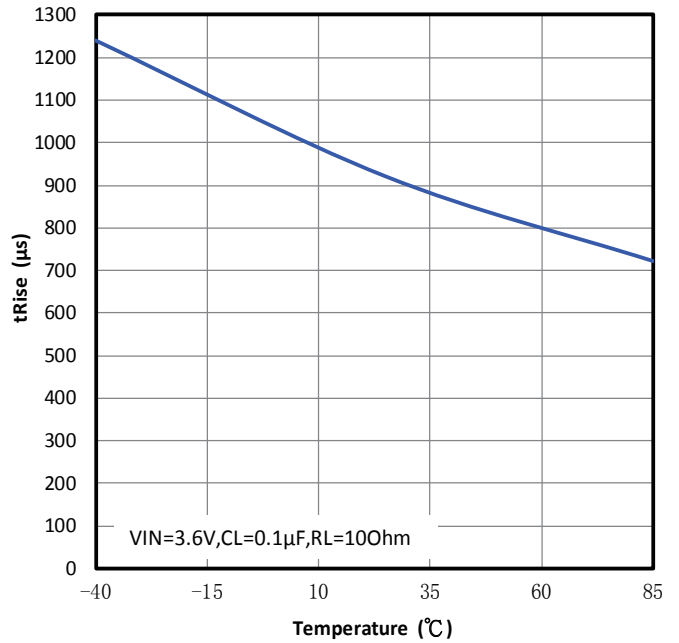

Figure 9.

FALL TIME vs TEMPERATURE

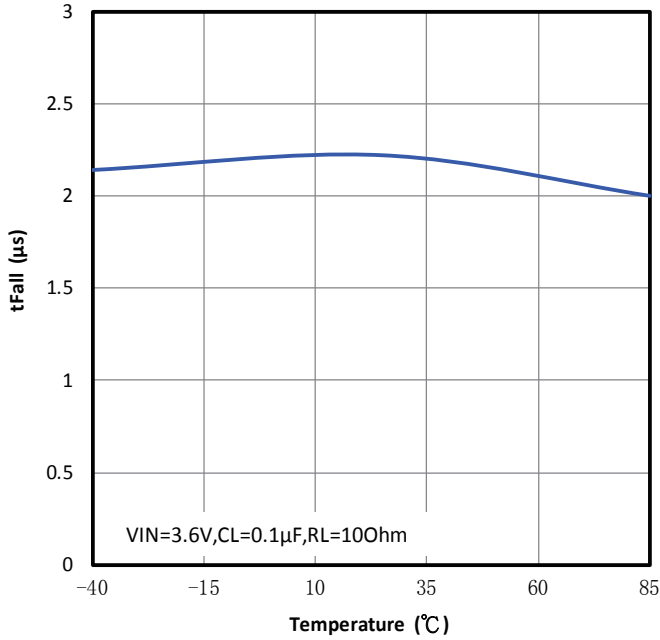

Figure 10.

TURN-ON TIME vs TEMPERATURE

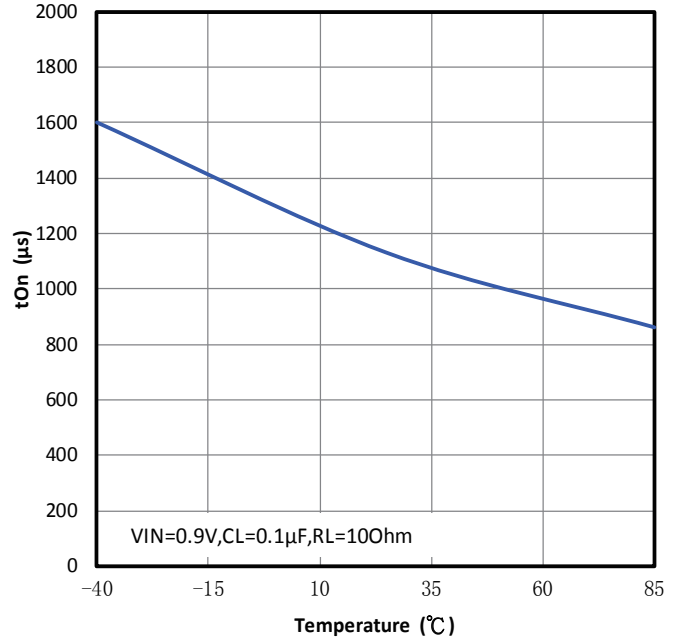

Figure 11.

TURN-OFF TIME vs TEMPERATURE

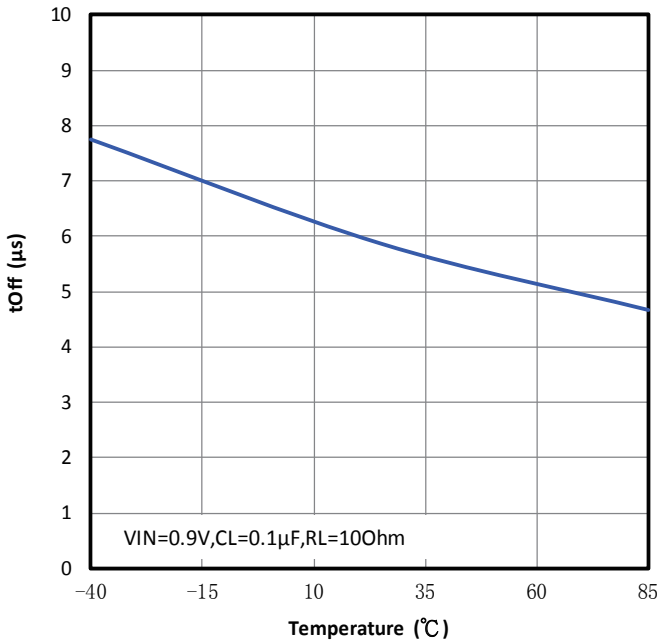

Figure 12.

RISE TIME vs TEMPERATURE

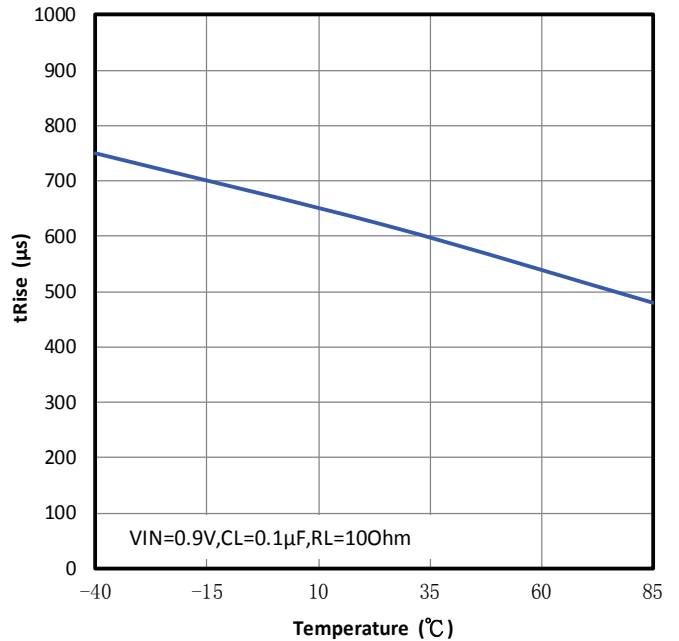

Figure 13.

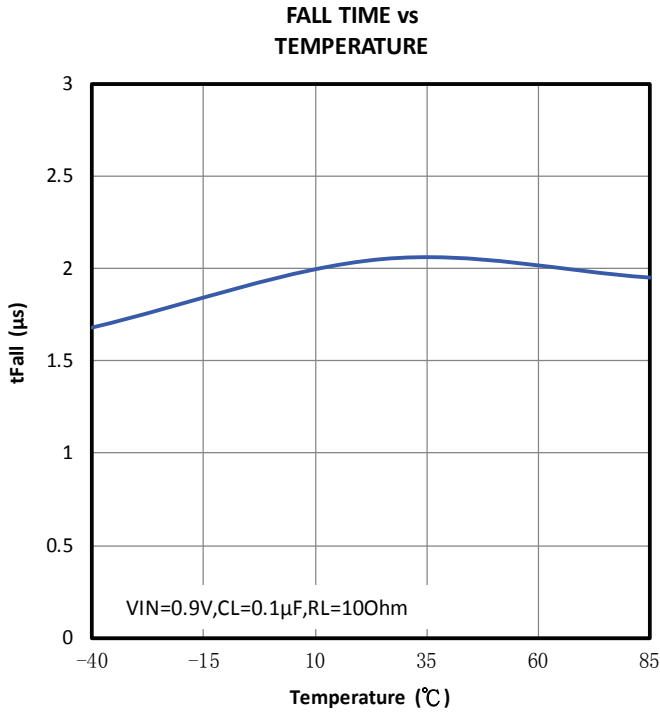

Figure 14.

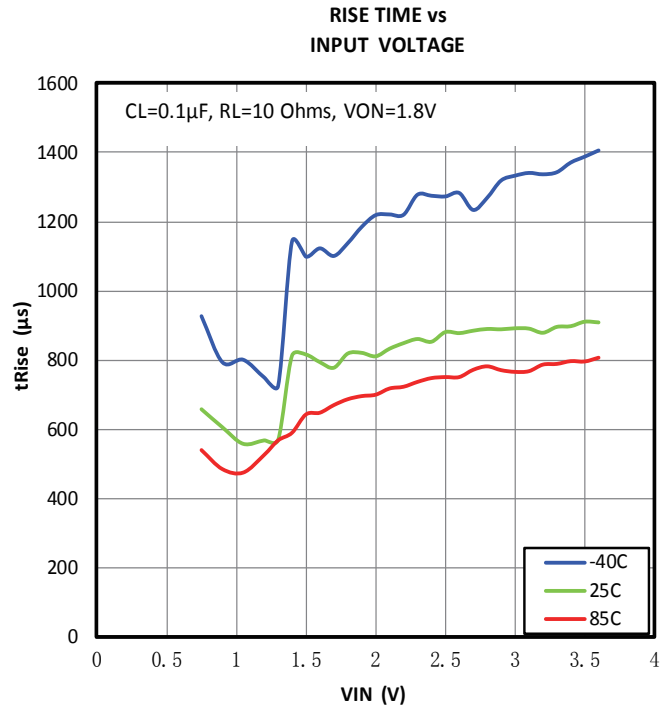

Figure 15.

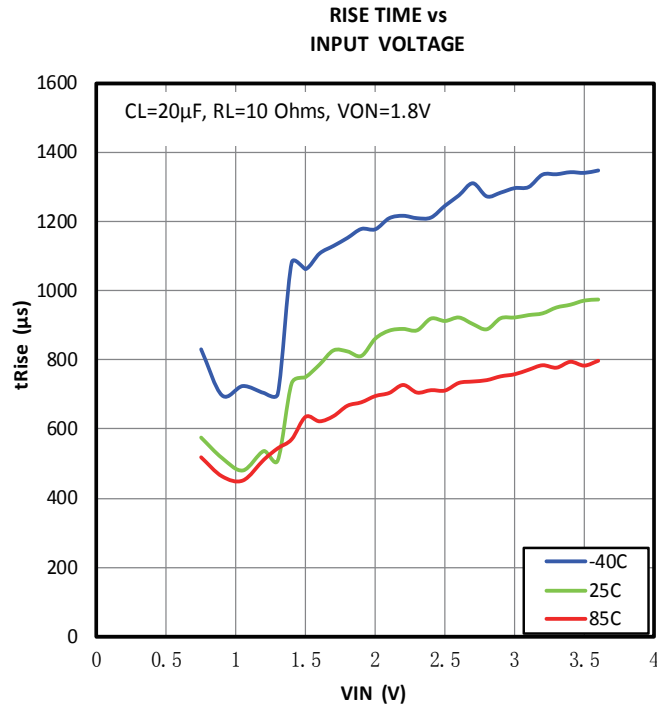

Figure 16.

TURN-ON RESPONSE

$V_{in}=0.9V, T_A=25C, C_{IN}=1\mu F, C_L=0.1\mu F, R_L=10\Omega$

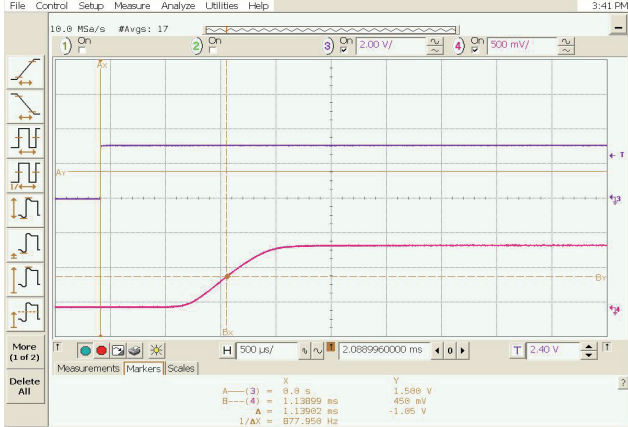

Figure 17.

TURN-OFF RESPONSE

$V_{in}=0.9V, T_A=25C, C_{IN}=1\mu F, C_L=0.1\mu F, R_L=10\Omega$



Figure 18.

TURN-ON RESPONSE

$V_{in}=0.9V, T_A=25C, C_{IN}=47\mu F, C_L=20\mu F, R_L=10\Omega$

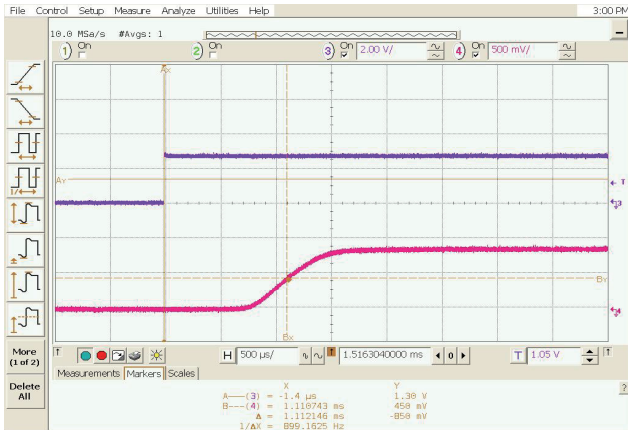

Figure 19.

TURN-OFF RESPONSE

$V_{in}=0.9V, T_A=25C, C_{IN}=47\mu F, C_L=20\mu F, R_L=10\Omega$

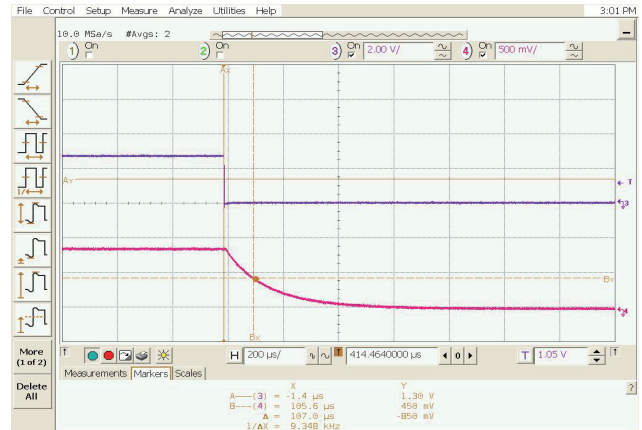

Figure 20.

TURN-ON RESPONSE

$V_{in}=3.6V, T_A=25C, C_{IN}=1\mu F, C_L=0.1\mu F, R_L=10\Omega$

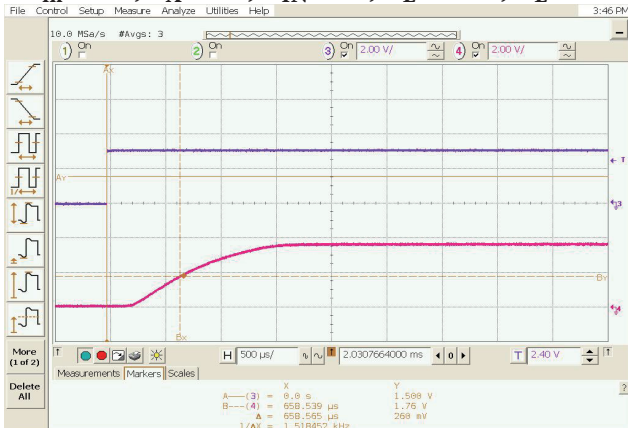

Figure 21.

TURN-OFF RESPONSE

$V_{in}=3.6V, T_A=25C, C_{IN}=1\mu F, C_L=0.1\mu F, R_L=10\Omega$

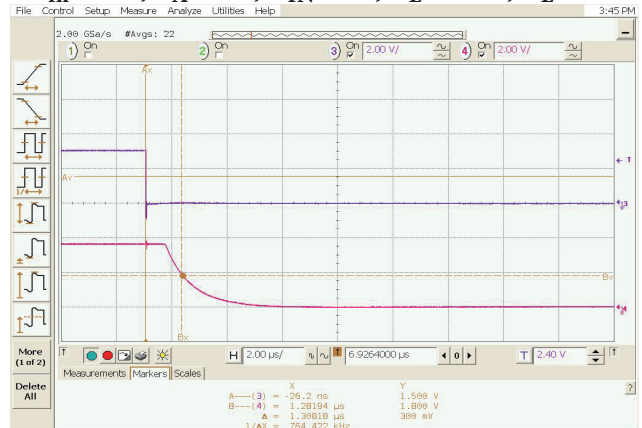

Figure 22.

TURN-ON RESPONSE

$V_{in}=3.6V, T_A=25C, C_{IN}=47\mu F, C_L=20\mu F, R_L=10\Omega$

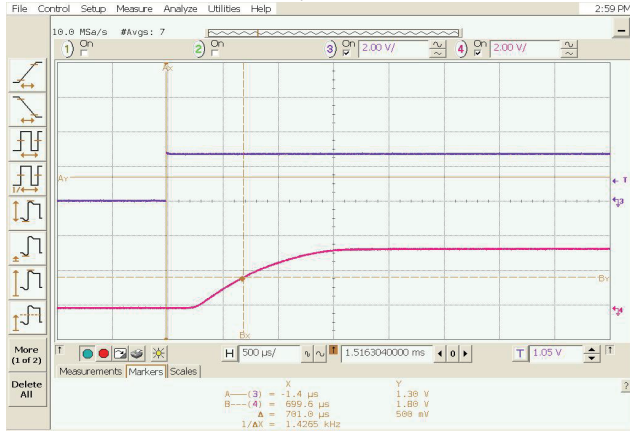

Figure 23.

TURN-OFF RESPONSE

$V_{in}=3.6V, T_A=25C, C_{IN}=47\mu F, C_L=20\mu F, R_L=10\Omega$

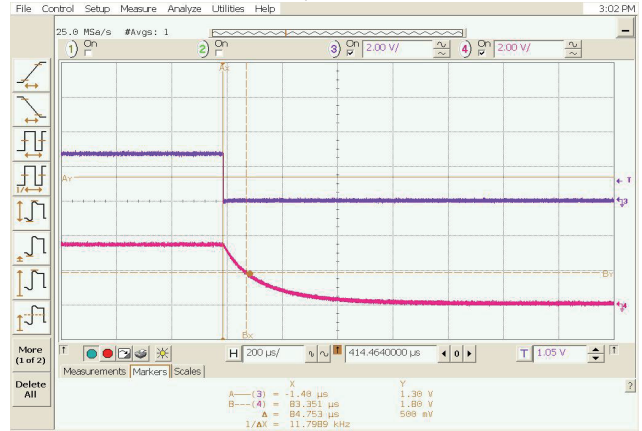
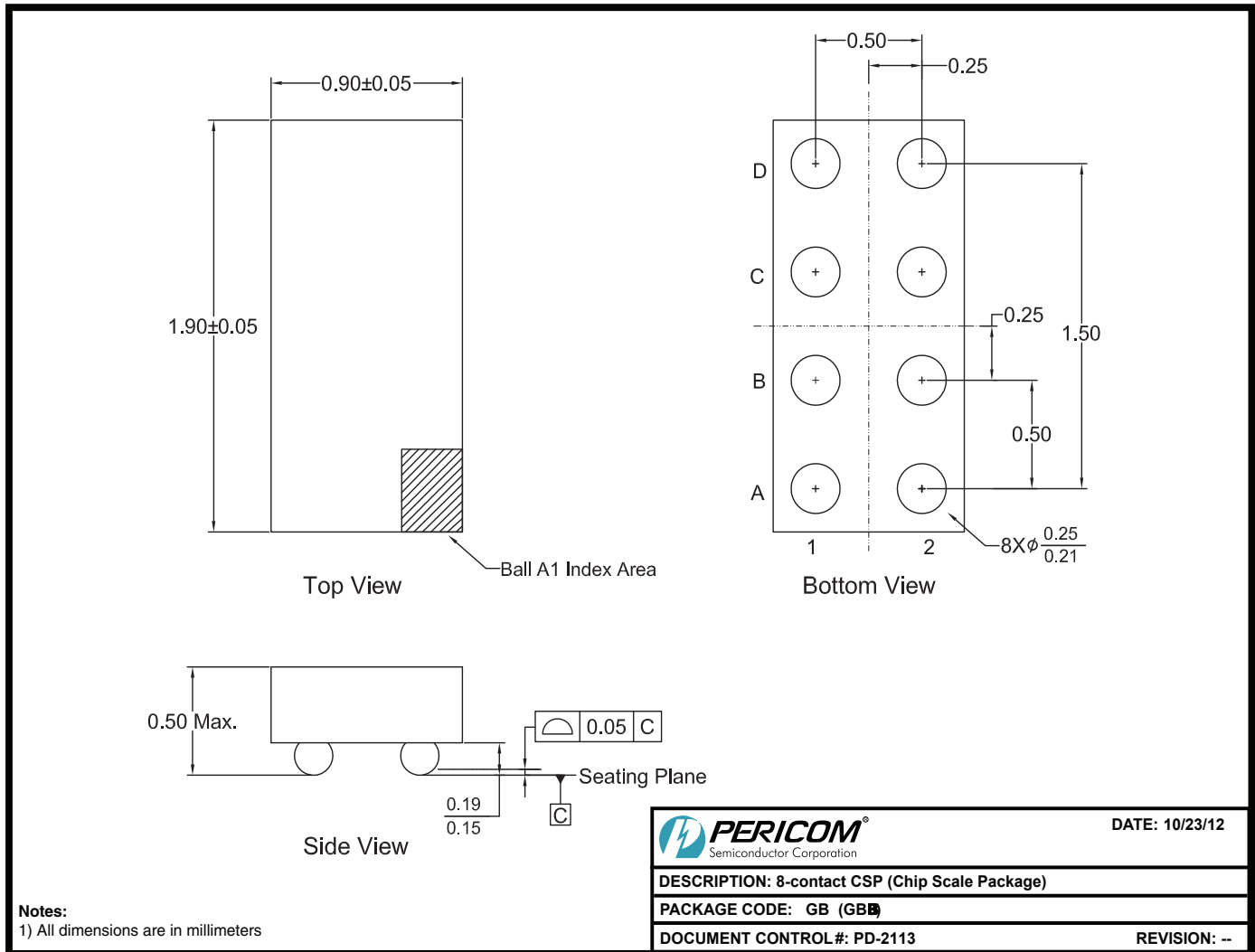

Figure 24.

Packaging Mechanicals: 8-contact CSP (GB)

Ordering Information⁽¹⁻³⁾

Ordering Code	Package Code	Package Description
PI3PD22920GBE	GB	8-contact Chip Scale Package (CSP), Pb-free & Green

Notes:

1. Thermal characteristics can be found on the company web site at www.pericom.com/packaging/
2. E = Pb-free and Green
3. Adding an X suffix = Tape/Reel