

## Low-Power 2.25V to 3.63V DC to 150MHz 1:4 Fanout Buffer IC

### FEATURES

- 1:4 LVCMOS output fanout buffer for DC to 150MHz
- Low Additive Phase Jitter of 60fs RMS
- 8mA Output Drive Strength
- Low power consumption for portable applications
- Low input-output delay
- Output-Output skew less than 250ps
- 2.5V to 3.3V,  $\pm 10\%$  operation
- Operating temperature range from  $-40^{\circ}\text{C}$  to  $85^{\circ}\text{C}$
- Available in 8-Pin SOP GREEN/RoHS package

### DESCRIPTION

The PL133-47 is an advanced fanout buffer design for high performance, low-power, small form factor applications. The PL133-47 accepts a reference clock input from DC to 150MHz and provides 4 outputs of the same frequency.

The PL133-47 is offered in a SOP-8L package and it offers the best phase noise, additive jitter performance, and lowest power consumption of any comparable IC.

### BLOCK DIAGRAM AND PACKAGE PINOUT

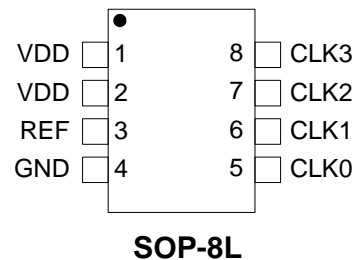
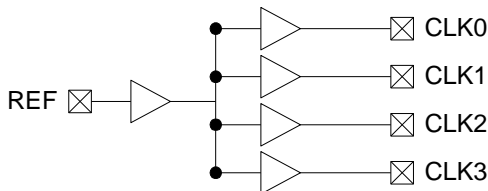

**Low-Power 2.25V to 3.63V DC to 150MHz 1:4 Fanout Buffer IC**
**PIN DESCRIPTIONS**

Name	SOP-8L	Type	Description
REF	3	I	Input reference frequency.
CLK0	5	O	Buffered clock output
CLK1	6	O	Buffered clock output
CLK2	7	O	Buffered clock output
CLK3	8	O	Buffered clock output
VDD	1, 2	P	VDD connection
GND	4	P	GND connection

**LAYOUT RECOMMENDATIONS**

The following guidelines are to assist you with a performance optimized PCB design:

**Signal Integrity and Termination Considerations**

- Keep traces short!
- Trace = Inductor. With a capacitive load this equals ringing!
- Long trace = Transmission Line. Without proper termination this will cause reflections ( looks like ringing ).
- Design long traces (> 1 inch) as "striplines" or "microstrips" with defined impedance.
- Match trace at one side to avoid reflections bouncing back and forth.

**Decoupling and Power Supply Considerations**

- Place decoupling capacitors as close as possible to the VDD pin(s) to limit noise from the power supply
- Addition of a ferrite bead in series with VDD can help prevent noise from other board sources
- Value of decoupling capacitor is frequency dependant. Typical values to use are 0.1 $\mu$ F for designs using frequencies < 50MHz and 0.01 $\mu$ F for designs using frequencies > 50MHz.

**Typical CMOS termination**

Place Series Resistor as close as possible to CMOS output

CMOS Output Buffer  
( Typical buffer impedance 20 ohm)

To CMOS Input

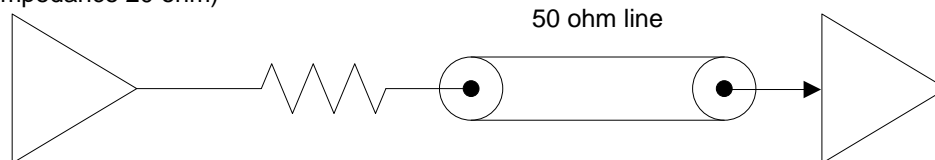

Connect a 33 ohm series resistor at each of the output clocks to enhance the stability of the output signal

**Low-Power 2.25V to 3.63V DC to 150MHz 1:4 Fanout Buffer IC**
**ABSOLUTE MAXIMUM CONDITIONS**

Supply Voltage to Ground Potential ..... -0.5V to 4.6V  
 DC Input Voltage .....  $V_{SS} - 0.5V$  to 4.6V  
 Storage Temperature ..... -65°C to 150°C

Junction Temperature..... 150°C  
 Static Discharge Voltage  
 (per MIL-STD-883, Method 3015)..... > 2000V

**OPERATING CONDITIONS**

Parameter	Description	Min.	Max.	Unit
$V_{DD}$	Supply Voltage	2.25	3.63	V
$T_A$	Commercial Operating Temperature (ambient temperature)	0	70	°C
	Industrial Operating Temperature (ambient temperature)	-40	85	°C
$C_L$	Load Capacitance, below 100 MHz	—	30	pF
	Load Capacitance between 100 MHz and 134 MHz	—	10	pF
	Load Capacitance, above 134 MHz	—	5	pF
$C_{IN}$	Input Capacitance	—	7	pF
REF, CLK[1:6]	Operating Frequency, Input=Output	DC	150	MHz
$t_{PU}$	Power-up time for all $V_{DD}$ s to reach minimum specified voltage (power ramps must be monotonic)	0.05	50	ms

**ELECTRICAL CHARACTERISTICS (Commercial and Industrial Temperature Devices)**

Parameter	Description	Test Conditions	Min.	Max.	Unit
$V_{IL}$	Input LOW Voltage <sup>[1]</sup>		—	0.8	V
$V_{IH}$	Input HIGH Voltage <sup>[1]</sup>		2.0	—	V
$I_{IL}$	Input LOW Current	$V_{IN} = 0V$	—	50	μA
$I_{IH}$	Input HIGH Current	$V_{IN} = V_{DD}$	—	100	μA
$V_{OL}$	Output LOW Voltage <sup>[2]</sup>	$I_{OL} = 8\text{ mA}$	—	0.4	V
$V_{OH}$	Output HIGH Voltage <sup>[2]</sup>	$I_{OH} = -8\text{ mA}$	2.4	—	V
$I_{DD}$	Supply Current	66.67MHz with unloaded outputs	—	32	mA

## Low-Power 2.25V to 3.63V DC to 150MHz 1:4 Fanout Buffer IC

### SWITCHING CHARACTERISTICS (Commercial and Industrial Temperature Devices) <sup>[3]</sup>

Parameter	Description	Test Conditions	Min.	Typ.	Max.	Unit
	Duty Cycle <sup>[2]</sup> = $t_2 \div t_1$	Measured at 1.4V, Input is 50%	40	50	60	%
$t_3$	Rise Time <sup>[2]</sup>	Measured between 0.8V and 2.0V	–	–	1.5	ns
$t_4$	Fall Time <sup>[2]</sup>	Measured between 0.8V and 2.0V	–	–	1.5	ns
$t_5$	Output to Output Skew <sup>[2]</sup>	All outputs equally loaded	–	–	250	ps
$t_6$	Propagation Delay, REF Rising Edge to CLKX Rising Edge <sup>[2]</sup>	Measured at $V_{DD}/2$	1	5	9.2	ns

#### Notes:

1. REF input has a threshold voltage of  $V_{DD}/2$
2. Parameter is guaranteed by design and characterization. Not 100% tested in production.
3. All parameters are specified with loaded outputs.

### NOISE CHARACTERISTICS (Commercial and Industrial Temperature Devices)

Parameter	Description	Test Conditions	Min.	Typ.	Max.	Unit
	Additive Phase Jitter	$V_{DD}=3.3V$ , Frequency=100MHz Offset=12KHz ~ 20MHz		60		fs

PL133-47 Additive Phase Jitter:  
V<sub>DD</sub>=3.3V, CLK=100MHz, Integration Range 12KHz to 20MHz: 0.059ps typical.

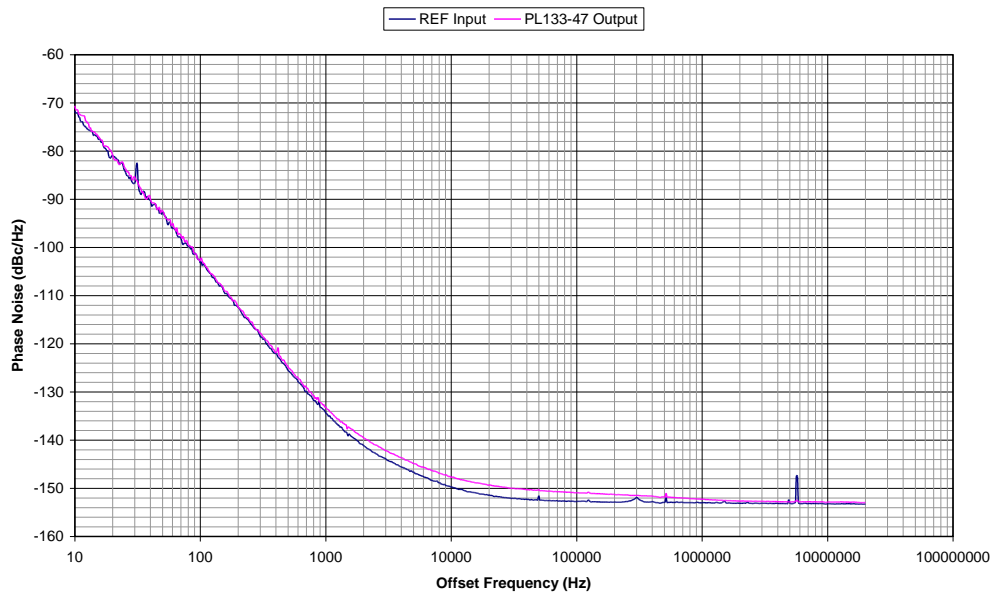

When a buffer is used to pass a signal then the buffer will add a little bit of its own noise. The phase noise on the output of the buffer will be a little bit more than the phase noise in the input signal. To quantify the noise addition in the buffer we compare the Phase Jitter numbers from the input and the output. The difference is called "Additive Phase Jitter". The formula for the Additive Phase Jitter is as follows:

$$\text{Additive Phase Jitter} = \sqrt{(\text{Output Phase Jitter})^2 - (\text{Input Phase Jitter})^2}$$

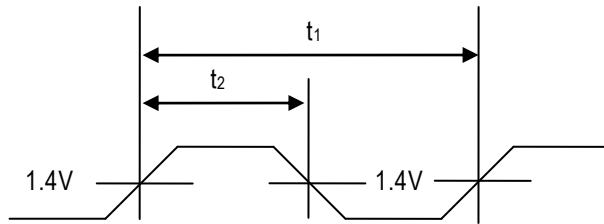
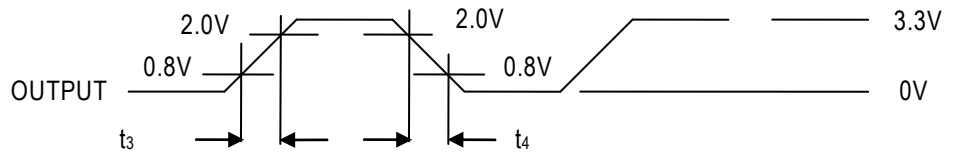
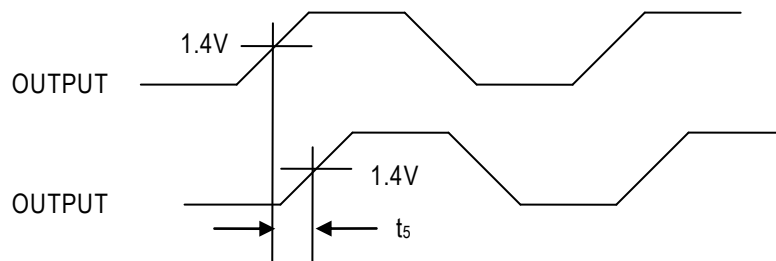
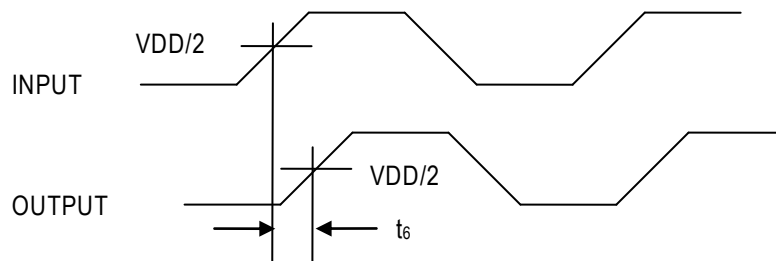
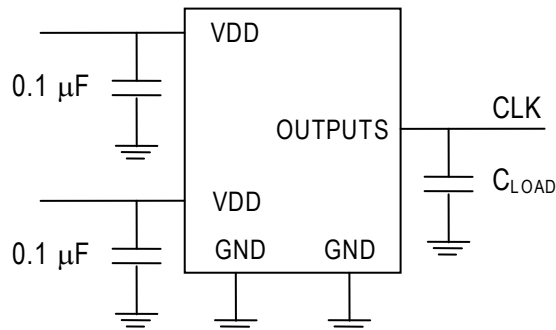
**Low-Power 2.25V to 3.63V DC to 150MHz 1:4 Fanout Buffer IC**
**SWITCHING WAVEFORMS**
**Duty Cycle Timing**

**All Outputs Rise/Fall Time**

**Output-Output Skew**

**Input-Output Propagation Delay**

**TEST CIRCUIT**

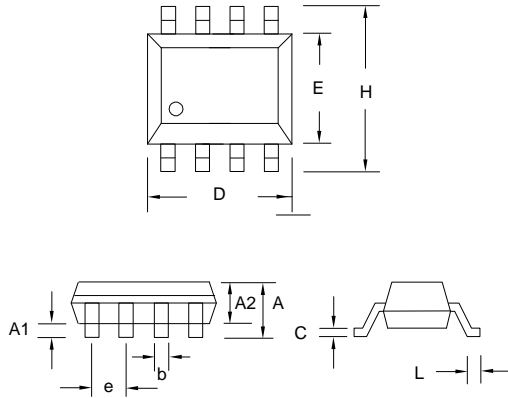
Low-Power 2.25V to 3.63V DC to 150MHz 1:4 Fanout Buffer IC

PACKAGE DRAWING (GREEN PACKAGE COMPLIANT)

SOP 8L

Symbol	Dimension in MM	
	Min.	Max.
A	1.35	1.75
A1	0.10	0.25
A2	1.25	1.50
B	0.33	0.53
C	0.19	0.27
D	4.80	5.00
E	3.80	4.00
H	5.80	6.20
L	0.40	0.89
e	1.27 BSC	



## Low-Power 2.25V to 3.63V DC to 150MHz 1:4 Fanout Buffer IC

### ORDERING INFORMATION

**For part ordering, please contact our Sales Department:**

2180 Fortune Drive, San Jose, CA 95131, USA

Tel: (408) 944-0800 Fax: (408) 474-1000

#### PART NUMBER

The order number for this device is a combination of the following:  
Part number, Package type and Operating temperature range

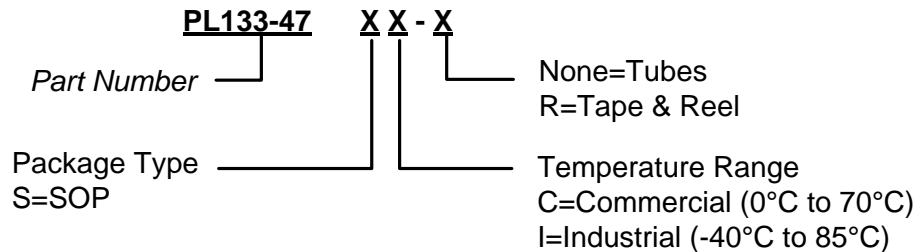

Part/Order Number	Marking	Package Option
Green (Lead-Free) Package		
PL133-47SC	P133-47 SC	8-Pin SOP Tube
PL133-47SC-R	LLLLL	8-Pin SOP (Tape and Reel)
PL133-47SI	P133-47 SI	8-Pin SOP Tube
PL133-47SI-R	LLLLL	8-Pin SOP (Tape and Reel)

\*Note: LLLLL designates lot number

Micrel Inc., reserves the right to make changes in its products or specifications, or both at any time without notice. The information furnished by Micrel is believed to be accurate and reliable. However, Micrel makes no guarantee or warranty concerning the accuracy of said information and shall not be responsible for any loss or damage of whatever nature resulting from the use of, or reliance upon this product.

**LIFE SUPPORT POLICY:** Micrel's products are not authorized for use as critical components in life support devices or systems without the express written approval of the President of Micrel Inc.