

INDUCTIVE PROXIMITY SENSORS

- SENSE FERROUS & NON-FERROUS METAL OBJECTS TO "ZERO SPEED"
- 2-WIRE CURRENT SOURCE & 3-WIRE NPN OPEN COLLECTOR & LOADED COLLECTOR TRANSISTOR OUTPUTS
- 3 SIZES & 3 SENSING DISTANCES FOR APPLICATION VERSATILITY
- L.E.D. TARGET INDICATOR (PSA 7A & 8A)

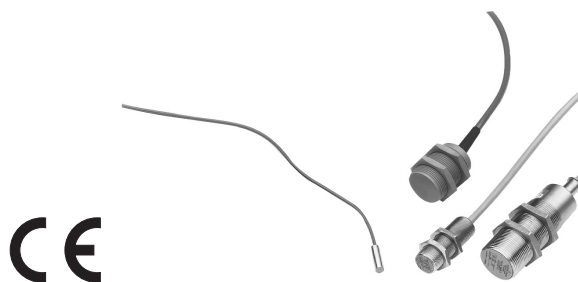

DESCRIPTION & OPERATION

Inductive Proximity Sensors detect the presence of metal objects which come within range of their oscillating field and provide target detection to "zero speed". Internally, an oscillator creates a high frequency electromagnetic field (RF) which is radiated from the coil and out from the sensor face (See Figure 1). When a metal object enters this field, eddy currents are induced into the object.

As the metal moves closer to the sensor, these eddy currents increase and result in an absorption of energy from the coil which dampens the oscillator amplitude until it finally stops.

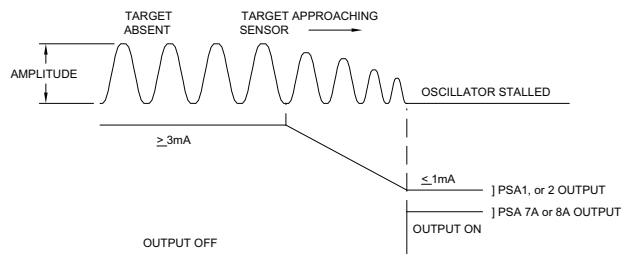
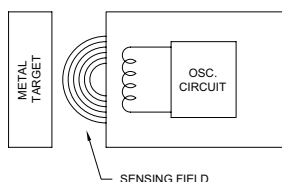

Figure 1

MODELS PSA-1 & 2

The 2-wire Models PSA-1 and 2 contain only the coil and oscillator circuit (See Figure 2). With no metal object being sensed, the circuit oscillates and draws greater than 3 mA of supply current. As a metal object of sufficient size is brought into the sensing field, the oscillator amplitude dampens and finally stops, resulting in less than 1mA of circuit current being drawn. This greater than 3 mA to less than 1 mA change in circuit current between oscillating and non-oscillating conditions is converted into a usable voltage signal (V_s) by placing a resistor (R_s) in series with the sensor leads.

PSA-1 & PSA-2 SPECIFICATIONS

| | PSA-1 | PSA-2 |
|---------------------------------|------------------------------------------------------------|--------------|
| 1. Power Supply: | +5 to +25 VDC | |
| 2. Maximum Switching Frequency: | 5 KHz | 300 Hz |
| 3. Output: | Less than 1 mA Target Sensed; Greater than 3 mA No Target. | |
| 4. Maximum Sensing Distance: | 0.06" (1.5 mm) | 0.4" (10 mm) |
| 5. Wire Color Code: | Black or Brown = +VDC; Blue = Count | |
| 6. Operating Temperature: | -25°C to +70°C (-14°F to +158°F) | |
| 7. Construction: | NEMA 1, 2, 3, 3R, 4, 4X, 5, 6, 6P, 12, and 13. | |

DIMENSIONS In inches (mm)

PSA-1

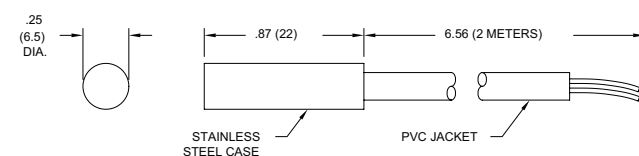

PSA-2

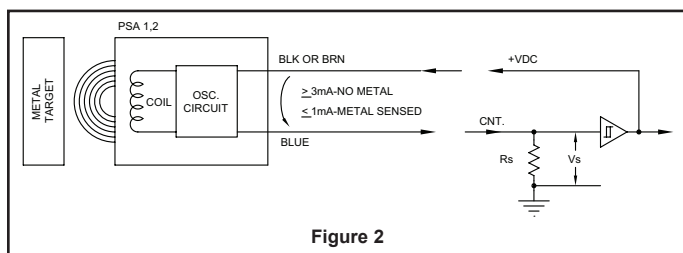
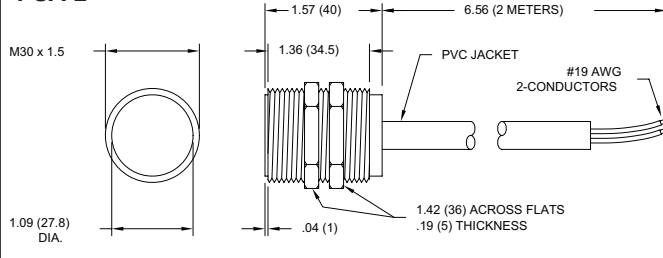

Figure 2

In addition to the coil and oscillator circuit, the 3-wire Models PSA-7A and 8A each contain a Detector Circuit and NPN Transistor Output (See Figure 3). In these units, the Detector Circuit senses when the oscillator stops, and turns on the Output Transistor which controls the load. The Detector Circuit also turns on an integrally case mounted L.E.D., visually indicating when a metal object is sensed.

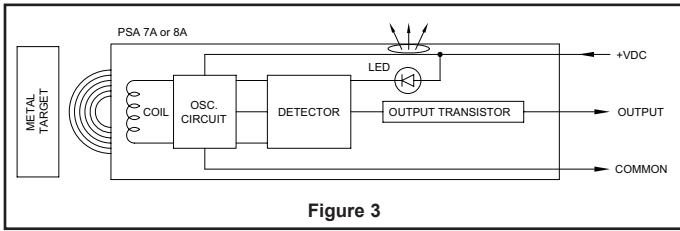

Figure 3

PSA-7A & 8A

These Inductive Proximity Sensors have a maximum sensing distance of 0.2" (5 mm) and 0.4" (10 mm) respectively, and operate over a wide power supply range (See Specifications Below). They are each housed in threaded stainless steel cases and are supplied with 2 stainless steel jam nuts for mounting. The NPN transistor outputs have an internal pull-up resistor and are compatible with most RLC counter and rate input circuits. Maximum sensing frequencies are 1 KHz and 100 Hz respectively. In addition, the outputs are overload and short circuit protected. These sensors are shielded for flush mounting in metal applications.

PSA-7A & 8A SPECIFICATIONS

| | PSA-7A | PSA-8A |
|---------------------------------|--------------------------------------------------------------------|--------------|
| 1. Power Supply: | +10 to 30 VDC @ 15 mA max. | |
| | REVERSE POLARITY PROTECTION | |
| 2. Maximum Switching Frequency: | 1 KHz | 100 Hz |
| 3. Output: | NPN Loaded Collector Transistor, Overload Short Circuit protected. | |
| | VSAT = 3 V @ 100 mA max. load | |
| 4. Maximum Sensing Distance: | 0.2" (5 mm) | 0.4" (10 mm) |
| 5. Wire Color Code: | Brown = +VDC; Blue = Common; Black = Output | |
| 6. Operating Temperature: | -25°C to +70°C (-14°F to +158°F) | |
| 7. Construction: | NEMA 1, 2, 3, 3R, 4, 4X, 5, 6, 6P, 12, and 13 | |

DIMENSIONS In inches (mm)

PSA-7A

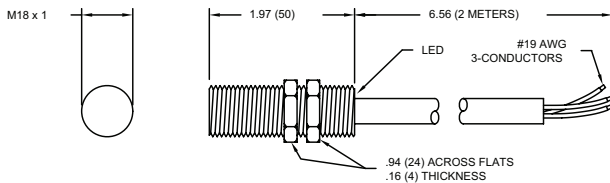

PSA-8A

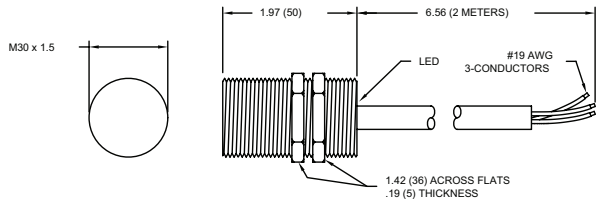

NOTES:

- PSA 7A & 8A case and jam nut material = brass nickel plated.
- Polyurethane Cable Jacket.

SELECTION & APPLICATION OF PROXIMITY SENSORS

Selection of the proper proximity sensor depends on the size, material, and spacing of the target being sensed and the sensing distance that can be maintained. The maximum sensing distance is defined as the distance in which the sensor is just close enough to detect a ferrous target whose diameter is equal to or greater than the sensor diameter. In actual application, the sensing distance should be between 50 to 80% of the maximum sensing range to assure reliable detection. For target sizes smaller than the sensor diameter, the maximum sensing distance can be estimated from the curve (See Figure 4). A further reduction factor must also be applied if the target material is non-ferrous metal (See Figure 5). Ideally, spacing between adjacent targets should be at least one sensor diameter so that the first target completely leaves the sensors field before the next target appears. Individual targets can still be resolved as separate objects if this spacing is reduced to 70 or 75% of the sensor diameter, however, this can introduce a minimum limit on sensing distance that makes adjustment more critical. All Proximity sensors are internally shielded which allows the sensor face to be flush mounted in metal applications without reducing sensing distance. In applications where proximity sensor's must be placed next to each other, a distance of at least 1 sensor diameter should separate sensors to eliminate any frequency interference (See Figure 6).

MAXIMUM SENSING DISTANCE REDUCTION FACTORS

Reduction in the max. sensing distance due to decrease in diameter of ferrous targets.

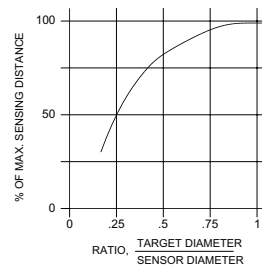

Figure 4

Typical reduction factors for various non-ferrous targets with diameters equal to or greater than sensor diameter.

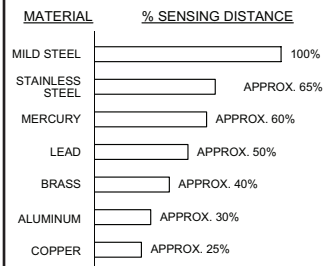

Figure 5

MINIMUM SENSOR SPACING

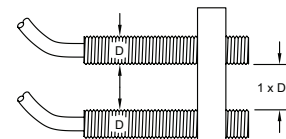
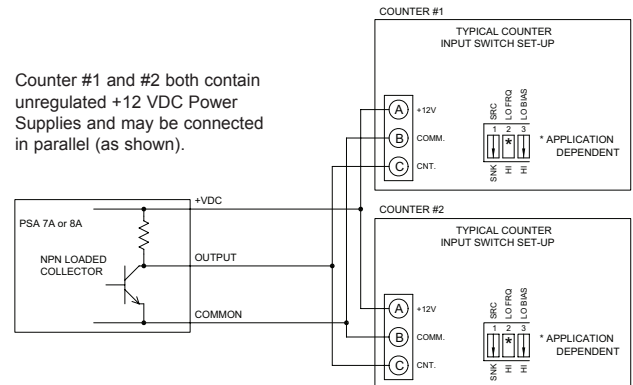
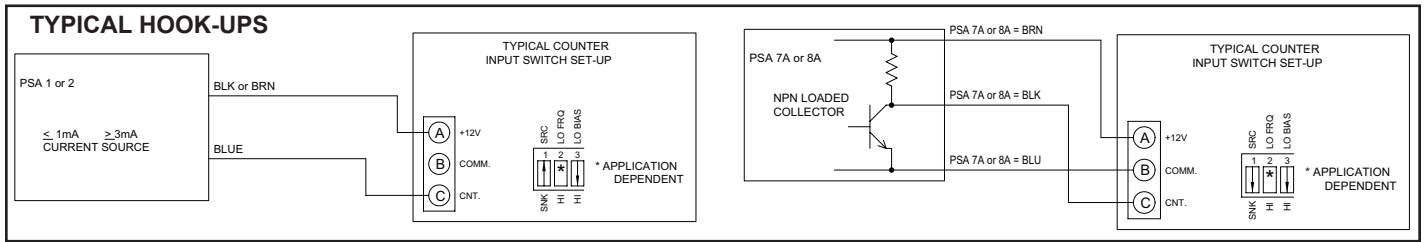

Figure 6

Note: PSA-7A, and 8A outputs are NPN loaded collector outputs which contain an internal load resistor that is returned to +VDC for internal feedback purposes. This does not interfere with the ability to use these sensors as conventional "Open Collector" outputs, as long as the +VDC for the proximity sensor is supplied by the indicator or control receiving its output signal. A PSA-7A, or 8A may be used as an input to more than 1 indicator or control only if the respective power supplies are "unregulated" and can load share. These supplies may then be paralleled together as shown. An indicator or control with a regulated power supply may not be paralleled.





APPLICATION SELECTION CHART

| | PSA-1 | PSA-2 | PSA-7A | PSA-8A |
|-------------------------|-------------------------|-------------------------|---------------------------------|---------------------------------|
| MAX. SENSING DISTANCE | 0.06" (1.5 mm) | 0.40" (10 mm) | 0.20" (5 mm) | 0.40" (10 mm) |
| MAX. SWITCHING FREQ. | 5 KHz | 300 Hz | 1 KHz | 100 Hz |
| POWER SUPPLY | 5-25 VDC | 5-25 VDC | 10-30 VDC | 10-30 VDC |
| OUTPUT | <math>< mA> 3 mA</math> | <math>< mA> 3 mA</math> | NPN Loaded Collector Transistor | NPN Loaded Collector Transistor |
| L.E.D. TARGET INDICATOR | No | No | Yes | Yes |

MODELS MB4 & 5 MOUNTING BRACKETS

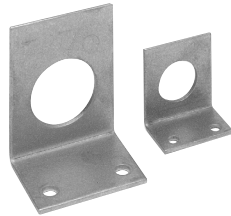

DIMENSIONS

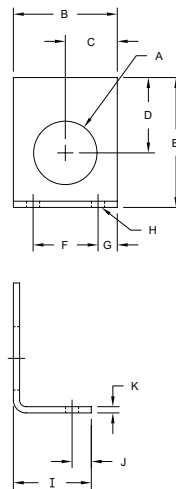

The Models MB4 and 5 are stainless steel right angle mounting brackets, designed to provide easy mounting and adjustment of PSA-7A and 8A respectively, using the 2 hex jam nuts provided with each sensor.

DIMENSIONS In inches (mm)

| BRACKET MODEL NO. | SENSOR MODEL | SENSOR HOLE DIAMETER A | B | C | D | E |
|-------------------|--------------|------------------------|---------------|---------------|--------------|--------------|
| MB4 | PSA-7A | 0.75" (19.1) | 1.38" (34.92) | 0.69" (17.5) | 0.78" (19.8) | 1.50" (38.1) |
| MB5 | PSA-8A | 1.22" (31) | 2.00" (50.80) | 1.00" (25.40) | 1.45" (36.9) | 2.50" (63.5) |

| BRACKET MODEL NO. | SENSOR MODEL | F | G | MOUNTING DIA. (2) PLACES H | I | J | K |
|-------------------|--------------|---------------|-------------|----------------------------|--------------|-------------|-------------|
| MB4 | PSA-7A | 0.875" (22.2) | 0.25" (6.3) | 0.19" (4.8) | 1.00" (25.4) | 0.22" (5.6) | 0.12" (3.2) |
| MB5 | PSA-8A | 1.25" (31.7) | 0.37" (9.5) | 0.25" (6.3) | 1.50" (38.1) | 0.37" (9.5) | 0.12" (3.2) |

ORDERING INFORMATION

| MODEL NO. | DESCRIPTION | PART NUMBER |
|-----------|-----------------------------------------|-------------|
| PSA1 | 2-Wire Cylindrical Proximity Sensor | PSA10000 |
| PSA2 | 2-Wire, 30 mm Threaded Proximity Sensor | PSA20000 |
| PSA7A | 18mm Threaded Proximity Sensor | PSA7A000 |
| PSA8A | 30mm Threaded Proximity Sensor | PSA8A000 |
| MB4 | Mounting Bracket for PSA7 | MB400000 |
| MB5 | Mounting Bracket for PSA8 | MB500000 |



Do not dispose of unit in trash - Recycle

LIMITED WARRANTY

The Company warrants the products it manufactures against defects in materials and workmanship for a period limited to two years from the date of shipment, provided the products have been stored, handled, installed, and used under proper conditions. The Company's liability under this limited warranty shall extend only to the repair or replacement of a defective product, at The Company's option. The Company disclaims all liability for any affirmation, promise or representation with respect to the products.

The customer agrees to hold Red Lion Controls harmless from, defend, and indemnify RLC against damages, claims, and expenses arising out of subsequent sales of RLC products or products containing components manufactured by RLC and based upon personal injuries, deaths, property damage, lost profits, and other matters which Buyer, its employees, or sub-contractors are or may be to any extent liable, including without limitation penalties imposed by the Consumer Product Safety Act (P.L. 92-573) and liability imposed upon any person pursuant to the Magnuson-Moss Warranty Act (P.L. 93-637), as now in effect or as amended hereafter.

No warranties expressed or implied are created with respect to The Company's products except those expressly contained herein. The Customer acknowledges the disclaimers and limitations contained herein and relies on no other warranties or affirmations.

Red Lion Controls
Headquarters
20 Willow Springs Circle
York PA 17406
Tel +1 (717) 767-6511
Fax +1 (717) 764-0839

Red Lion Controls
Europe
Softwareweg 9
NL - 3821 BN Amersfoort
Tel +31 (0) 334 723 225
Fax +31 (0) 334 893 793

Red Lion Controls
India
201-B, 2nd Floor, Park Centra
Opp 32 Mile Stone, Sector-30
Gurgaon-122002 Haryana, India
Tel +91 984 487 0503

Red Lion Controls
China
Unit 302, XinAn Plaza
Building 13, No.99 Tianzhou Road
ShangHai, P.R. China 200223
Tel +86 21 6113 3688
Fax +86 21 6113 3683