



**Rack Dimension**

L	*	W	*	H
483.6	*	350.8	*	44 (1U) mm
19	*	13.8	*	1.73(1U) inch



**Features**

- Universal AC input / Full range
- 1U profile 19" rack shelf, fitting three 2000W modules up to 6000W with active current sharing
- Output voltage programmable
- Support hot swap (hot plug)
- Built-in PMBus protocol
- 5 years warranty

**Applications**

- Industrial automation
- Distributed power architecture system
- Wireless/telecommunication solution
- Redundant power system
- Electric vehicle charger system
- Constant current source system

**Description**

RKP-1U rack system is a power distribution solution utilizing the rack configuration with 1U low profile. Starting with a single unit of 2000W, RCP-2000 is the front end rectifier (or, power supply). With the active current sharing function, up to 6000W is able to be provided by 1 stack of the 19" rack mountable shelf RKP-1U and 18000W by 3 stacks. The design flexibility for system applications is ideally fulfilled by various built-in features, such as output programming, communication protocol PMBus, remote ON-OFF, auxiliary power, external control/monitor via the control model RCP-CMU-1, etc.

**Model Encoding**

**Rack Shelf:**  
RKP-1U I -CMU1

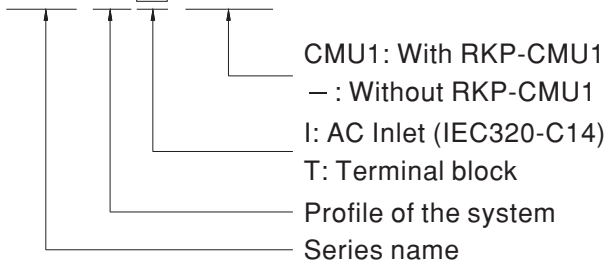

**Whole System:**  
RKP-6K1U I -CMU1-12

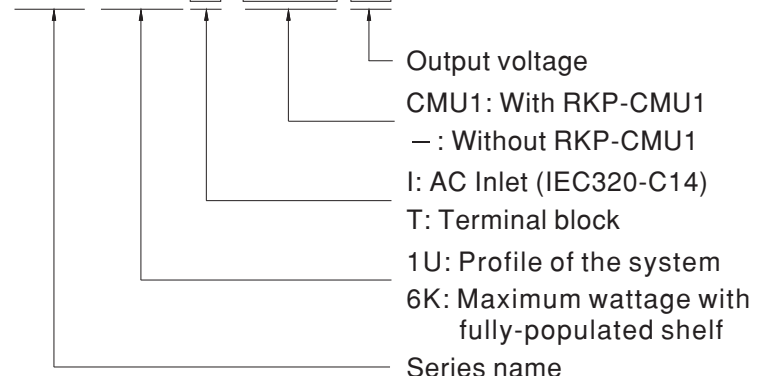



## SPECIFICATION - Power Supply System

MODEL		RKP-6K1U□-12	RKP-6K1U□-24	RKP-6K1U□-48	
OUTPUT	RECTIFIER	RCP-2000-12	RCP-2000-24	RCP-2000-48	
	RACK SHELF	RKP-1UI or RKP-1UT			
	OUTPUT VOLTAGE	12V	24V	48V	
	MAX. OUTPUT CURRENT	300A	240A	126A	
	MAX. OUTPUT POWER <small>Note.7</small>	3600W	5760W	6048W	
INPUT	VOLTAGE RANGE <small>Note.6</small>	90 ~ 264VAC 127 ~ 370VDC			
	FREQUENCY RANGE	47 ~ 63Hz			
	AC CURRENT (Typ.)/PER MODULE	13A/115VAC 7A/230VAC	16A/115VAC 11A/230VAC	16A/115VAC 11A/230VAC	
	LEAKAGE CURRENT	<3.5mA / 230VAC			
FUNCTION	AUXILIARY POWER	5V @ 0.3A, 12V @ 0.8A			
	REMOTE ON-OFF CONTROL	By electrical signal or dry contact ON:short OFF:open			
	REMOTE SENSE	Compensate voltage drop on the load wiring up to 0.5V.			
	OUTPUT VOLTAGE PROGRAMMABLE	Adjustment of output voltage is allowable to 90 ~ 110% of nominal output voltage. Please refer to the Function Manual.			
	DC OK SIGNAL	The isolated TTL signal out, Please refer to the Installation Manual			
	AC OK SIGNAL	The isolated TTL signal out, Please refer to the Installation Manual			
	OVER TEMP WARNING	Logic " High" for over temperature warning, Please refer to the Installation Manual, isolated signal			
	FAN FAIL SIGNAL	The isolated TTL signal out, Please refer to the Installation Manual			
ENVIRONMENT	WORKING TEMP.	-40 ~ +70°C (Refer to "Derating Curve")			
	WORKING HUMIDITY	20 ~ 90% RH non-condensing			
	STORAGE TEMP., HUMIDITY	-40 ~ +85°C, 10 ~ 95% RH			
	TEMP. COEFFICIENT	±0.03%/°C (0 ~ 50°C)			
	VIBRATION	10 ~ 500Hz, 2G 10min./1cycle, 60min. each along X, Y, Z axes			
SAFETY & EMC (Note 5)	SAFETY STANDARDS	UL60950-1, TUV EN60950-1 approved			
	WITHSTAND VOLTAGE	I/P-O/P:3KVAC I/P-FG:2KVAC O/P-FG:0.7KVDC			
	ISOLATION RESISTANCE	I/P-O/P, I/P-FG, O/P-FG:100M Ohms / 500VDC / 25°C / 70% RH			
	EMC EMISSION	Parameter	Standard	Test Level / Note	
		Conducted	EN55022 (CISPR22) / EN55011 (CISPR11)	Class A	
		Radiated	EN55022 (CISPR22) / EN55011 (CISPR11)	Class A	
		Harmonic Current	EN61000-3-2	-----	
		Voltage Flicker	EN61000-3-3	-----	
	EMC IMMUNITY	EN55024, EN61204-3, EN61000-6-2			
		Parameter	Standard	Test Level / Note	
		ESD	EN61000-4-2	Level 3, 8KV air ; Level 2, 4KV contact	
		Radiated	EN61000-4-3	Level 3	
		EFT / Burst	EN61000-4-4	Level 3	
		Surge	EN61000-4-5	Level 4, 4KV/Line-Earth ; Level 3, 2KV/Line-Line	
Conducted		EN61000-4-6	Level 3		
Magnetic Field		EN61000-4-8	Level 4		
Voltage Dips and Interruptions	EN61000-4-11	>95% dip 0.5 periods, 30% dip 25 periods, >95% interruptions 250 periods			
OTHERS	DIMENSION	Rack 483.6*350.8*44(L*W*H)			
	PACKING	14.1Kg; 1pcs/14.1Kg/2.67CUFT			
NOTE	<ol style="list-style-type: none"> <li>All parameters NOT specially mentioned are measured at 230VAC input, rated load and 25°C of ambient temperature.</li> <li>Ripple &amp; noise are measured at 20MHz of bandwidth by using a 12" twisted pair-wire terminated with a 0.1uf &amp; 47uf parallel capacitor.</li> <li>Under parallel operation of more than one rack connecting together, ripple of the output voltage may be higher than the SPEC at light load condition. It will go back to normal ripple level once the output load is more than 10%.</li> <li>Tolerance : includes set up tolerance, line regulation and load regulation.</li> <li>The power supply is considered a component which will be installed into a final equipment. All the EMC tests are been executed by mounting the unit on a 720mm*360mm metal plate with 1mm of thickness. The final equipment must be re-confirmed that it still meets EMC directives. For guidance on how to perform these EMC tests, please refer to "EMI testing of component power supplies." (as available on <a href="http://www.meanwell.com">http://www.meanwell.com</a>)</li> <li>Derating may be needed under low input voltages. Please check the static characteristics for more details.</li> <li>Output of all the RCP-2000 modules are connected in parallel in the rack.</li> <li>Because of component tolerance, there is a possibility that some of the units connected in parallel will reach the overcurrent limit and others enter overload in turn when operating at full load condition. If overload conditions happen in parallel usage, it is suggested that derate the total output current by 10%.</li> </ol>				

## Function Manual

### 1. Voltage Drop Compensation

#### 1.1 Remote Sense

The remote sense compensates voltage drop on the load wiring up to 0.5V.

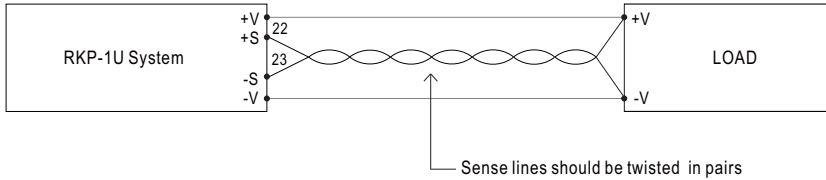

#### 1.2 Local Sense

Notice : The +S,-S on CN500 have to be connected to the +V(signal),-V(signal),respectively, in order to get the correct output voltage if the remote sensing is not used.

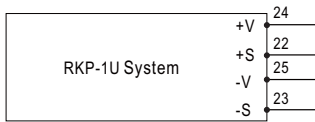

### 2. Output Voltage Programming (or, PV / remote voltage programming / remote adjust / margin programming / dynamic voltage trim)

- (1)Connecting an external DC source between PV(4,10,19) and -V(25) on CN500 that is shown in Fig. 3.1.
- (2)Adjustment of output voltage is possible between 90~110%(Typ.) of the nominal voltage which is shown in Fig. 3.2. Reducing output current is required when the output voltage is trimmed up.

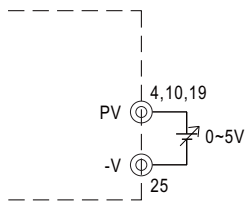

Fig. 2.1 Add on 0~5V external voltage

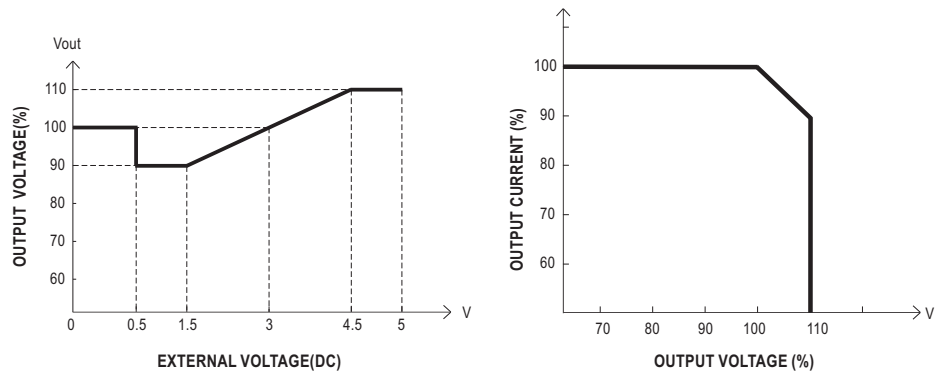
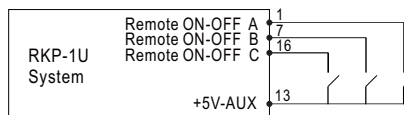
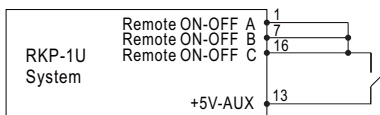

Fig. 2.2 Output voltage trimming

### 3. Remote ON-OFF Control

The power supply can be turned ON/OFF together or separately by using the "Remote ON-OFF" function.



Between Remote ON-OFF and +5V-AUX	Output
Switch Open	OFF
Switch Short	ON

### 4.PMBus Communication Interface

※ RCP-2000 supports PMBus Rev. 1.1 with maximum 100KHz bus speed, allowing information reading, status monitoring and output trimming. For details, please refer to the Installation Manual.

■ Mechanical Specification (Rack System)

Case No. 959A Unit:mm

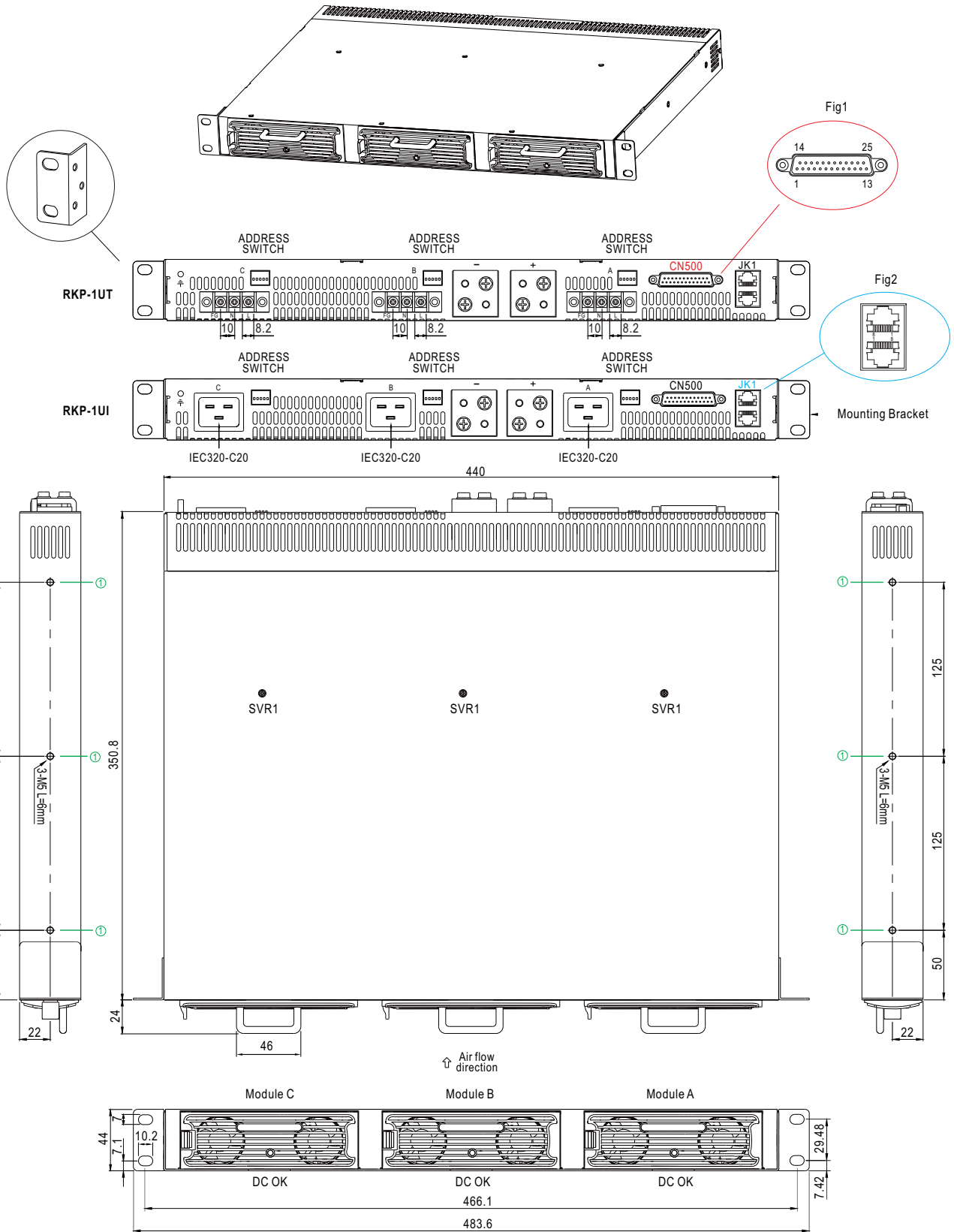

※ Mounting Instruction

Hole No.	Recommended Screw Size	MAX. Penetration Depth L	Recommended mounting torque
①	M5	6mm	10Kgf-cm

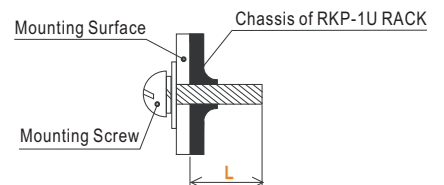

※ LED Status Indicators & Corresponding Signal at Function Pins

Function	LED	Description	* Signal	PSU Output
AC-OK	● GREEN	When input voltage $\geq 87V$	0 ~ 0.5V	ON
AC-NG	● RED	When input voltage $\leq 75V$	4.5 ~ 5.5V	OFF
DC-OK	● GREEN	When output voltage $\geq 80\% \pm 5\%$ of $V_o$ rated.	0 ~ 0.5V	ON
DC-NG	● RED	When output voltage $\leq 80\% \pm 5\%$ of $V_o$ rated.	4.5 ~ 5.5V	ON
T-OK	● GREEN	When the internal temperature (TSW1 & TSW2 short) is within safe limit	0 ~ 0.5V	ON
T-ALARM	● RED	When the internal temperature (TSW1 or TSW2 open) exceeds the limit of temperature alarm	4.5 ~ 5.5V	OFF

\*Signal between function pin and "GND-AUX".

※ IN/OUT Connector Pin No. Assignment(CN500) : D-Type Right Angle 25 positions (female type)

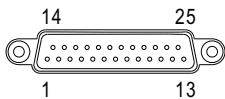

Pin No.	Function	Description
1,7,16	REMOTE ON/OFF	Each unit can separately turn the output on and off by electrical signal or dry contact between ON/OFF A,B,C(pin 1,7,16) and +5V-AUX(pin 13). Short: ON, Open:OFF. (Note.2)
2,8,17	AC-OK	Low : When the input voltage is $\geq 87V_{rms}$ . High : when the input voltage in $\leq 75V_{rms}$ . (Note.2)
3,9,18	DC-OK	High : When the $V_{out} \leq 80 \pm 5\%$ . Low : When $V_{out} \geq 80 \pm 5\%$ . (Note.2)
4,10,19	PV	Connection for output voltage programming.
5,11,20	T-ALARM	High : When the internal temperature (TSW1 or TSW2 open) exceeds the limit of temperature alarm. Low : When the internal temperature (TSW1 or TSW2 short) under the limit temperature. (Note.2)
6,12,21	FAN FAIL	High : When the internal fan fail. Low : When the internal fan is normal. (Note.2)
13	+5V-AUX	Auxiliary voltage output, 4.5 ~ 5.5V, referenced to GND-AUX (pin 15). The maximum load current is 0.3A. This output has the built-in "Oring diodes" and is not controlled by the remote ON/OFF control.
14	+12V-AUX	Auxiliary voltage output, 10.8 ~ 13.2V, referenced to GND-AUX (pin 15). The maximum load current is 0.8A. This output has the built-in "Oring diodes" and is not controlled by the remote ON/OFF control.
15	GND-AUX	Auxiliary voltage output GND. The signal return is isolated from the output terminals (+V & -V).
22	+S	Positive sensing for remote sense.
23	-S	Negative sensing for remote sense.
24	+V(signal)	Positive output voltage. For local sense use only, can't be connected directly to the load.
25	-V(signal)	Negative output voltage. For local sense use only, can't be connected directly to the load.

※ IN/OUT Connector Pin No. Assignment(JK1) : RJ45 8 positions

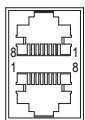

Pin No.	Function	Description
1,2	DA,DB	Differential digital signal for parallel control. (Note.1)
3	-V(signal)	Negative output voltage. For parallel control, can't be connected directly to the load.
4	CONTROL	Remote ON/OFF control pin used in the PMBus interface. (Note.2)
5	NC	Retain for future use.
6	SDA	Serial Data used in the PMBus interface. (Note.2)
7	SCL	Serial Clock used in the PMBus interface. (Note.2)
8	GND-AUX	Auxiliary voltage output GND. The signal return is isolated from the output terminals (+V & -V).

Note.1: Non-isolated signal, referenced to the -V(signal).

Note.2: Isolated signal, referenced to GND-AUX.

## ■ Installation Manual

Please refer to the manual of RKP-1U system.