

Features

Regulated Converters

- 2:1 and 3:1 Wide Input Voltage Ranges
- 1kVDC, 2kVDC and 3kVDC Isolation
- UL94V-0 Package Material
- Continuous Short Circuit Protection
- Low Ripple and Noise
- Remote On/Off Control
- Efficiency to 83 %

Description

Very high power density, 2:1 or 3:1 input voltage range and a wide operating temperature range -40°C to +71°C and extra features such as On/Off control are just some of the characteristics of this converter which is ideal for highly sophisticated industrial designs. The RS3 is available with 2kV or 3kV isolation options (1kVDC is standard)

Selection Guide

Part Number	Input Voltage Range (VDC)	Rated Output Voltage (VDC)	Output Current Full Load (mA)	Efficiency typ. (%)	Max Capacitive Load ⁽¹⁾
RS3-xx3.3S (H2/H3)	4.5-9, 9-18 18-36, 36-72	3.3	600	73-75 77-78	4700µF
RS3-xx05S (H2/H3)	4.5-9, 9-18 18-36, 36-72	5	600	76-79 80-81	4700µF
RS3-xx09S (H2/H3)	4.5-9, 9-18 18-36, 36-72	9	333	77-80 81-82	3300µF
RS3-xx12S (H2/H3)	4.5-9, 9-18 18-36, 36-72	12	250	80-81 83	2200µF
RS3-xx15S (H2/H3)	4.5-9, 9-18 18-36, 36-72	15	200	80-81 83	2200µF
RS3-xx3.3D (H2/H3)	4.5-9, 9-18 18-36, 36-72	±3.3	±300	73-75 75	±2200µF
RS3-xx05D (H2/H3)	4.5-9, 9-18 18-36, 36-72	±5	±300	76-80 80-81	±2200µF
RS3-xx09D (H2/H3)	4.5-9, 9-18 18-36, 36-72	±9	±167	77-81 81	±2200µF
RS3-xx12D (H2/H3)	4.5-9, 9-18 18-36, 36-72	±12	±125	78-83 83	±1000µF
RS3-xx15D (H2/H3)	4.5-9, 9-18 18-36, 36-72	±15	±100	79-83 83	±1000µF
RS3-xx3.3SZ (H2/H3)	9-27 20-60	3.3	600	73 74	4700µF
RS3-xx05SZ (H2/H3)	9-27 20-60	5	600	76-79 78	4700µF
RS3-xx09SZ (H2/H3)	9-27 20-60	9	333	77 79	3300µF
RS3-xx12SZ (H2/H3)	9-27 20-60	12	250	80 80	2200µF
RS3-xx15SZ (H2/H3)	9-27 20-60	15	200	80 80	2200µF
RS3-xx3.3DZ (H2/H3)	9-27 20-60	±3.3	±300	73 74	±2200µF
RS3-xx05DZ (H2/H3)	9-27 20-60	±5	±300	77 78	±2200µF
RS3-xx09DZ (H2/H3)	9-27 20-60	±9	±167	79 79	±2200µF
RS3-xx12DZ (H2/H3)	9-27 20-60	±12	±125	80 80	±1000µF
RS3-xx15DZ (H2/H3)	9-27 20-60	±15	±100	80 80	±1000µF

No suffix is standard isolation (1kVDC) e.g, RS3-0505S

*add suffix /H2 or /H3 for 2kVDC or 3kVDC isolation, e.g, RS3-0505S/H2, R3S-0505DZ/H3

ECONOLINE

DC/DC-Converter

with 3 year Warranty

RECOM

3 Watt SIP8 Isolated Single & Dual Output



UL-60950-1 Certified
EN-60950-1 Certified
EN-60601-1 Certified*
(* /H suffix)

RS3

Derating-Graph

(Ambient Temperature)

RS3-(Z)S_D

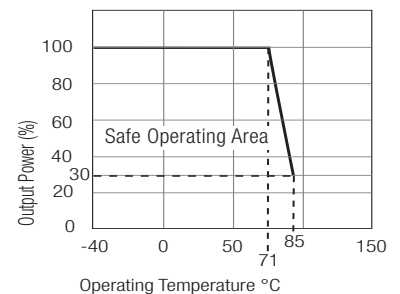

2:1 Input
(RS3-S/D)

xx = 4.5-9Vin = 05
xx = 9-18Vin = 12
xx = 18-36Vin = 24
xx = 36-72Vin = 48

3:1 Input
(RS3-SZ/DZ)

xx = 9-27Vin = 24
xx = 20-60Vin = 48

Electrical Specifications (measured at $T_A = 25^\circ\text{C}$, at nominal input voltage and rated output current unless otherwise specified)

Input Voltage Range		2:1 and 3:1	
Output Accuracy	Nominal V_{in} and full load	$\pm 2\%$ typ.	
Line Voltage Regulation	LL to HL, full load	$\pm 0.5\%$ max.	
Load Voltage Regulation	20% to 100% full load	$\pm 0.5\%$ typ.	
Minimum Load		10% ⁽²⁾	
Output Ripple and Noise	20MHz limited	50mVp-p max.	
Switching Frequency	20% to 100% full load	200kHz typ.	
Efficiency at Full Load		see Selection Guide	
Quiescent Current	RS3-05xxS_D	35mA typ.	
Nominal input Voltage (Standard, /H2 and /H3)	RS3-12xxS_D	25mA typ.	
	RS3-24xxS_D, SZ_DZ	20mA typ.	
	RS3-48xxS_D, SZ_DZ	10mA typ.	
Isolation Voltage	Standard	(tested for 1 second) (rated for 1 minute*) 1000VDC 500VAC / 60Hz	
	/H2 Version	(tested for 1 second) (rated for 1 minute*) 2000VDC 1000VAC / 60Hz	
	/H3 Version	(tested for 1 second) (rated for 1 minute*) 3000VDC 1500VAC / 60Hz	
Isolation Capacitance (2:1 and 3:1) (tested at 100kHz)	H1	200pF max.	
	H2/H3	30pF max.	
Isolation Resistance		1G Ω min.	
Short Circuit Protection (see note)		Continuous	
Operating Temperature Range		-40°C to $+71^\circ\text{C}$	
Storage Temperature Range		-55°C to $+125^\circ\text{C}$	
Relative Humidity		95% RH	
Package Weight		4.7g	
Packing Quantity		22 pcs per Tube	
MTBF ($+25^\circ\text{C}$) ($+71^\circ\text{C}$)	} Detailed Information see Application Notes chapter "MTBF"	using MIL-HDBK 217F	3303 x10 ³ hours
		using MIL-HDBK 217F	745 x10 ³ hours
Certifications			
EN General Safety	Report: SPCLVD1605077-10	EN60950-1, AM2:2013	
EN Medical Safety	Report: MDD1205098-3 + RM1205098-3	IEC/EN 60601-1 3rd Edition Medical Report + ISO14971 Risk Assessment	
UL General Safety	Report: E224736-A34	UL60950-1, 2nd Edition 2014 CSA C22.2 60950-1-07, 2nd Edition 2014	

Note: To protect the converter under all fault conditions, an input fuse is required. Quick-blow fuses should be rated at 2x-3x the normal input current, time-delay fuses at 1.5x the normal input current.

Notes

- Note 1: Maximum capacitive load is defined as the capacitive load that will allow start up in under 1 second without damage to the converter
- Note 2: The RS3 series requires a minimum of 10% load on the output to maintain specified regulation. Operating under no-load conditions will not damage these devices; however, they may not meet all listed specifications.

Typical Application

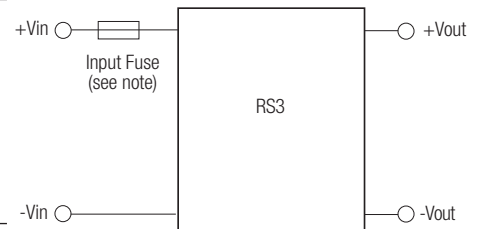

**Any data referred to in this datasheet are of indicative nature and based on our practical experience only. For further details, please refer to our Application Notes.

Typical Characteristics

RS3-0505S

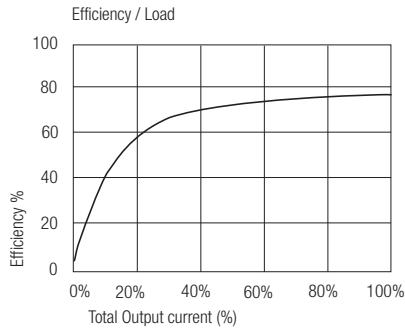

RS3-4805D

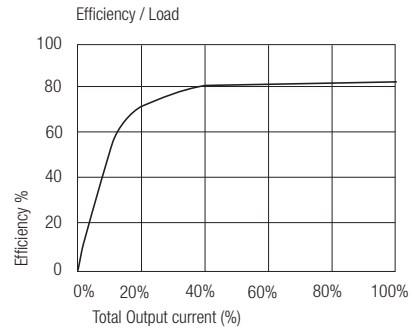

Package Style and Pinning (mm)

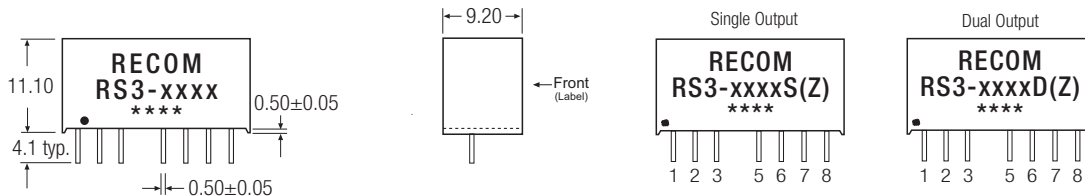

Recommended Footprint Details

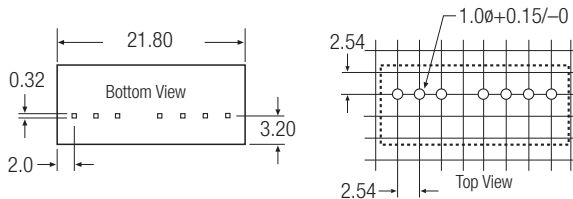

Pin Connections

Pin #	Single	Dual
1	-Vin	-Vin
2	+Vin	+Vin
3	CTRL	CTRL
5	NC	NC
6	+Vout	+Vout
7	-Vout	Com
8	NC	-Vout

NC = No Connection

XX.X ± 0.5 mm
XX.XX ± 0.25 mm

Pin 8 (NC*) This pin is used internally and must have no external connection.

Pin 5 (NC) Not connected internally.

Pin 3 (CTRL)

This pin provides an Off function which puts the converter into a low power mode. When the pin is 'high' the converter is OFF and when the pin is high 'Z' the converter is ON. There is no allowed low state for this pin.

Application Examples

ON/OFF CONTROL

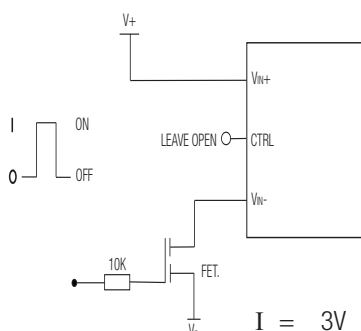

I = 3V
O = 0.5V or GND

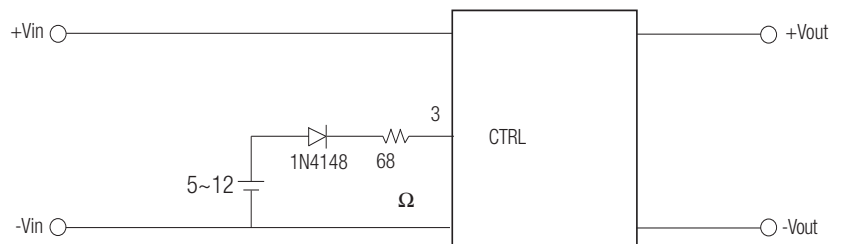

Remote ON/OFF

ON: open or high impedance

OFF: external 5~12Vdc and 1N4148+ 68Ω resistor

The product information and specifications are subject to change without prior notice. RECOM products are not authorized for use in safety-critical applications (such as life support) without RECOM's explicit written consent. A safety-critical application is defined as an application where a failure of a RECOM product may reasonably be expected to endanger or cause loss of life, inflict bodily harm or damage property. The buyer shall indemnify and hold harmless RECOM, its affiliated companies and its representatives against any damage claims in connection with the unauthorized use of RECOM products in such safety-critical applications.