

**SF2164E**

**1484.3 MHz  
SAW Filter**

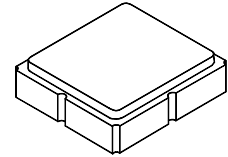

**SM3030-8**

- SAW Filter for Digital Television
- Complies with Directive 2002/95/EC (RoHS)



**Characteristics:**

Differential Source and Load Configuration

Terminating Source/Load Impedance :  $Z_S = 150 \Omega$

**Maximum Rating**

Rating	Value	Units
Input Power Level	+10	dBm
DC Voltage on any Non-ground Terminal	3	V
Operating Temperature Range	-40 to +85	°C
Storage Temperature Range	-50 to +95	°C
Suitable for Lead-free Soldering - Maximum Soldering Profile	260 °C for 30 s	

**Electrical Characteristics**

Characteristic	Sym	Notes	Min	Typ	Max	Units
Center Frequency	$f_C$			1484.3		MHz
Insertion Loss, 1464.3 to 1504.3 MHz	IL			2.0	4.5	dB
Amplitude Ripple, 1464.3 to 1504.3 MHz		1		0.6	2.0	dB
Phase Error, 1464.3 to 1504.3 MHz		1		3.2	6.0	deg
Input/Output VSWR, 1464.3 to 1504.3 MHz				2:1	2.5:1	
2 dB Bandwidth			40	60		MHz
Attenuation Referenced to 0 dB:						
50 to 1402.3 MHz			48	60		dB
1566.3 to 1810.5 MHz			50	60		
1810.5 to 4250 MHz			55	65		
4250 to 6000 MHz			30	38		

Case Style	SM3030-8 3.0 x 3.0 mm Nominal Footprint					
Lid Symbolization, Y=year, WW=week, S=shift, dot=pin 1 indicator	860, YWWS					
Standard Reel Quantity	Reel Size 7 Inch	500 Pieces/Reel				
	Reel Size 13 Inch	3000 Pieces/Reel				

**Electrical Connections**

	Connection	Terminals
Port 1	Balanced Input	1,2
Port 2	Balanced Output	5,6
	Ground	All Others

Dot Indicates Pin 1



**CAUTION: Electrostatic Sensitive Device. Observe precautions for handling.**

**NOTES:**

1. Specification applies to any 30 MHz segment within the passband.
2. US and international patents may apply.
3. Murata, stylized Murata logo, and Murata N.A., Inc. are registered trademarks of Murata Manufacturing Co., Ltd.

## Passband Amplitude and SWR Response

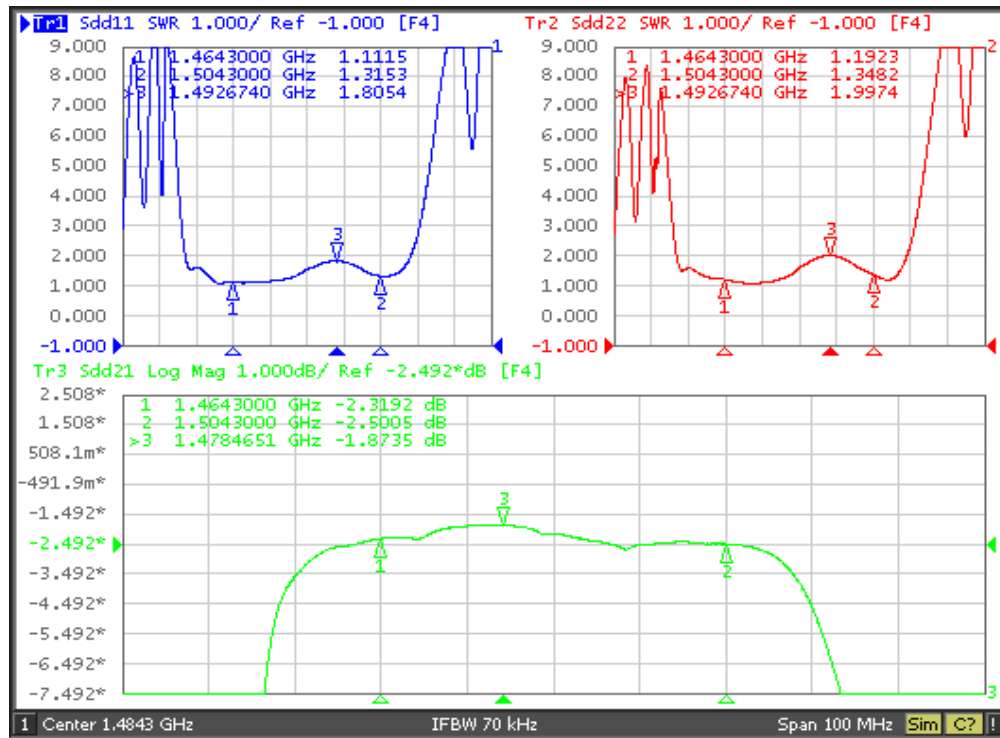

## Broadband Response

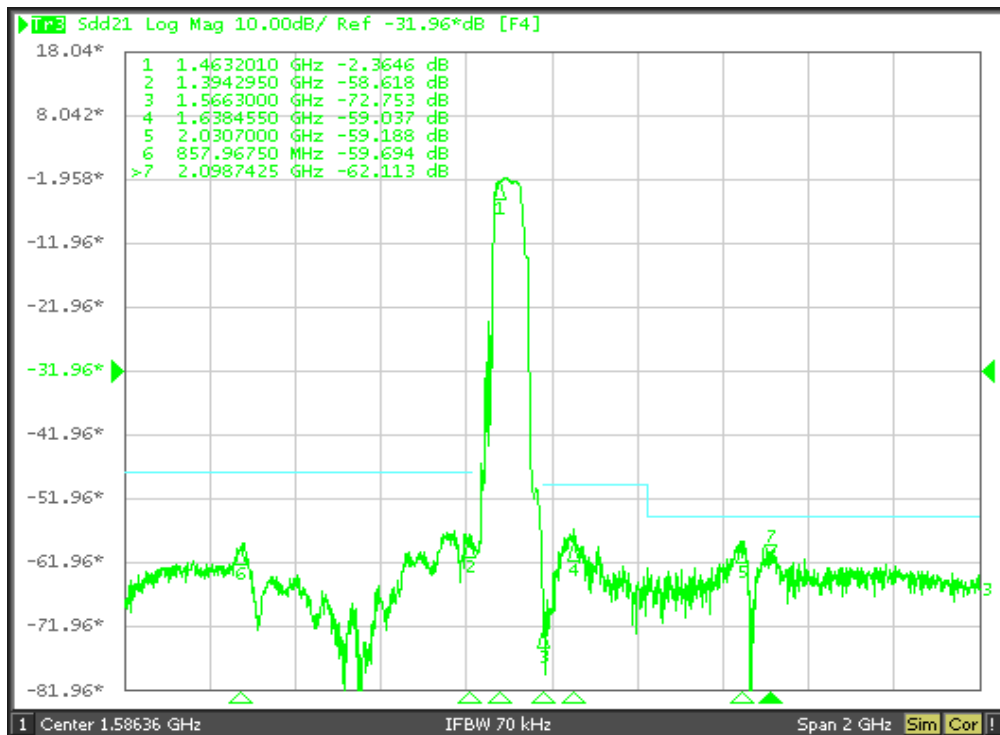

## S<sub>11</sub>, S<sub>22</sub> and S<sub>21</sub> Plots

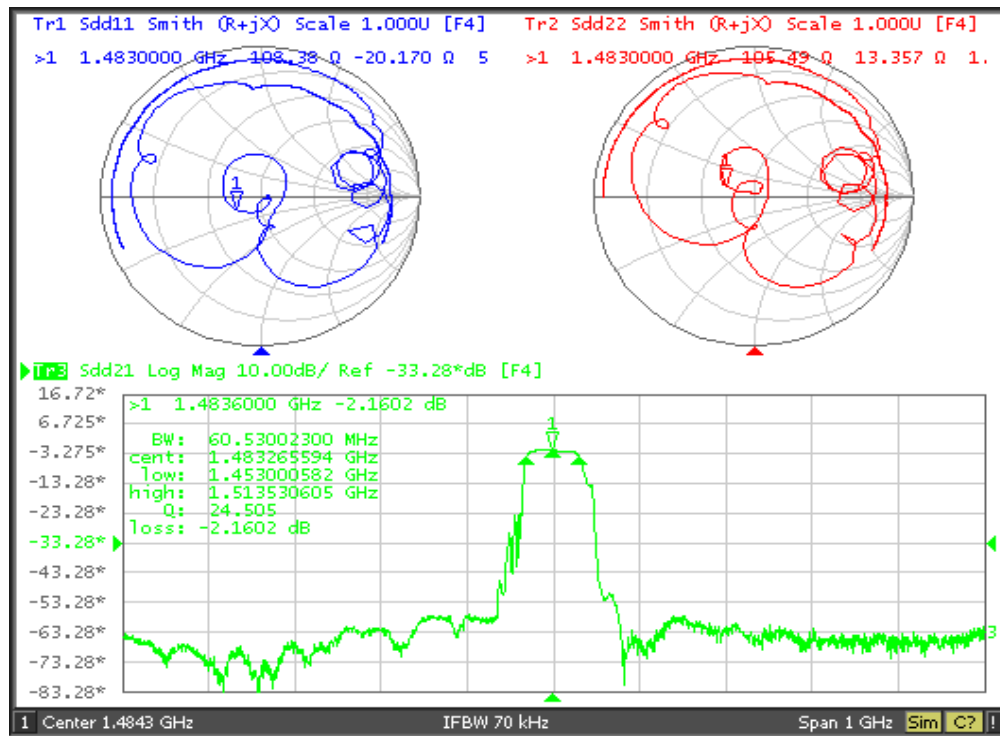

## Test Circuit, Bottom View

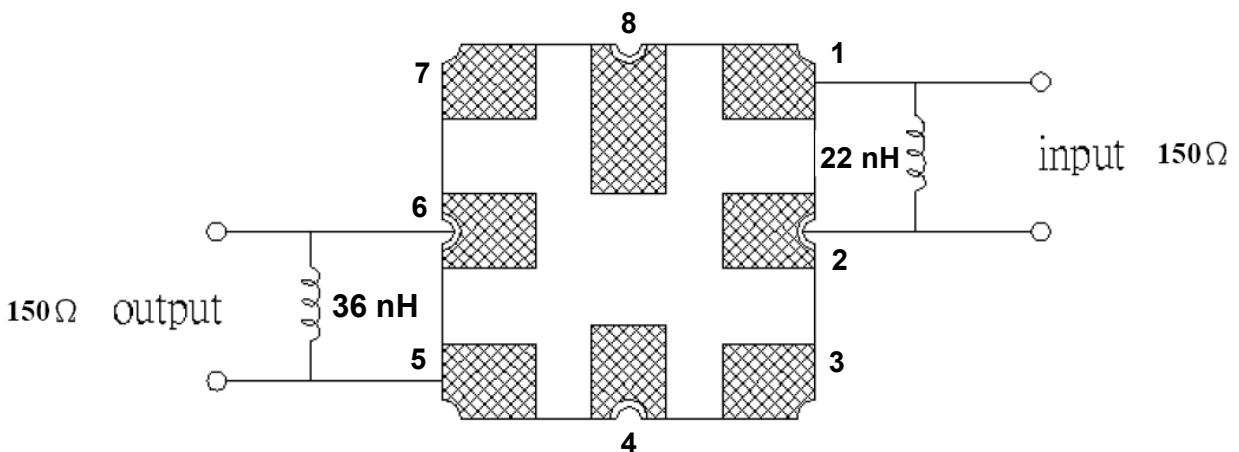

## 8-Terminal Ceramic Surface-Mount Case 3.0 X 3.0 mm Nominal Footprint

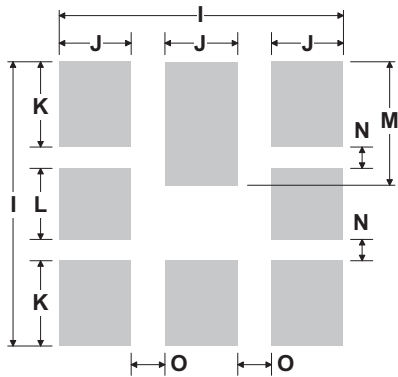
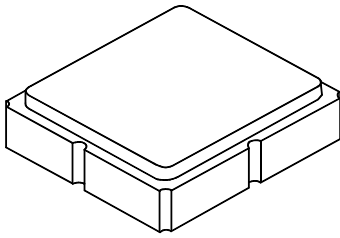

**PCB Footprint Top View**

### Case and PCB Footprint Dimensions

Dimension	mm			Inches		
	Min	Nom	Max	Min	Nom	Max
A	2.87	3.0	3.13	0.113	0.118	0.123
B	2.87	3.0	3.13	0.113	0.118	0.123
C	1.14	1.27	1.40	0.045	0.050	0.055
D	0.79	0.92	1.05	0.031	0.036	0.041
E	0.62	0.75	0.88	0.024	0.029	0.034
F	0.47	0.60	0.73	0.018	0.024	0.029
G	0.47	0.60	0.73	0.018	0.024	0.029
H	1.07	1.20	1.33	0.042	0.047	0.052
I		3.19			0.126	
J		0.81			0.032	
K		0.96			0.038	
L		0.81			0.032	
M		1.39			0.055	
N		0.23			0.009	
O		0.38			0.015	

### Case Materials

Materials	
Solder Pad Plating	0.3 to 1.0 $\mu\text{m}$ Gold over 1.27 to 8.89 $\mu\text{m}$ Nickel
Lid Plating	2.0 to 3.0 $\mu\text{m}$ Nickel
Body	$\text{Al}_2\text{O}_3$ Ceramic
Pb Free	

**TOP VIEW**

**BOTTOM VIEW**

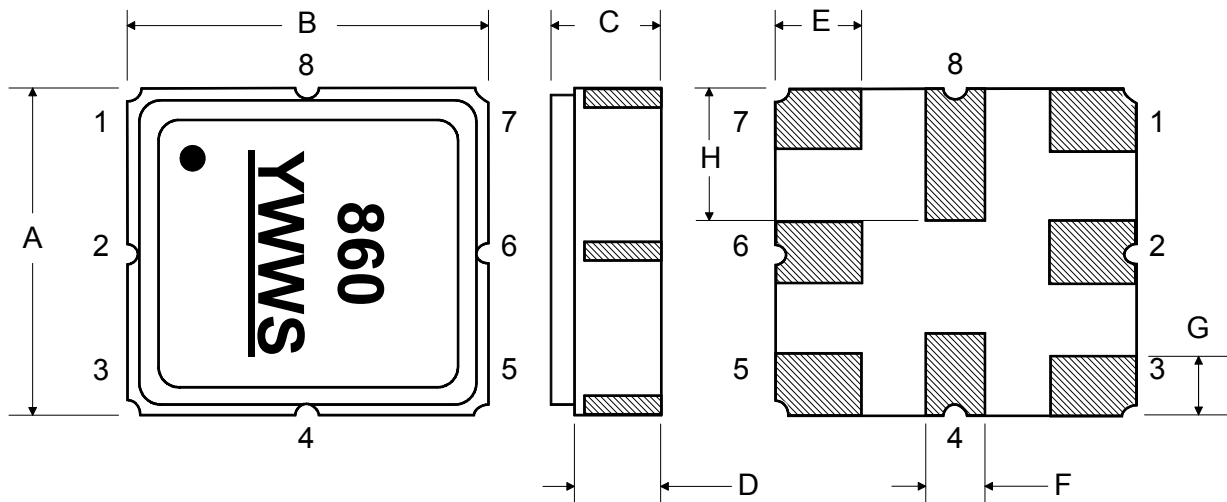

## Tape and Reel Specifications

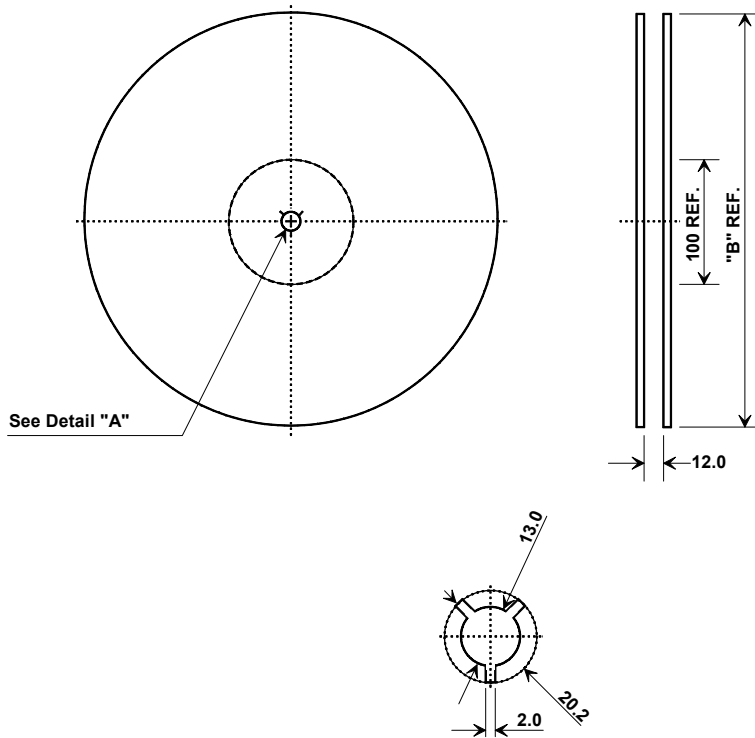

"B"		Quantity Per Reel
Inches	millimeters	
7	178	500
13	330	3000

## COMPONENT ORIENTATION and DIMENSIONS

Carrier Tape Dimensions	
Ao	3.35 mm
Bo	3.35 mm
Ko	1.4 mm
Pitch	8.0 mm
W	12.0 mm

