

# Fast Switching SCR T72H\_48

475A Avg.  
(750 RMS)  
Up to 800 Volts  
20-40  $\mu$ s

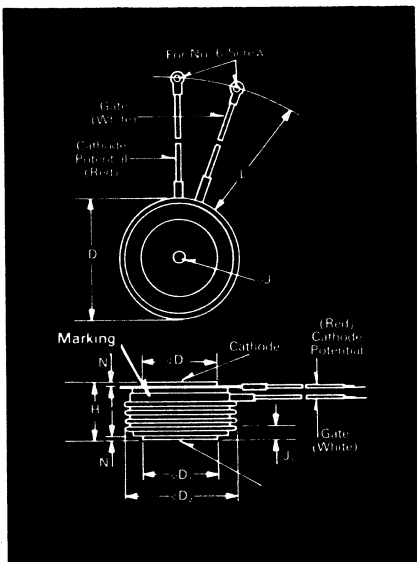

Symbol	Inches		Millimeters	
	Min.	Max.	Min.	Max.
$\phi D$	2.250	2.290	57.15	58.17
$\phi D_1$	1.333	1.343	33.86	34.11
$\phi D_2$	2.030	2.090	51.56	53.09
H	1.020	1.060	25.91	26.92
$\phi J$	.135	.145	3.43	3.68
$J_1$	.075	.090	1.91	2.29
L	7.75	8.50	196.85	215.90
N	.040		1.02	

Creep Distance—1.00 in. min. (25.40 mm).  
Strike Distance—.69 in. min. (17.53 mm).  
(In accordance with NEMA standards.)  
Finish—Nickel Plate.  
Approx. Weight—8 oz. (227 g).  
1. Dimension "H" is a clamped dimension.

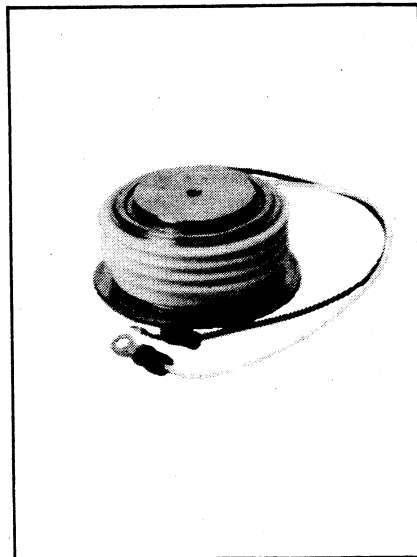

## T72 Outline

### Features:

- Interdigitated, di/namic Gate structure
- Hard Commutation Turn-Off
- Forward Blocking Voltage Capabilities to 800 Volts
- Low Switching Losses at High Frequency
- Soft Commutation (Feedback Diode) Testing Available
- High di/dt with soft gate control

### Applications:

- Induction Heating
- Transportation
- Inverters

## Ordering Information

Type	Voltage		Current		Turn-off		Gate current		Leads	
	VDRM and VRRM (V)	Code	I <sub>T(av)</sub> (A)	Code	t <sub>q</sub> usec	Code	I <sub>GT</sub> (ma)	Code	Case	Code
T72H	100	01	475	48	20	6	150	4	T72	DN
	200	02								
	300	03								
	400	04								
	500	05								
	600	06								
	700	07								
	800	08								

### Example

Obtain optimum device performance for your application by selecting proper Order Code.

Type T72H rated at 475 A average with V<sub>DRM</sub> = 400V  
I<sub>GT</sub> = 150 ma, t<sub>q</sub> = 30  $\mu$ sec max. and leads—order as:

Type	Voltage	Current	Turn Off	Gate Current	Leads
T 7 2 H	0 4	4 8	5	4	D N

**475A Avg.  
(750 RMS)  
Up to 800 Volts  
20-40  $\mu$ s**

**Fast Switching  
SCR  
T72H\_48**

**Voltage** ①

**Blocking State Maximums** ( $T_J = 125^\circ\text{C}$ )

Symbol	100	200	300	400	500	600	700	800
Repetitive peak forward blocking voltage, V $V_{DRM}$	100	200	300	400	500	600	700	800
Repetitive peak reverse voltage, V $V_{RRM}$	100	200	300	400	500	600	700	800
Non-repetitive transient peak reverse voltage, $t \leq 5.0$ msec, V $V_{RSM}$	200	300	400	500	600	700	800	900
Forward leakage current, mA peak $I_{DRM}$				35				
Reverse leakage current, mA peak $I_{RRM}$				35				

**Current**

**Conducting State Maximums**  
( $T_J = 125^\circ\text{C}$ )

Symbol	T72H_48
RMS forward current, A $I_{T(rms)}$	750
Ave. forward current, A $I_{T(av)}$	475
One-half cycle surge current <sup>②</sup> , A $I_{TSM}$	8000
$I^2t$ for fusing (for times $\geq 8.3$ ms) $I^2t$ , A <sup>2</sup> sec.	265,000
Forward voltage drop at $I_{TM} = 1500A$ and $T_J = 25^\circ\text{C}$ , V $V_{TM}$	1.55
Min. repetitive $di/dt$ ③④⑤ A/ $\mu$ sec $di/dt$	600

**Switching**

( $T_J = 25^\circ\text{C}$ )

Symbol	
Max. turn-off time, $I_T = 400A$ , $T_J = 125^\circ\text{C}$ $t_p = 100 \mu\text{sec}$ , $di/dt = 25$ A/ $\mu$ sec., reappplied $dv/dt = 200V/\mu\text{sec}$ . linear to $0.8 V_{DRM}$ , $\mu\text{sec}$ . ③④ $t_q$	20 to 40
Typ. delay time, $I_{TM} = 1000A$ $T_D = .8 V_{DRM}$ , $\mu\text{sec}$ $t_d$	.5
Typ turn-on-time $I_{TM} = 1000A$ , $\mu\text{sec}$ $t_{on}$	3.0
Min. critical $dv/dt$ exponential to $.8 V_{DRM}$ , $T_J = 125^\circ\text{C}$ , V/ $\mu$ sec ③④ $dv/dt$	300
Min. $di/dt$ , non-repetitive, A/ $\mu$ sec ③④⑤ $di/dt$	1200

**Gate**

**Maximum Parameters**  
( $T_J = 25^\circ\text{C}$ )

Symbol	
Gate current to trigger at $V_D = 12V$ , mA $I_{GT}$	150
Gate voltage to trigger at $V_D = 12V$ , V $V_{GT}$	3
Non-triggering gate voltage, $T_J = 125^\circ\text{C}$ , and rated $V_{DRM}$ , V $V_{GDM}$	.25
Peak forward gate current, A $I_{GTM}$	4
Peak reverse gate voltage, V $V_{GRM}$	5
Peak gate power, Watts $P_{GM}$	16
Average gate power, Watts $P_{G(av)}$	3

**Thermal and Mechanical**

Symbol	
Min., Max. oper. junction temp., $^\circ\text{C}$ $T_J$	-40 to +125
Min., Max. storage temp., $^\circ\text{C}$ $T_{stg}$	-40 to +150
Max. mounting force, lb. ①	2000 to 2400
Thermal resistance <sup>①</sup> , double-side cooling, junction to case, $^\circ\text{C}/\text{Watt}$ $R_{\theta JC}$	.06
Case to sink, lubricated, $^\circ\text{C}/\text{Watt}$ $R_{\theta CS}$	.02

- ① Consult recommended mounting procedures.
- ② Applies for zero or negative gate bias.
- ③ Per JEDEC RS-397, 5.2.2.1.
- ④ With recommended gate drive.
- ⑤ Higher  $dv/dt$  ratings available, consult factory.
- ⑥ Per JEDEC standard RS-397, 5.2.2.6.
- ⑦ For operation with antiparallel diode, consult factory.

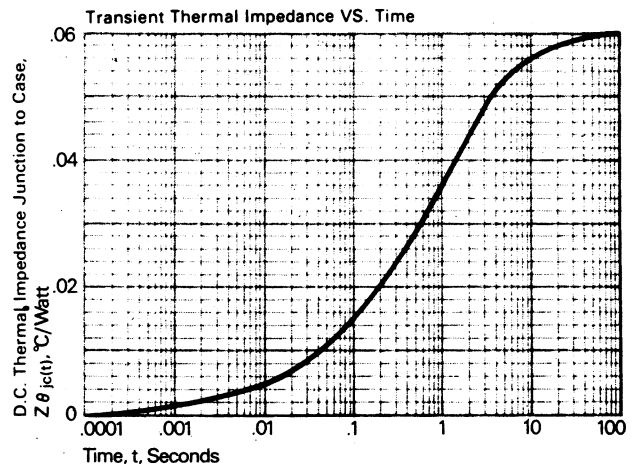
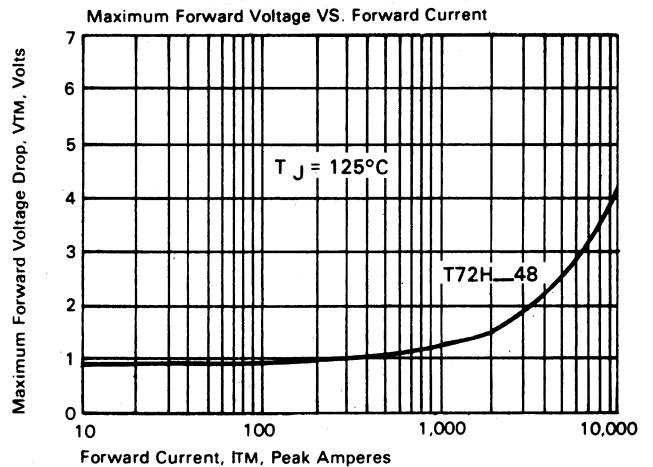

FAST SWITCHING THYRISTORS

# Fast Switching SCR T72H\_48

475A Avg.  
(750 RMS)  
Up to 800 Volts  
20-40  $\mu$ s

## Sinusoidal Current Data

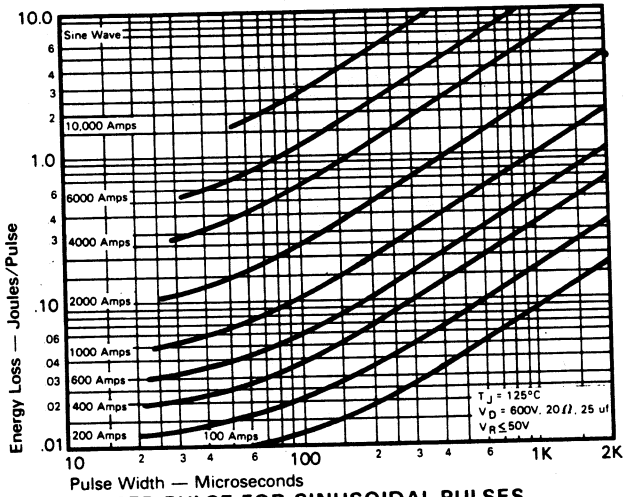

ENERGY PER PULSE FOR SINUSOIDAL PULSES

## Trapezoidal Wave Current Data

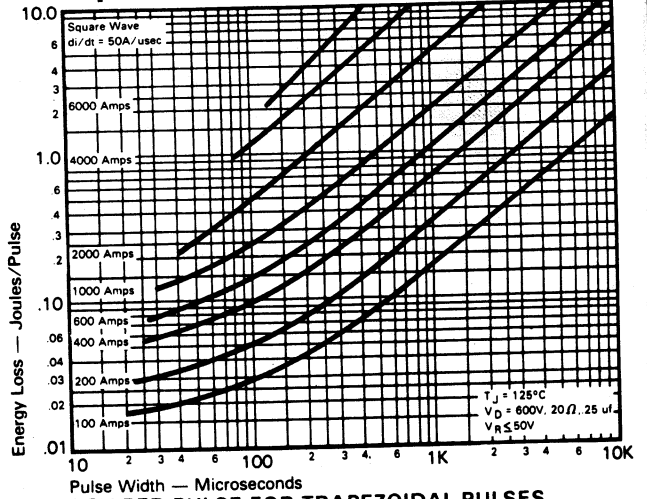

ENERGY PER PULSE FOR TRAPEZOIDAL PULSES  
( $di/dt = 50\text{A/usec}$ )

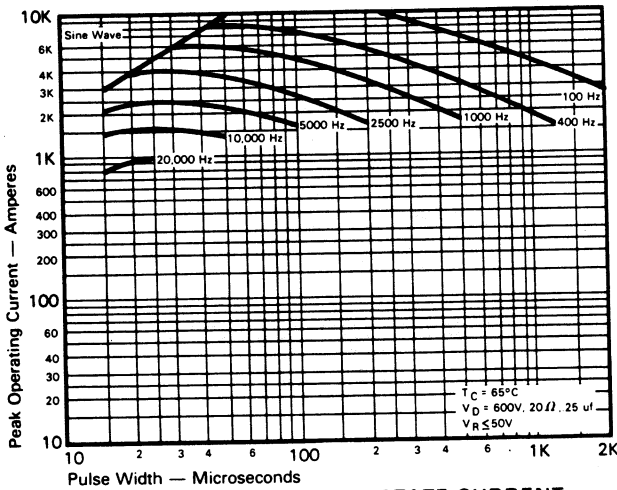

MAXIMUM ALLOWABLE PEAK ON-STATE CURRENT  
vs. PULSE WIDTH ( $T_C = 65^\circ\text{C}$ )

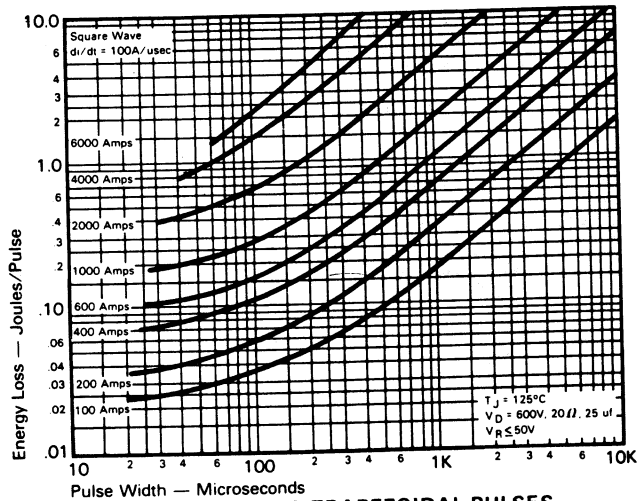

ENERGY PER PULSE FOR TRAPEZOIDAL PULSES  
( $di/dt = 100\text{A/usec}$ )

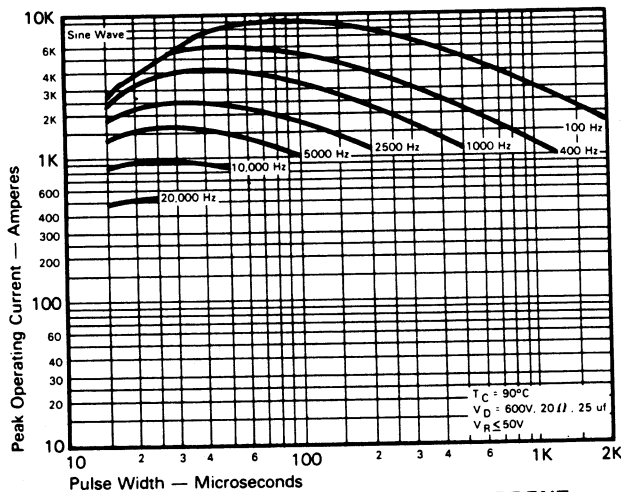

MAXIMUM ALLOWABLE PEAK ON-STATE CURRENT  
vs. PULSE WIDTH ( $T_C = 90^\circ\text{C}$ )

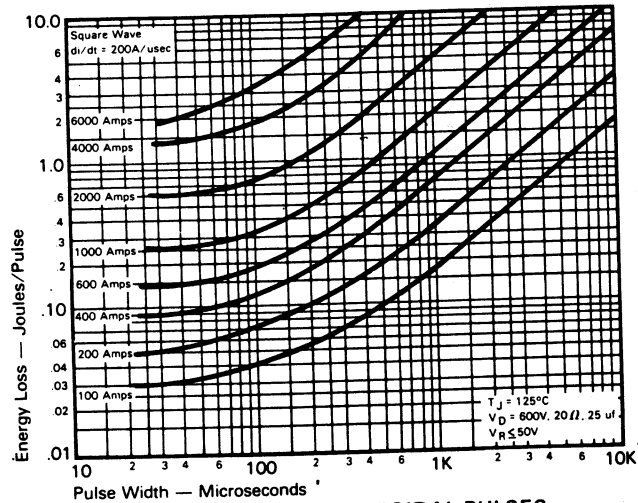

ENERGY PER PULSE FOR TRAPEZOIDAL PULSES  
( $di/dt = 200\text{A/usec}$ )

475A Avg.  
(750 RMS)  
Up to 800 Volts  
20-40  $\mu$ s

Fast Switching  
SCR  
T72H\_48

Trapezoidal Wave Current Data  
( $T_C = 65^\circ\text{C}$ )

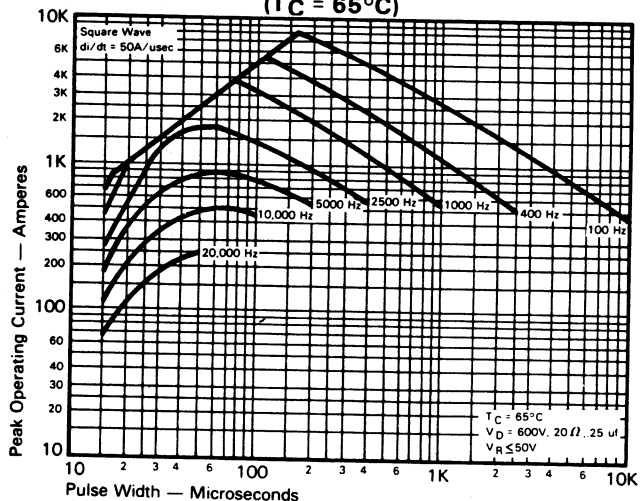

MAXIMUM ALLOWABLE PEAK ON-STATE CURRENT vs. PULSE WIDTH ( $di/dt = 50A/usec$ )

Trapezoidal Wave Current Data  
( $T_C = 90^\circ\text{C}$ )

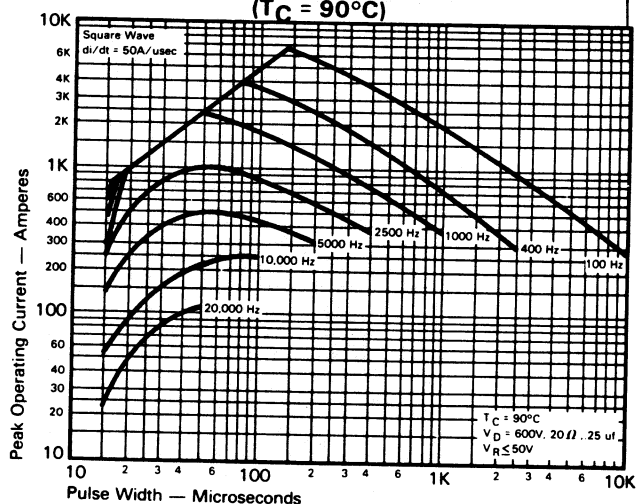

MAXIMUM ALLOWABLE PEAK ON-STATE CURRENT vs. PULSE WIDTH ( $di/dt = 50A/usec$ )

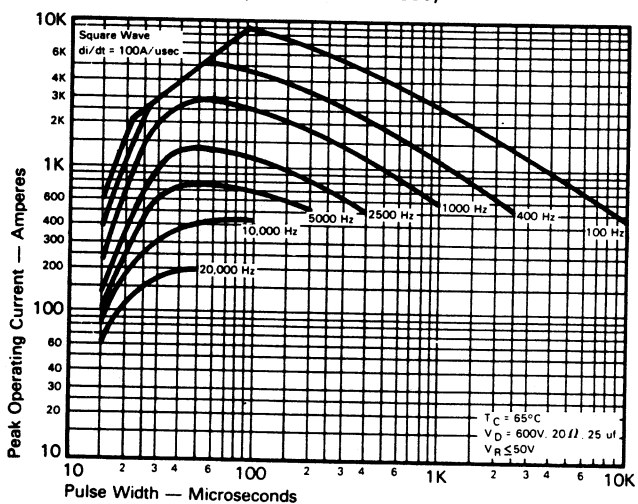

MAXIMUM ALLOWABLE PEAK ON-STATE CURRENT vs. PULSE WIDTH ( $di/dt = 100A/usec$ )

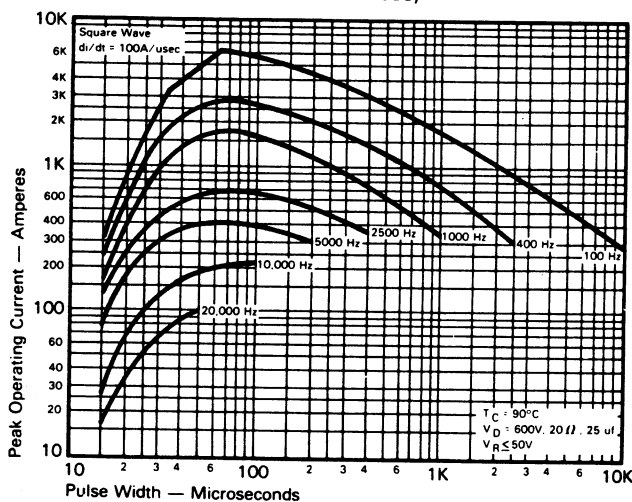

MAXIMUM ALLOWABLE PEAK ON-STATE CURRENT vs. PULSE WIDTH ( $di/dt = 100A/usec$ )

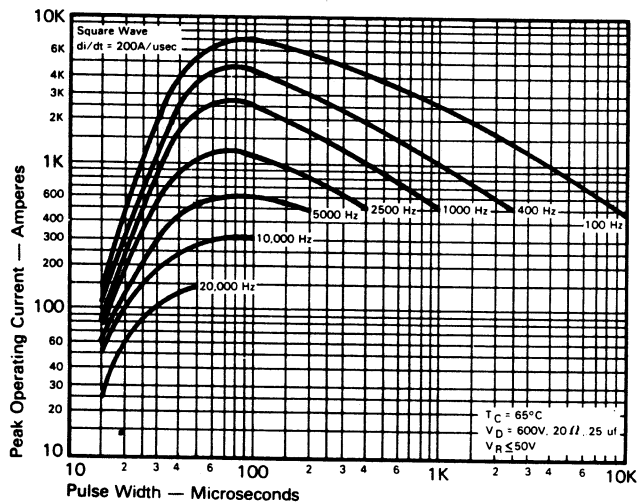

MAXIMUM ALLOWABLE PEAK ON-STATE CURRENT vs. PULSE WIDTH ( $di/dt = 200A/usec$ )

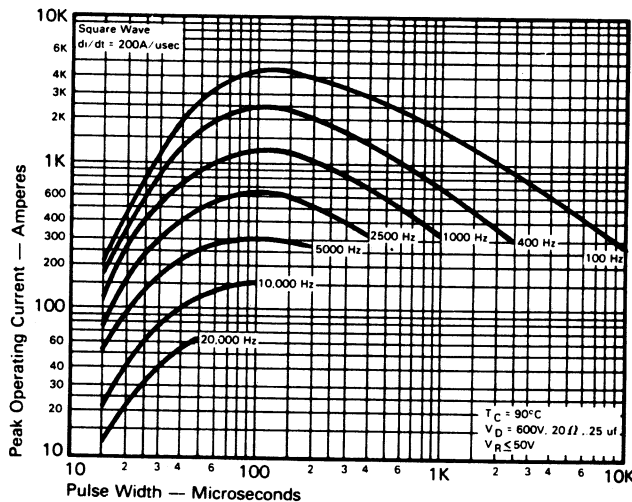

MAXIMUM ALLOWABLE PEAK ON-STATE CURRENT vs. PULSE WIDTH ( $di/dt = 200A/usec$ )

FAST SWITCHING THYRISTORS