

Three Phase Rectifier Bridge

$I_{dAV} = 85 \text{ A}$
 $V_{RRM} = 800-1600 \text{ V}$

Preliminary data

V_{RSM} V	V_{RRM} V	Types
900	800	VUO 85-08NO7
1300	1200	VUO 85-12NO7
1500	1400	VUO 85-14NO7
1700	1600	VUO 85-16NO7

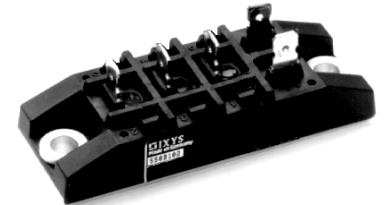
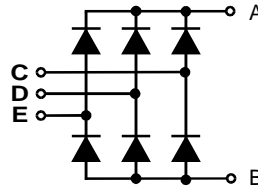

Symbol	Test Conditions	Maximum Ratings
I_{dAV} ①	$T_C = 100^\circ\text{C}$, module	85 A
I_{FSM}	$T_{VJ} = 45^\circ\text{C}$; $V_R = 0$	t = 10 ms (50 Hz), sine 750 A t = 8.3 ms (60 Hz), sine 820 A
	$T_{VJ} = T_{VJM}$ $V_R = 0$	t = 10 ms (50 Hz), sine 600 A t = 8.3 ms (60 Hz), sine 700 A
I^2t	$T_{VJ} = 45^\circ\text{C}$ $V_R = 0$	t = 10 ms (50 Hz), sine 2800 A ² s t = 8.3 ms (60 Hz), sine 2820 A ² s
	$T_{VJ} = T_{VJM}$ $V_R = 0$	t = 10 ms (50 Hz), sine 2200 A ² s t = 8.3 ms (60 Hz), sine 2250 A ² s
T_{VJ}		-40...+150 °C
T_{VJM}		150 °C
T_{stg}		-40...+125 °C
V_{ISOL}	50/60 Hz, RMS	t = 1 min 2500 V~
	$I_{ISOL} \leq 1 \text{ mA}$	t = 1 s 3000 V~
M_d	Mounting torque (M5) (10-32 UNF)	5 ± 15 % Nm 44 ± 15 % lb.in.
Weight	typ.	110 g

Features

- Package with copper base plate
- Isolation voltage 3000 V~
- Planar passivated chips
- Low forward voltage drop
- ¼" fast-on power terminals

Applications

- Supplies for DC power equipment
- Input rectifiers for PWM inverter
- Battery DC power supplies
- Field supply for DC motors

Advantages

- Easy to mount with two screws
- Space and weight savings
- Improved temperature and power cycling capability
- Small and light weight

Symbol	Test Conditions	Characteristic Values
I_R	$V_R = V_{RRM1}$; $T_{VJ} = 25^\circ\text{C}$	$\leq 0.5 \text{ mA}$
	$V_R = V_{RRM2}$; $T_{VJ} = T_{VJM}$	$\leq 10 \text{ mA}$
V_F	$I_F = 150 \text{ A}$; $T_{VJ} = 25^\circ\text{C}$	$\leq 1.6 \text{ V}$
V_{T0}	For power-loss calculations only	0.8 V
r_T		6 mΩ
R_{thJC}	per diode; DC current	1.3 K/W
	per module	0.22 K/W
R_{thJH}	per diode; DC current	1.6 K/W
	per module	0.27 K/W
d_s	Creeping distance on surface	16.1 mm
d_A	Creepage distance in air	7.5 mm
a	Max. allowable acceleration	50 m/s ²

Dimensions in mm (1 mm = 0.0394")

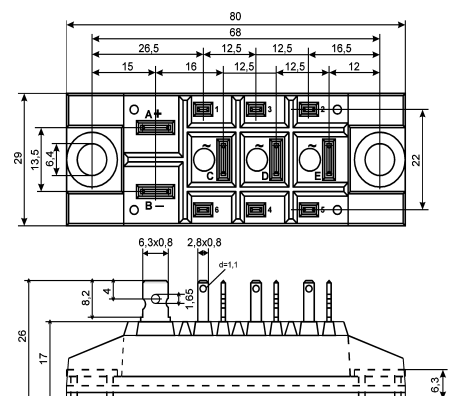

Data according to IEC 60747 refer to a single diode unless otherwise stated

① for resistive load at bridge output. IXYS reserves the right to change limits, test conditions and dimensions.