



MODEL: WT-2505
PRODUCT: Electromagnetic Buzzer
EDITION: A/2017

THIS SPECIFICATION APPLIES TO THE ELECTROMAGNETIC BUZZER

SPECIFICATION

Test condition: TEMP=+25±2 °C Related humidity=65±5% Air pressure:860 ~1060mbar

item	unit	specification	condition
rated voltage	Vo-p	6.0	
operating volt	Vo-p	4.0 ~ 6.0	
mean current	mA	80 Max	At rated voltage 730Hz, square wave, 1/2 duty
coil resistance	Ω	27±15	
sound output	dBA	85	At 10cm(A-weight free air), at rated voltage 730Hz, square wave, 1/2duty
rated frequency	Hz	730	
operating temp	°C	-30 ~ +85	
storage temp	°C	-40 ~+85	
dimension	mm	ø25.0 x H 12.5	See attached drawing
weight	gram	10.0	
material		PBT(Black)	
terminal		Pin type (Plating Sn)	See attached drawing
environmental protection regulation		RoHS	

ENVIRONMENT TEST

item	test condition	evaluation standard
high temp. test	After being placed in a chamber at +85°C for 96 hours.	After the test the part will meet specifications without any degradation in appearance and performance except SPL, after 4 hours at +25°C. The SPL will be in ±10dBA compared with initial one.
low temp. test	After being placed in a chamber at -40°C for 96 hours.	
thermal shock	The part will be subjected to 10 cycles. One cycle shall consist of:	

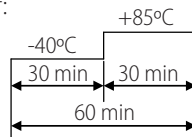

temp./humidity cycle	The part will be subjected to 10 cycles. One cycle shall be 24 hours and consist of:
----------------------	---

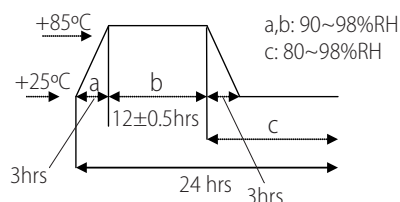



MODEL: WT-2505
PRODUCT: Electromagnetic Buzzer
EDITION: A/2017

RELIABILITY TEST

item	test conditions	evaluation standard
operating life test	ORDINARY TEMPERATURE The part will be subjected to 96 hours of continuous operation at room temperature.	After the test the part will meet specifications without any degradation in appearance and performance except SPL, after 4 hours at +25°C. The SPL would be in ±10dBA compared with initial one.
	HIGH TEMPERATURE The part will be subjected to 72 hours of continuous operation at +85°C with 6.0V, 730Hz applied.	
	LOW TEMPERATURE The part will be subjected to 72 hours of continuous operation at -30°C with 6.0V, 730Hz applied.	

TEST CONDITION

Standard Test Condition : a)Temperature: +5~+35°C b)Humidity:45~85% c)Pressure: 860~1060mbar

MECHANICAL CHARACTERISTICS

item	test condition	evaluation standard
solderability	Lead terminals are immersed in solder bath of +250±5°C for 3±1 seconds.	90% min.lead terminals will be wet with solder No interference in operation.
soldering heat resistance	Lead terminal are immersed in soldering bath of 260±5°C for 2±0.5 seconds.	
terminal mechanical strength	Apply the terminal with 1KG strength for 1 minute	No damage and cutting off.
vibration	The part will be subjected to a vibration cycle of 10Hz to 55Hz to 10Hz in a period of 1 minute. Total peak amplitude will be 1.52mm(9.3G). The vibration test will consist of 2 hours per axis in each three axes (X,Y,Z). Total 6 hours.	After the test the part will meet specifications without any damage in appearance and performance except SPL. SPL would be in ±10dBA compared with initial one.
drop test	The part only will be dropped from a height of 75cm onto a 40mm thick wooden board 3 times in 3 axes (X,Y,Z). Total of 9 times.	

RECOMMENDED TEMPERATURE PROFILE FOR REFLOW OVEN

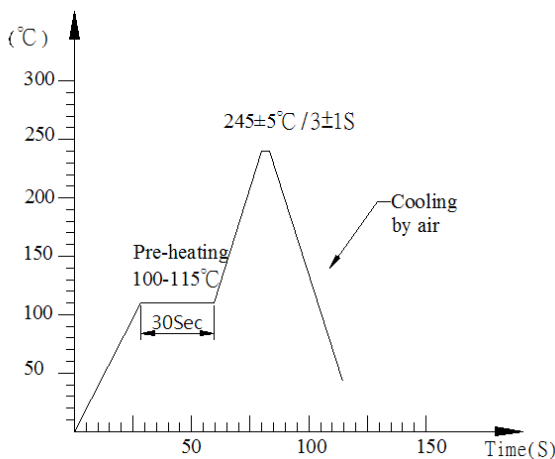

Recommendable wave soldering condition is as follows:
 Note 1: It is requested that reflow soldering should be executed after heat of product goes down to normal temperature.
 Note 2: Peak reflow temperature of 250°C maximum of 10 seconds, with a maximum duration of 40-60 seconds between 220°C and 250°C



MODEL: WT-2505
PRODUCT: Electromagnetic Buzzer
EDITION: A/2017

MEASUREMENT TEST CIRCUIT

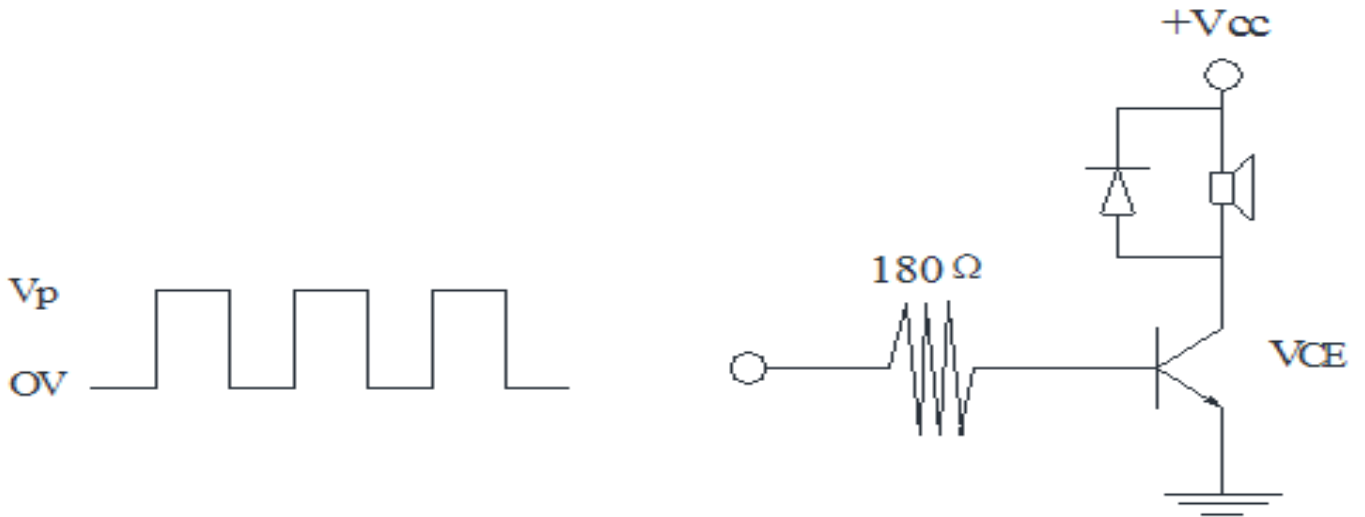

INSPECTION FIXTURE

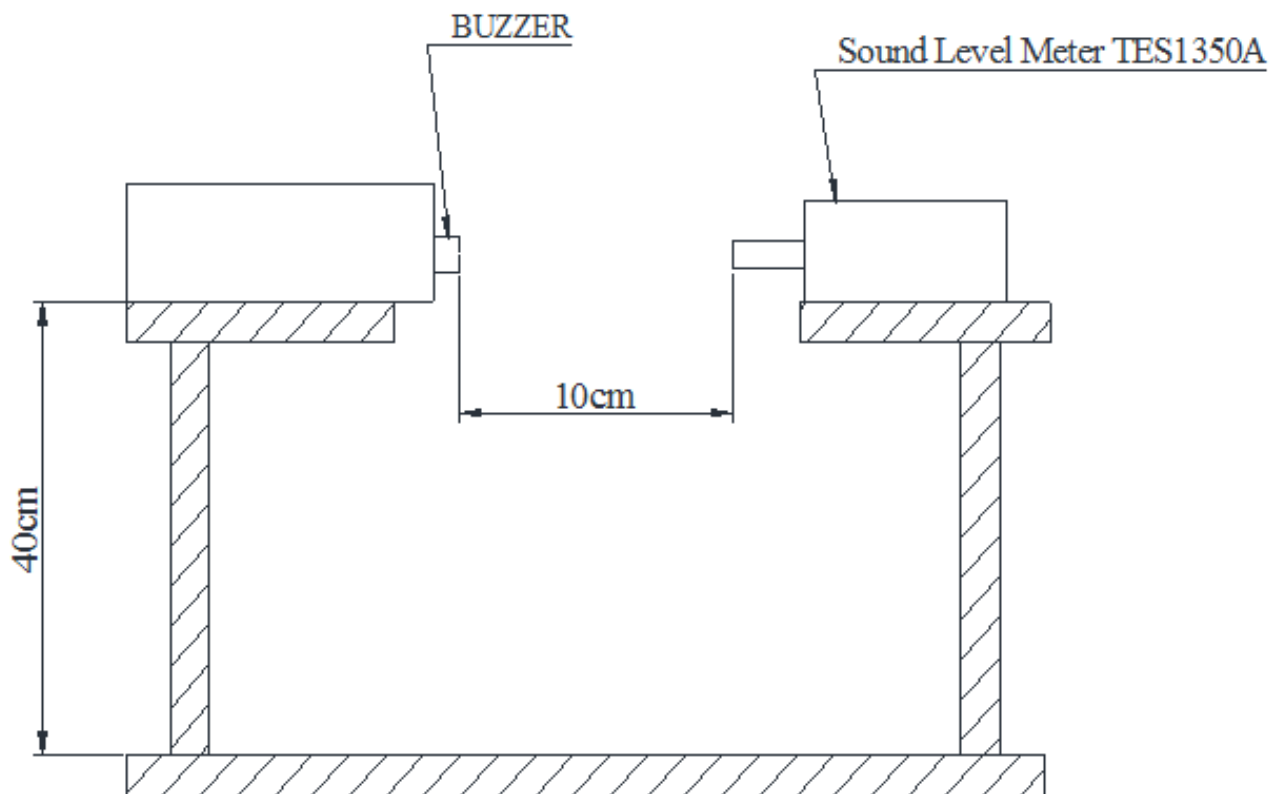



MODEL: WT-2505
PRODUCT: Electromagnetic Buzzer
EDITION: A/2017

DIMENSIONS

Tolerance:±0.5 (unit: mm)

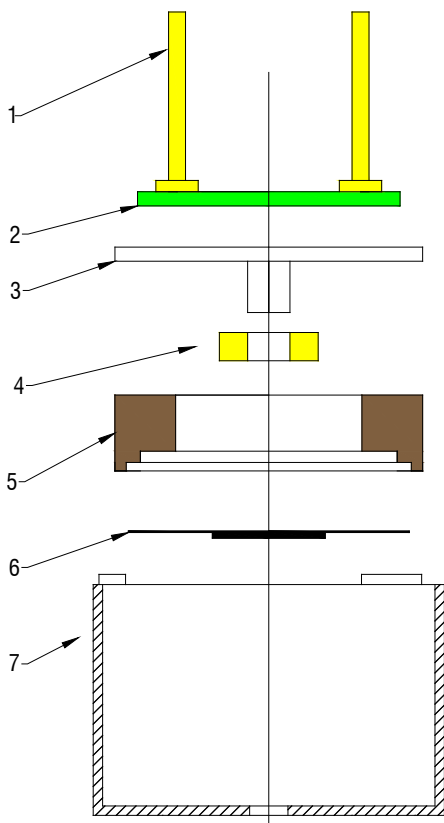
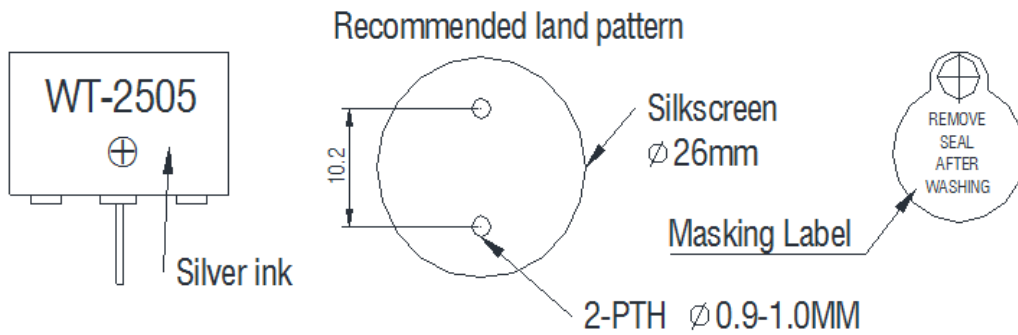
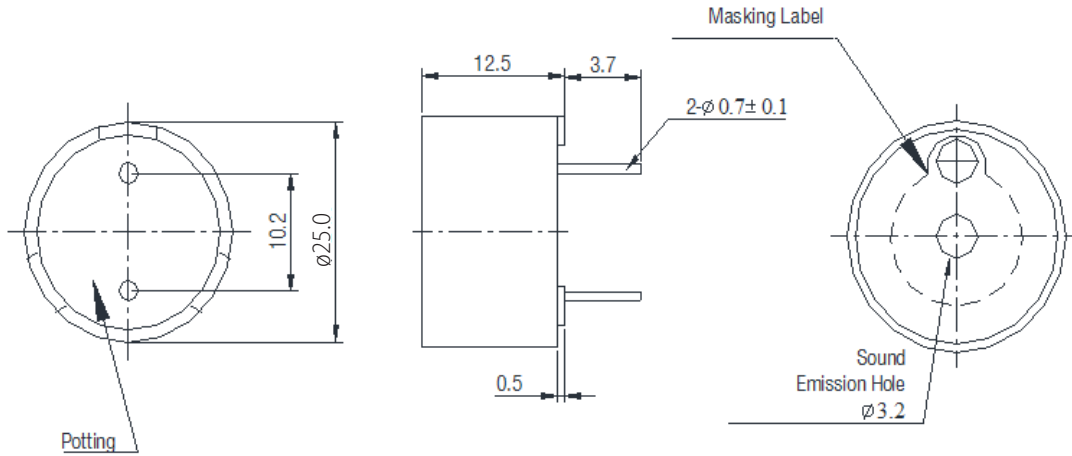

no	item	material	quantity
1	PIN	Copper	2
2	PCB	Epoxy glass fiber cloth + Copper	1
3	Core	Ferrum	1
4	Coil	Copper	1
5	Magnet ring	Poly + Ferrite	1
	Diaphragm	Ferrum	1
6	CASE	PBT	1



MODEL: WT-2505
PRODUCT: Electromagnetic Buzzer
EDITION: A/2017

PACKING

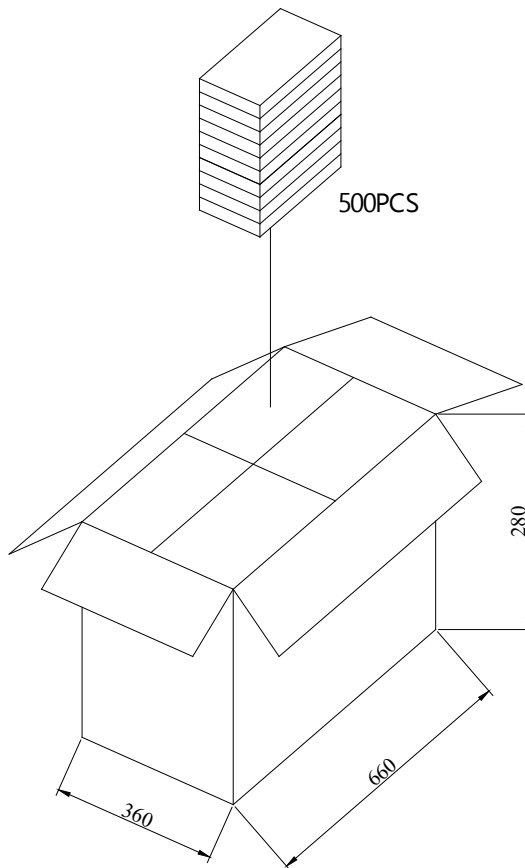
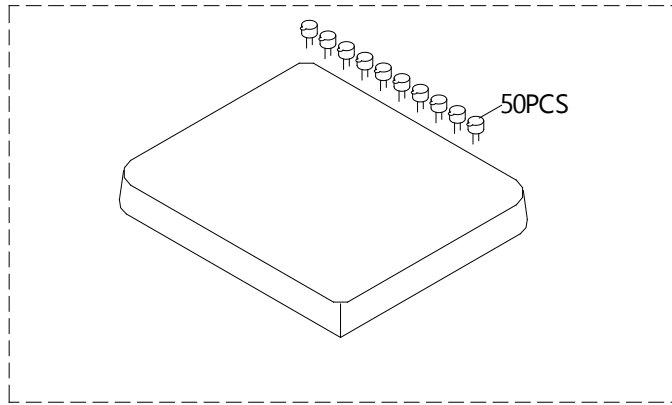

size	quantity
tray	50 pcs
inner box	500 pcs
carton box	2000 pcs